

SONIC

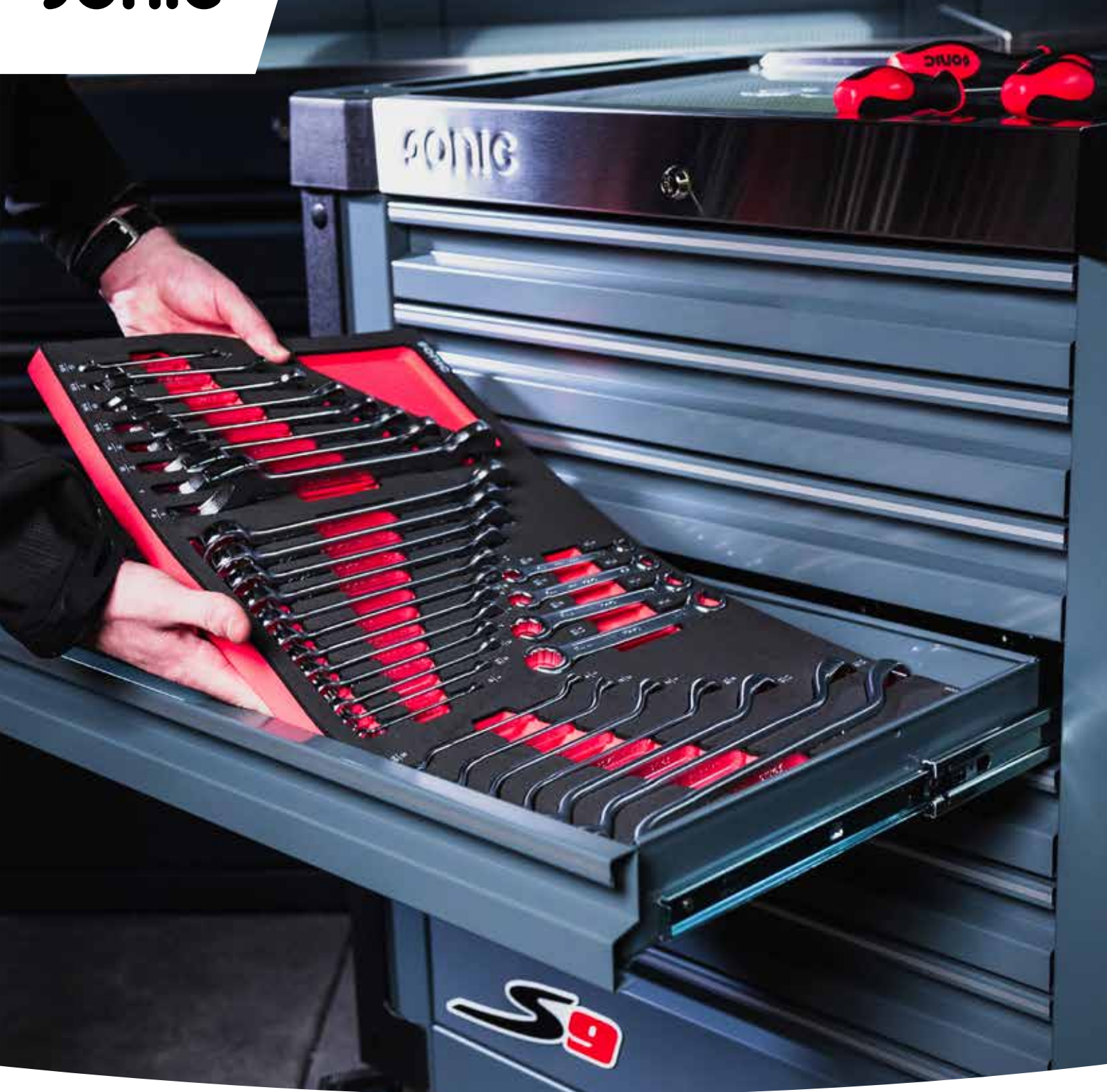

**WORK
EFFICIENT
WORK
WITH SONIC**





SONIC



***WORK
EFFICIENT
WORK
WITH SONIC***



Scan the QR-codes
in this brochure with
your smartphone for
information about the
products shown.

Our Drive.

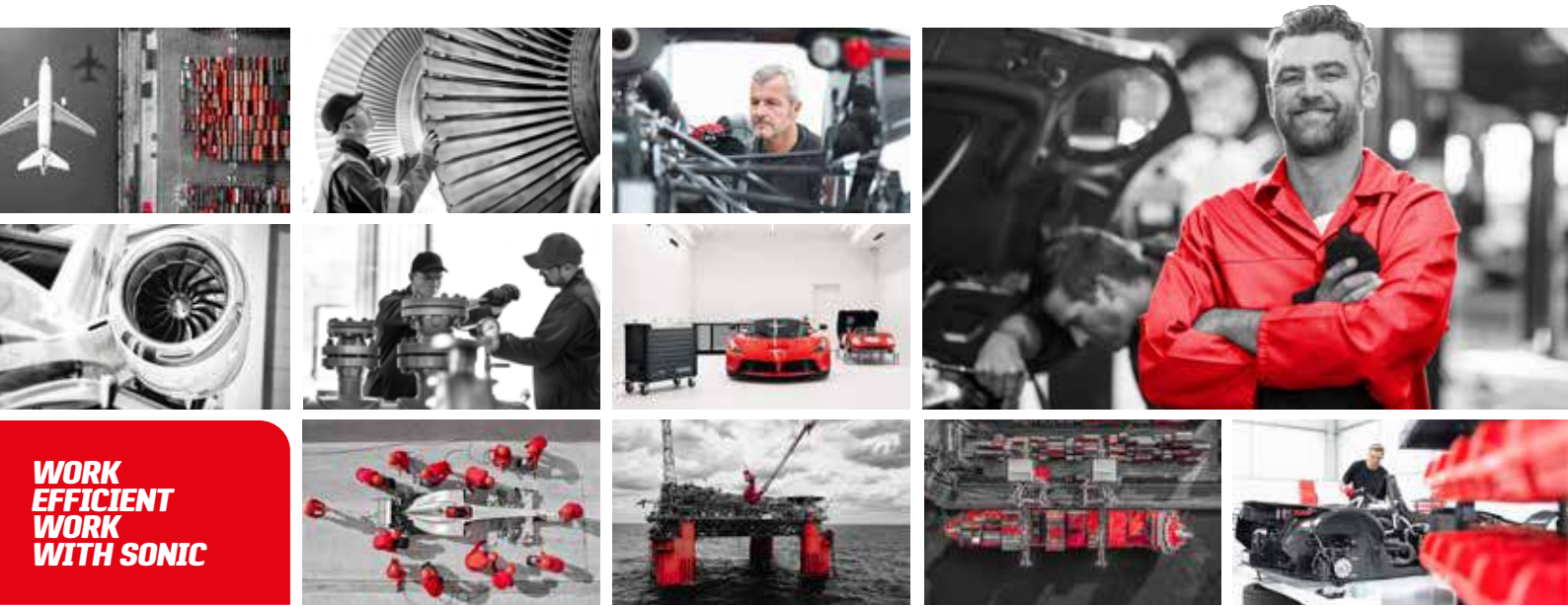

**WORK
EFFICIENT
WORK
WITH SONIC**

Inspire confidence in technical services by delivering **efficiency, style** and **support** to professionals worldwide.

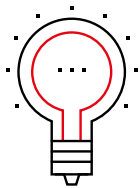

Efficiency

The perfect solution for you:

We offer the right balance between design, quality and price



Style

Join the winning team:

Our products are tested and proven by winners

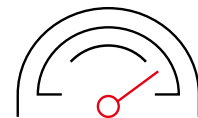

Support

We take care of you:

Our team is there to support you and always ready to go the extra mile

Our DNA.

Sonic Equipment is the specialist in high-quality hand tools, filled toolboxes and premium storage solutions. Founded in 2004 and now a leading brand with sales in more than 65 countries worldwide. In addition to Automotive, Sonic is active in the Agriculture, Truck, Industry, Maritime, Aviation, Bicycles and Motorcycles sectors.

Our goal is to provide the perfect solution for technical professionals, always with the right balance between design, quality and price. Inspiring technicians with confidence and enabling them to excel in their daily job with joy and satisfaction.

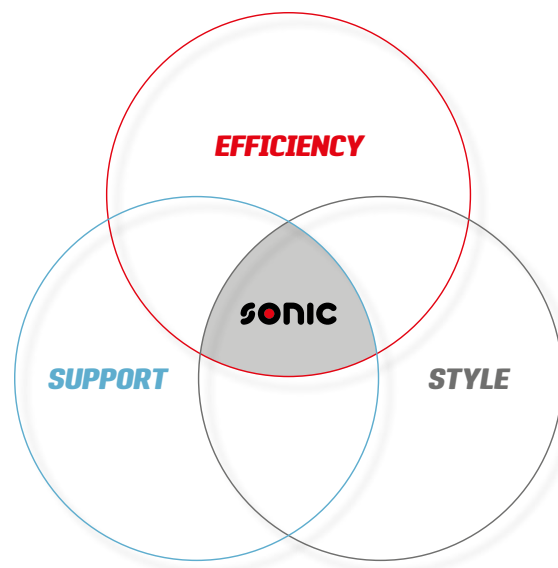

Sonic is represented in more than 65 countries worldwide

About Us.

- HQ including a 5.000m² warehouse and Sonic Experience Center located in the Netherlands
- Facilities and warehouses in Germany, France, Taiwan, Hong Kong and the United States
- Active in the Automotive, Agriculture, Truck, Industry, Maritime, Aviation Bicycles and Motorcycles sectors.



***WORK
EFFICIENT
WORK
WITH SONIC***





**WORK
EFFICIENT
WORK
WITH SONIC**

01	> Empty storage solutions PAGE 10	01
02	> Filled storage solutions PAGE 64	02
03	> Sonic Foam System (SFS) PAGE 116	03
04	> Blow Mould Case Storage (BMCS) PAGE 162	04
05	> Socket rails PAGE 176	05
06	> Tool sets PAGE 184	06
07	> Special tools PAGE 192	07
08	> Timing tools PAGE 252	08
09	> Displays PAGE 302	09
10	> Screwdrivers PAGE 310	10
11	> Sockets PAGE 316	11
12	> Wrenches PAGE 340	12
13	> Hex and TX keys PAGE 346	13
14	> Pliers, hammers, chisels, files, measuring and cutting tools PAGE 354	14
15	> Ratchets, extensions, sliding T-handles, universal joints, adaptors PAGE 372	15
16	> Torque wrenches PAGE 384	16
17	> Bit sockets and bits PAGE 390	17
18	> Promotional items PAGE 403	18
19	> Warranty PAGE 405	19

Symbols

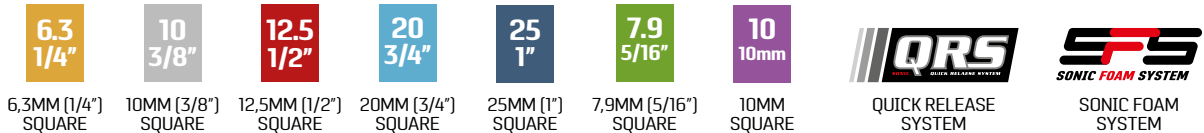
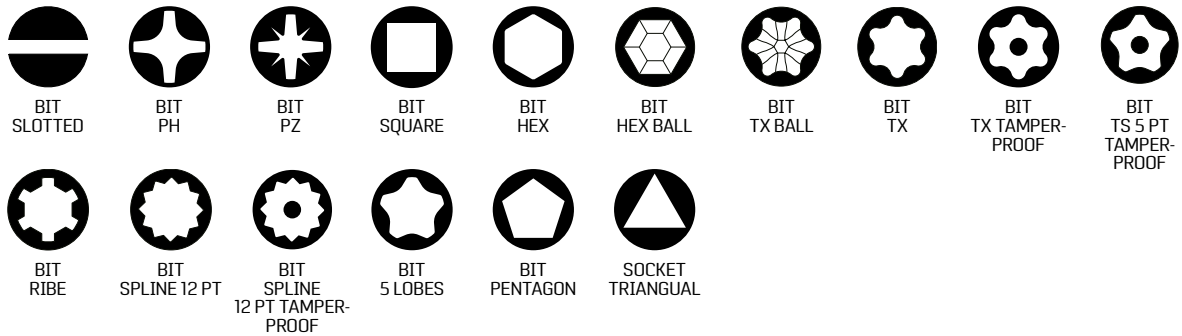
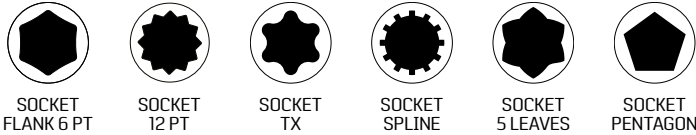

This Sonic catalog (Sonic 2022), displaces all previous catalog. All illustrations are unretouched and the tools are originating from current production or from stock. The measures given in this catalog are not binding. Whilst every effort has been made to ensure accuracy of information given in the Sonic catalog our policy of continuous improvement determines that we reserve the right to deviate from printed details without prior notice to keep pace with latest developments. Copyright: All text, photos and illustrations are protected by copyright. No part of this material may be reproduced without our written permission.

**FOLLOW THE ACTION
ON SOCIAL MEDIA**



 [sonic.equipment](https://www.instagram.com/sonic.equipment)



 [Sonic Equipment Global](https://www.facebook.com/SonicEquipmentGlobal)



 [Sonic Equipment BV](https://www.linkedin.com/company/sonic-equipment-bv)



**Watch Sonic Equipment
on YouTube**



**SIGN UP FOR
OUR NEWSLETTER**



Stay updated about our latest news, tips and tricks and supersonic product deals by subscribing to our newsletter:
www.sonic-equipment.com/newsletter



**EMPTY
STORAGE
SOLUTIONS**

Create your perfect workspace.

01 > Empty storage solutions

- 

> S7 toolbox
PAGE 12



> S14 toolbox
PAGE 23
- 

> S8 toolbox
PAGE 13



> S15 toolbox
PAGE 24
- 

> S9 toolbox
PAGE 14



> Holder for S9, S12, S12XD
PAGE 25
- 

> S9 VAS toolbox
PAGE 15



> Service carts
PAGE 27
- 

> S10 toolbox
PAGE 16



> Topboxes
PAGE 28
- 

> S10 windshield toolbox
PAGE 17



> Cases
PAGE 29
- 

> S11 toolbox
PAGE 18



> Modular Storage System plus (MSS+)
PAGE 30
- 

> S12 toolbox
PAGE 19



> Modular Storage System (MSS)
PAGE 42
- 

> S12 XD toolbox
PAGE 20



> Toolbox spare parts
PAGE 54
- 

> S12 VAS toolbox
PAGE 21
- 

> S13 toolbox
PAGE 22

Art. no. 4733716



S7 toolbox

The S7 toolbox is the perfect match for every starter or hobbyist. The toolbox is easily maneuverable, even in smaller workshops or personal garages. Despite its modest appearance, this 6-drawer toolbox can store up to 241-pcs of equipment.

● RAL 9004



THE PERFECT MATCH FOR EVERY STARTER

Main features

- Total 6 drawers
- Powder coated exterior
- ABS worktop
- 4 rubber casters (Ø100-35 mm)

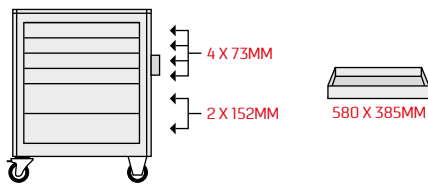

 CENTRALIZED KEYED LOCK	 BALL BEARING DRAWER SLIDES	 LOCKING CASTERS	 CAN HOLDER	 DRAWER MAX LOAD	 TOOLBOX MAX LOAD
 DRAWER 100% RETRACTABLE	 NEVER OPEN MORE THAN 1 DRAWER AT A TIME, TO PREVENT TIPPING OVER!			 KEYS	



Build your own unique S7 toolbox

Compatible with Sonic Foam System



3X 1/3 190 X 370MM



1X 570 X 370MM

Art. no. 4730167



S8 toolbox

The S8 toolbox is the perfect start for every professional. The toolbox is easily maneuverable, even in smaller workshops. Despite its modest appearance, this 7-drawer toolbox can store up to 344-pcs of equipment.

● RAL 9004



01

THE PERFECT BASE FOR EVERY PROFESSIONAL

Main features

- Total 7 drawers
- Side handle
- Powder coated exterior
- Anti-slip foam mat
- Integrated drawer lock prevents unwanted opening of the drawers
- 4 rubber casters (Ø125-50mm)

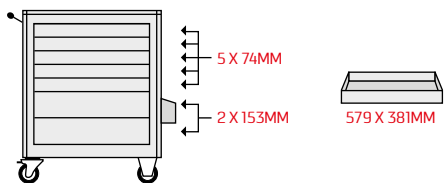

CENTRALIZED KEYED LOCK	BALL BEARING DRAWER SLIDES	LOCKING CASTERS	CAN HOLDER	SAFETY LATCH IN HANDLE	DRAWER MAX LOAD
TOOLBOX MAX LOAD	DRAWER 100% RETRACTABLE	NEVER OPEN MORE THAN 1 DRAWER AT A TIME, TO PREVENT TIPPING OVER!		KEYS	



Build your own unique S8 toolbox

Compatible with Sonic Foam System



3X 1/3 190 X 370MM



1X 570 X 370MM

Art. no. 4732418



S9 toolbox

The S9 is our most popular toolbox. This remarkable toolbox is equipped with a drawer blocking system for anti-tilt and has a modern design with a stainless-steel worktop and heavy-duty bumpers. The toolbox has large storage capacity of up to 539 pieces of equipment and is available in many different versions. A great choice for any professional.

● RAL 7011



OUR MOST POPULAR TOOLBOX

Main features

- Total 8 drawers
- Side handle
- Torsion resistant by profile construction
- Plastic edge protection
- Perforated panels to hang various accessories
- Powder coated exterior
- Paper roll holder
- 4 rubber casters (Ø125mm-50mm)

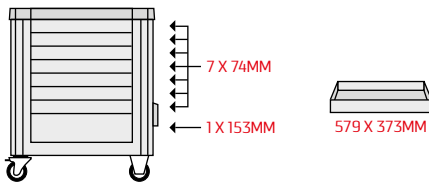

CENTRALIZED KEYED LOCK	BALL BEARING DRAWER SLIDES	LOCKING CASTERS	CAN HOLDER	304 STAINLESS STEEL WORKTOP	ANTI-TILT SYSTEM
DRAWER MAX LOAD	TOOLBOX MAX LOAD	DRAWER 100% RETRACTABLE	KEYS		



Build your own unique S9 toolbox

Compatible with Sonic Foam System



3X 1/3 190 X 370MM



1X 570 X 370MM

Art. no. ASE27600300000



S9 VAS toolbox

This remarkable S9 toolbox has a custom design for Volkswagen and equipped with a drawer blocking system for anti-tilt and has a modern design with a stainless-steel worktop and heavy-duty bumpers. The toolbox has large storage capacity of up to 539 pieces of equipment and is available in many different versions. A great choice for any professional.

● RAL 7021



01

VOLKSWAGEN CHOOSES SONIC EQUIPMENT

Main features

- Total 8 drawers
- Side handle
- Torsion resistant by profile construction
- Plastic edge protection
- Perforated panels to hang various accessories
- Powder coated exterior
- Paper roll holder
- 4 rubber casters (Ø125mm-50mm)

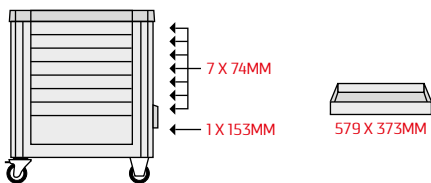

CENTRALIZED KEYED LOCK	BALL BEARING DRAWER SLIDES	LOCKING CASTERS	CAN HOLDER	304 STAINLESS STEEL WORKTOP	ANTI-TILT SYSTEM
DRAWER MAX LOAD 40 KG	TOOLBOX MAX LOAD 400 KG	DRAWER 100% RETRACTABLE	KEYS		



Compatible with Sonic Foam System



3X 1/3 190 X 370MM



1X 570 X 370MM



YOU CAN FIND MORE SETS ON OUR WEBSITE

Empty storage solutions

- Art. no. 4730918
- Art. no. 4730928
- Art. no. 4730938
- Art. no. 4730948



S10 toolbox

The S10 is a toolbox with a unique and functional design, available in four different colors. Choose your color and fill the S10 with up to 539 pieces of equipment. Not enough? The additional storage options on the side and back of the S10 toolbox provide even more convenience.

- RAL 9004
- RAL 3001
- RAL 5005
- RAL 7040



A TOOLBOX WITH A UNIQUE AND FUNCTIONAL DESIGN

Main features

- Total 8 drawers
- Torsion resistant by profile construction
- Powder coated exterior
- Plastic worktop
- 2 extra storage trays on the back
- Integrated paper roll holder
- Integrated trash can
- 4 rubber casters (Ø125mm-50mm)

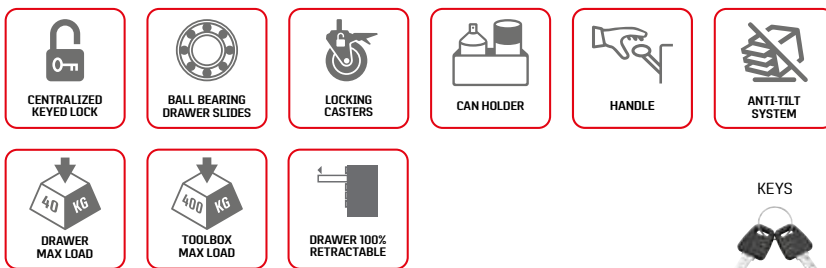
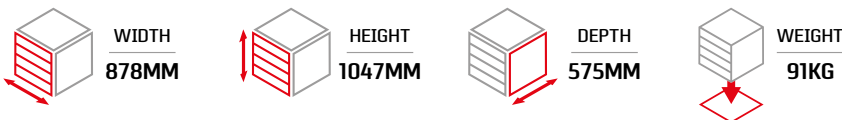
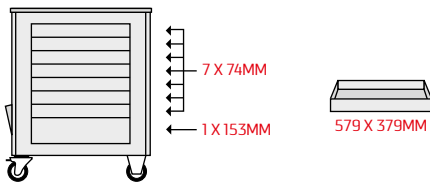

Build your own unique S10 toolbox

Compatible with Sonic Foam System



3X 1/3 190 X 370MM



1X 570 X 370MM

Art. no. 4733115



S10 windshield toolbox

The S10 windshield toolbox has a unique and functional design equipped with 5 drawers. Our S10 windshield toolbox has a high quality electrostatic powder coating in RAL 9004 black and is compatible with SFS.

● RAL 9004



01

A PERFECT TOOLBOX FOR WINDSHIELDS

Main features

- Total 5 drawers
- Adjustable windscreen holder
- Torsion resistant by profile construction
- Powder coated exterior
- Plastic worktop
- 2 extra storage trays on the back
- Integrated paper roll holder
- Integrated trash can
- 4 rubber casters (Ø125mm-50mm)

FOR WINDSHIELD SERVICE

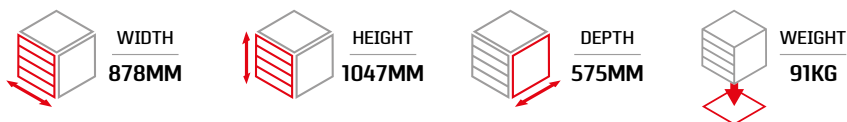
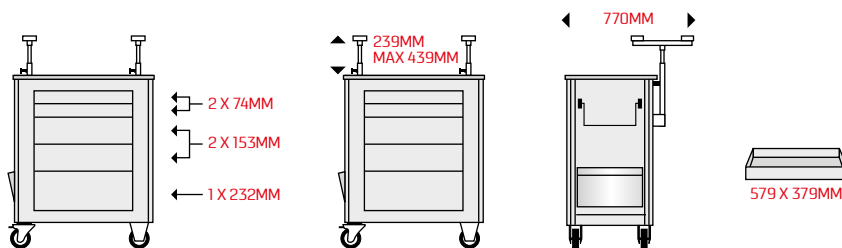

CENTRALIZED KEYED LOCK	BALL BEARING DRAWER SLIDES	LOCKING CASTERS	CAN HOLDER	HANDLE	ANTI-TILT SYSTEM
DRAWER MAX LOAD	TOOLBOX MAX LOAD	DRAWER 100% RETRACTABLE	KEYS		



Build your own unique S10 toolbox

Compatible with Sonic Foam System



3X 1/3 190 X 370MM



1X 570 X 370MM

Empty storage solutions

- Art. no. 4731118
- Art. no. 4731138
- Art. no. 4731128
- Art. no. 4731148



S11 toolbox

The S11 is a large and wide toolbox with a unique and functional design, available in four different colors. Choose your color and fill the S11 with up to 644 pieces of equipment. Not enough? The additional storage options on the side and back of the S11 toolbox provide even more convenience.

- RAL 9004
- RAL 3001
- RAL 5005
- RAL 7040



A LARGE TOOLBOX WITH A UNIQUE AND FUNCTIONAL DESIGN

Main features

- Total 8 drawers
- Torsion resistant by profile construction
- Powder coated exterior
- Plastic worktop
- 2 extra storage trays on the back
- Integrated paper roll holder
- Integrated trash can
- 4 rubber casters (Ø125mm-50mm)

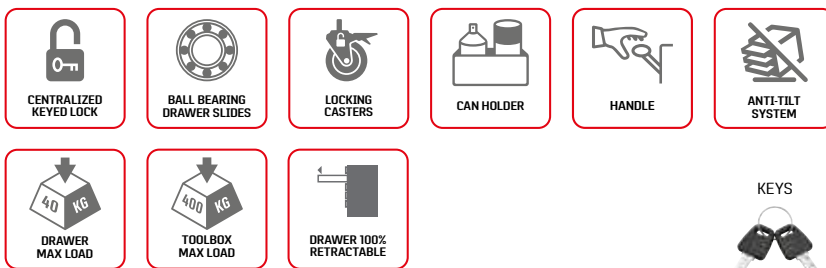
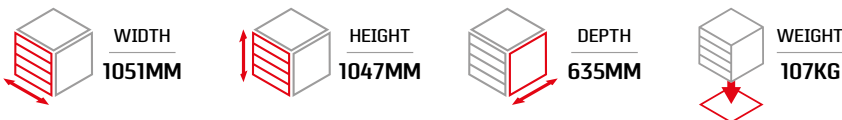
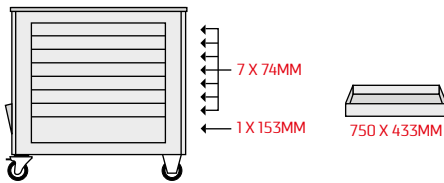

Build your own unique S11 toolbox

Compatible with Sonic Foam System



750 X 435MM

Art. no. 4732718



S12 toolbox

The S12 is a large and wide toolbox with a robust design that has been a bestseller in our range for many years. This toolbox is the perfect match for advanced technicians and can store up to 644 pieces of equipment. Despite its robust appearance the toolbox is easily maneuverable and suitable for any workplace.

● RAL 7011



01

A LARGE TOOLBOX WITH A ROBUST DESIGN

Main features

- Total 8 drawers
- Side handle
- Torsion resistant by profile construction
- Plastic edge protection
- Perforated panels to hang various accessories
- Powder coated exterior
- Paper roll holder
- 4 rubber casters (Ø125mm-50mm)

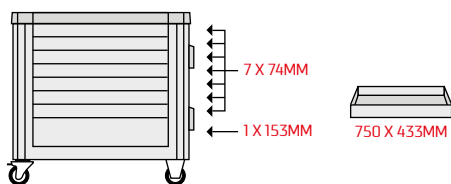

CENTRALIZED KEYED LOCK	BALL BEARING DRAWER SLIDES	LOCKING CASTERS	CAN HOLDER	304 STAINLESS STEEL WORKTOP	ANTI-TILT SYSTEM
DRAWER MAX LOAD	TOOLBOX MAX LOAD	DRAWER 100% RETRACTABLE	KEYS		



Build your own unique S11 toolbox

Compatible with Sonic Foam System



745 X 435MM

Art. no. 4734218



S12 XD toolbox

The S12XD is the extra deep and wide version of our S12. This toolbox is the perfect match for advanced technicians that want to be fully equipped for any type of job. Due to its deep drawers, the toolbox can easily store up to 735 pieces of equipment. Despite its robust appearance the toolbox is still easily maneuverable and suitable for any workplace.

● RAL 7011



EXTRA DEEP

AN EXTRA DEEP TOOLBOX WITH A ROBUST DESIGN

Main features

- Total 8 drawers
- Side handle
- Torsion resistant by profile construction
- Plastic edge protection
- Perforated panels to hang various accessories
- Powder coated exterior
- Paper roll holder
- 4 rubber casters (Ø125mm-50mm)

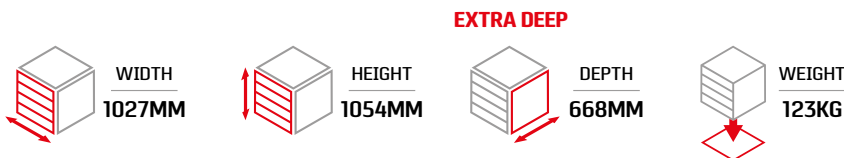
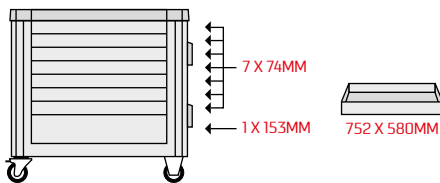

CENTRALIZED KEYED LOCK	BALL BEARING DRAWER SLIDES	LOCKING CASTERS	CAN HOLDER	304 STAINLESS STEEL WORKTOP	ANTI-TILT SYSTEM
DRAWER MAX LOAD 40 KG	TOOLBOX MAX LOAD 400 KG	DRAWER 100% RETRACTABLE	KEYS		



Build your own unique S11 toolbox

Compatible with Sonic Foam System



6X 1/3 190 X 370MM



2X 570 X 370MM



1X 745 X 435MM



1X 745 X 570MM

Art. no. ASE27600100000



S12 VAS toolbox

The S12 is a large and wide toolbox with a custom design for Volkswagen. This toolbox is the perfect match for advanced technicians and can store up to 644 pieces of equipment. Despite its robust appearance the toolbox is easily maneuverable and suitable for any workplace.

● RAL 7021



01

VOLKSWAGEN CHOOSES SONIC EQUIPMENT

Main features

- Total 8 drawers
- Side handle
- Torsion resistant by profile construction
- Plastic edge protection
- Perforated panels to hang various accessories
- Powder coated exterior
- Paper roll holder
- 4 rubber casters (Ø125mm-50mm)

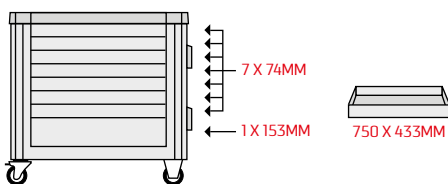

CENTRALIZED KEYED LOCK	BALL BEARING DRAWER SLIDES	LOCKING CASTERS	CAN HOLDER	304 STAINLESS STEEL WORKTOP	ANTI-TILT SYSTEM
DRAWER MAX LOAD 40 KG	TOOLBOX MAX LOAD 400 KG	DRAWER 100% RETRACTABLE	KEYS		



Compatible with Sonic Foam System



IX 745 X 435MM



YOU CAN FIND MORE SETS ON OUR WEBSITE

Art. no. 47308113



S13 toolbox

The S13 is the go-to solution for heavy duty professionals. A large toolbox with a unique and functional design, equipped with 13 drawers and a wooden workbench on top. This toolbox is a real eyecatcher and can truly change the appearance of your workplace. The most complete S13 in our range has 540 pieces of equipment and offers plenty of additional storage capacity to further extend the tools selection to your preference.



● RAL 9004

A LARGE TOOLBOX WITH A WOODEN WORKBENCH

Main features

- Total 13 drawers
- Side handle
- Torsion resistant by profile construction
- Document holder
- Powder coated exterior
- Paper roll holder
- Trash can
- 4 rubber casters (Ø150mm-51mm)

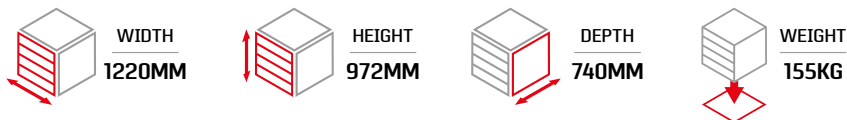
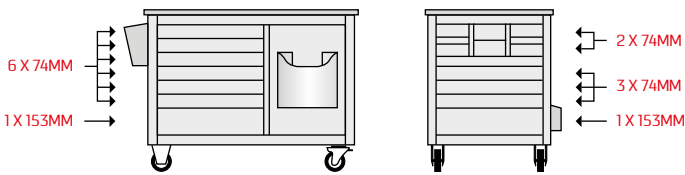

CENTRALIZED KEYED LOCK	BALL BEARING DRAWER SLIDES	LOCKING CASTERS	CAN HOLDER	WOODEN WORKTOP	ANTI-TILT SYSTEM
DRAWER MAX LOAD	TOOLBOX MAX LOAD	DRAWER 100% RETRACTABLE	KEYS		

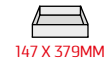

147 X 379MM



577 X 379MM



Build your own unique S13 toolbox

Compatible with Sonic Foam System



3X 1/3 190 X 370MM



1X 570 X 370MM

Art. no. 47307118



S14 toolbox

The S14 is the perfect combination of a large toolbox with plenty of storage capacity and a wooden workbench on top. This toolbox is a real eye-catcher and can change the appearance of your workplace. The 18 drawers can store up to 958 pieces of equipment.



● RAL 9004

01

A LARGE TOOLBOX WITH A LOT OF STORAGE POSSIBILITIES

Main features

- Total 18 drawers
- Heavy duty side handle
- Torsion resistant by profile construction
- Integrated paper roll holder
- 4 rubber casters (Ø150mm-51mm)

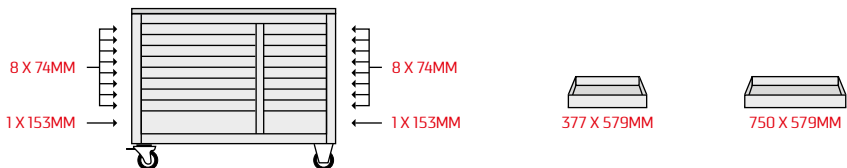

CENTRALIZED KEYED LOCK	BALL BEARING DRAWER SLIDES	LOCKING CASTERS	CAN HOLDER	WOODEN WORKTOP	ANTI-TILT SYSTEM
DRAWER MAX LOAD 40 KG	TOOLBOX MAX LOAD 600 KG	DRAWER 100% RETRACTABLE	KEYS		



Build your own unique S14 toolbox

Compatible with Sonic Foam System

6X 1/3 190 X 370MM

2X 570 X 370MM

1X 745 X 435MM

1X 745 X 570MM

Art. no. 47338114



S15 toolbox

The S15 is the biggest toolbox in our range. Featuring 14 drawers of which one broad drawer across the entire length of the box and twelve normal drawers that can store up to 958 pieces of equipment combined. The S15 is the perfect match for the most experienced technicians, who are up for any challenge.



● RAL 9004

AN EXTREME LARGE TOOLBOX WITH TONS OF STORAGE POSSIBILITIES

Main features

- Total 14 drawers
- Torsion resistant by profile construction
- Powder coated exterior
- Integrated paper roll holder
- 4 rubber casters (Ø150mm-51mm)

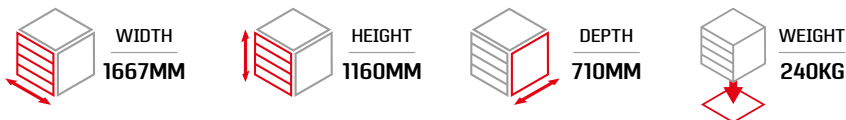
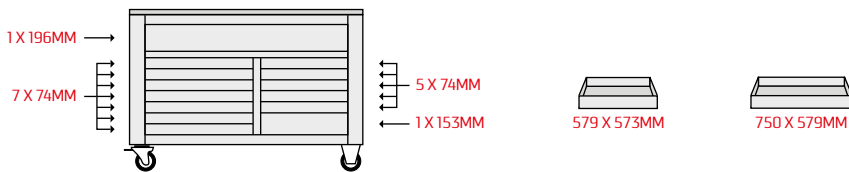

CENTRALIZED KEYPED LOCK	BALL BEARING DRAWER SLIDES	LOCKING CASTERS	CAN HOLDER	304 STAINLESS STEEL WORKTOP	ANTI-TILT SYSTEM
DRAWER MAX LOAD 40 KG	TOOLBOX MAX LOAD 600 KG	DRAWER 100% RETRACTABLE	KEYS		



Build your own unique S15 toolbox

Compatible with Sonic Foam System



6X 1/3 190 X 370MM

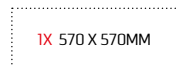

1X 570 X 570MM



2X 570 X 370MM



1X 745 X 435MM



1X 745 X 570MM

Various holders including base for **S9, S12 and S12XD**



Art. no 47725
Laptop holder



Art. no 47726
Tablet holder



Art. no 47727
Screen holder



Art. no 47728
Laptop holder including base



Art. no 47729
Tablet holder including base



Art. no 47730
Screen holder including base

The ideal solution for flexible professionals. Providing better computer ergonomics and an improved working environment.

- Aluminium alloy material
- Instant height adjustment
- Securely grips laptop with quick attach and release



Art. no 47724
Base for laptop, tablet, screen

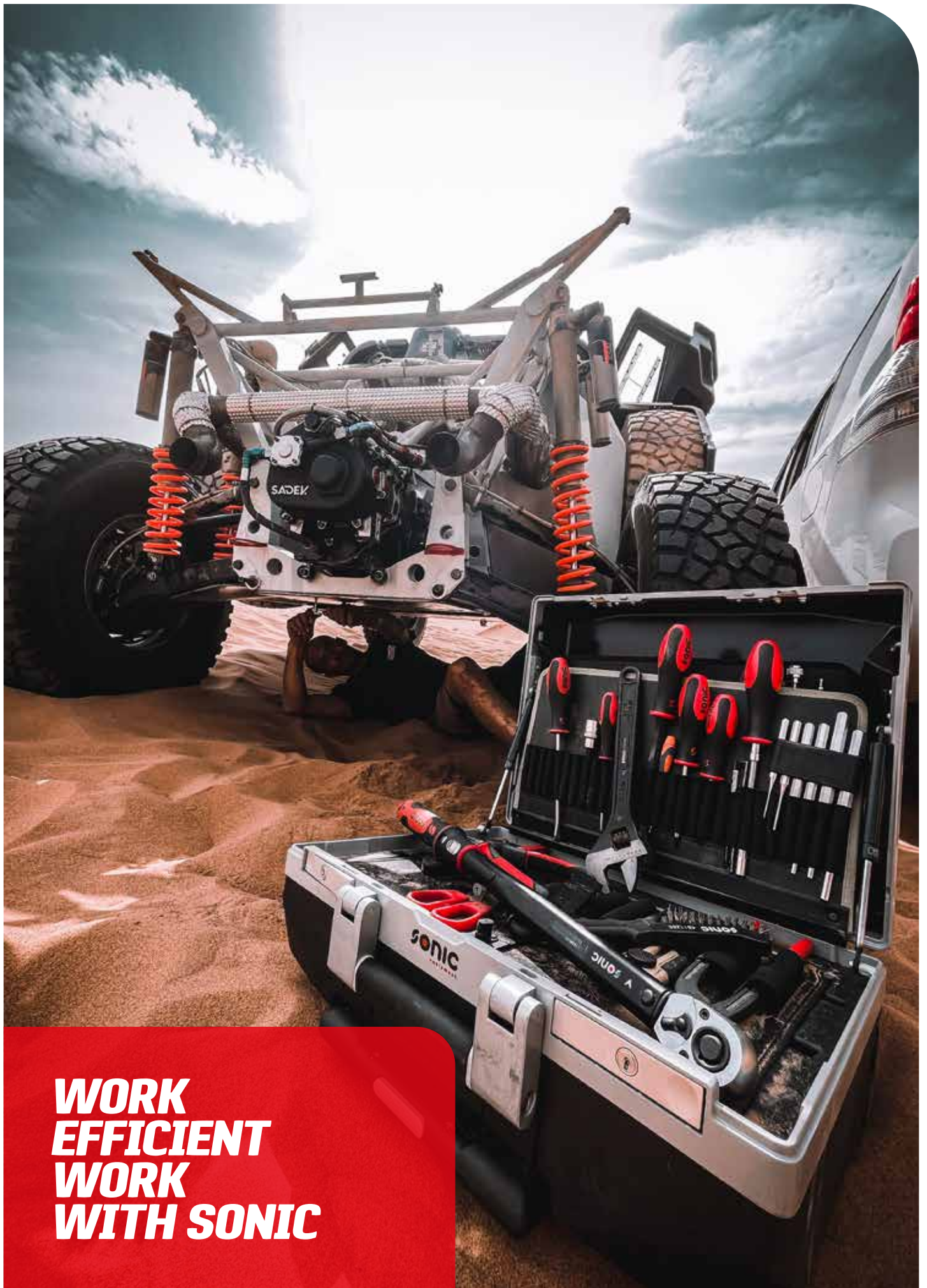

**WORK
EFFICIENT
WORK
WITH SONIC**

OTHER STORAGE SOLUTIONS TO WORK EFFICIENTLY

01

Art. no. 4732013

Service cart XL 3 drawers black

Main features

4 rubber casters (Ø100-35mm)

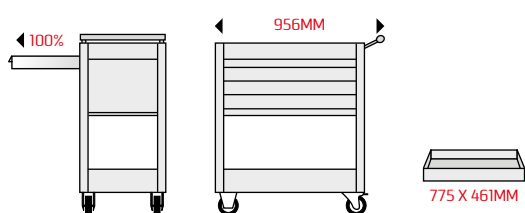

WIDTH
860MM

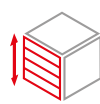

HEIGHT
998,5MM



DEPTH
500MM



WEIGHT
51,5KG



CENTRALIZED
KEYED LOCK



BALL BEARING
DRAWER SLIDES



POWDER COATING
EXTERIOR



Art. no. 4732110

Service cart XL black

Main features

4 rubber casters (Ø100-35mm)

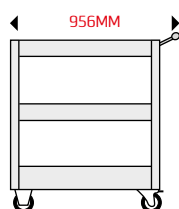

WIDTH
860MM

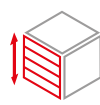

HEIGHT
998,5MM



DEPTH
500MM



WEIGHT
32,5KG



CENTRALIZED
KEYED LOCK



POWDER COATING
EXTERIOR



Empty storage solutions

Art. no. 4730414



Service topbox 4 drawers

01

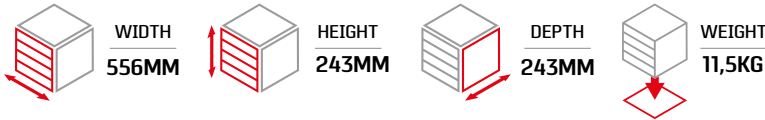
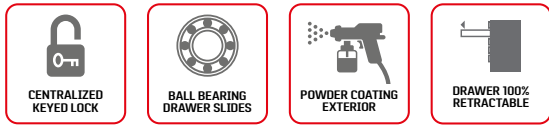

● RAL 7011



496 X 202MM

XS
472 X 202MM

Art. no. 4730434

Service topbox 4 drawers and lid

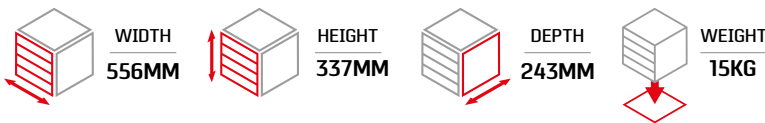

● RAL 7011



496 X 202MM

XS
472 X 202MM

Art. no. 4730224

Empty topbox S9 4 drawers

Art. no. 4733210

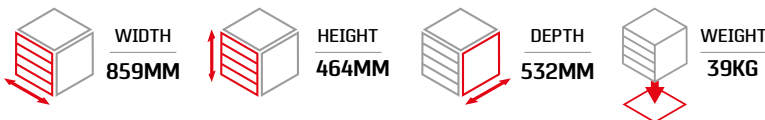
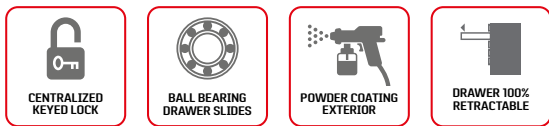

● RAL 7011



SSS
1/3 190 X 370MM

577 X 377MM

M
1X 570 X 370MM

Art. no. 4733014

Empty topbox trolley 4 drawers

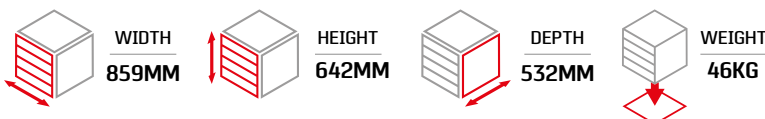
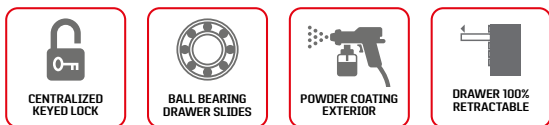

● RAL 7011



SSS
1/3 190 X 370MM

577 X 377MM

M
1X 570 X 370MM

Art. no. 4730415

Toolbox

Main features

- Sheet thickness cover 0,6mm, sheet thickness box 0,55mm
- Piano hinged cover
- 'Sonic' print in both lower trays in the left corner of the long sides
- Powder coated exterior

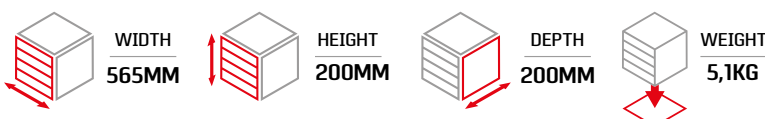

● RAL 9017



Art. no. 47502 (made in EU)

Empty portable case **XL**

Tool case with 78 elastic tool holders and a bottom tray for subdivision. Features 11 tool holders in the tray cover and 2 inserts within the tray itself. In the tool case there is a double-sided tool panel with 28+17 tool holders and a document holder.

Main features

- Material: ABS-hard shell case, protects case and content
- 2 cylinder key-locks integrated in frame

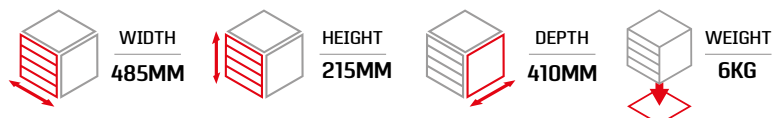

Art. no. 47503 (made in EU)

Empty portable case trolley **XL**

Portable tool case with 79 elastic tool holders and a bottom tray for subdivision. Features 11 tool holders in the tray cover and an assortment of 5 inserts within the tray itself. In the tool case there is a double-sided tool panel with 28+17 tool holders plus a further single-sided panel with 23 tool holders and a document holder.

Main features

- Material: ABS-hard shell case, protects case and content
- 2 cylinder key-locks integrated in frame

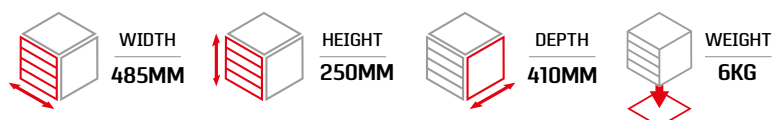



Premium workplaces, ultimate workflow.

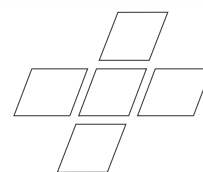

MSS+ is our pride when it comes to modular storage solutions. This high-quality product line is designed for the true professional who accepts nothing less than the best. The system can be configured modularly with a variety of modules, elements and specifications. The setup can be completed with Sonic's Foam System (SFS), ensuring you will always have the right tools, in the right composition, efficiently arranged in the setup. With MSS+, you create the perfect workplace in every workshop. An ultimate workflow and maximum job satisfaction guaranteed.



Self-supporting system

- Compatible to every working area - walls no longer needed
- Designed to endure long-term intensive use
- All modules are made from a high quality 1.4mm steel construction
- Easily adjustable in height
- Available in RAL 7016 color



Drawers

- Maximized drawer storage capacity
- Less strain on the drawer and module, resulting in an improved lifetime
- Multiple drawer configurations available
- 100% retractable drawers
- Ergonomic handles for the perfect grip
- High drawers are equipped with ventilation slots
- Bottom drawers include integrated power bar with 2x USB and 4x 110V/230V (mobile cabinets excluded)



Drawer blocking system

- Prevents opening multiple drawers at the same time
- Prevents tipping over
- Closed drawers function as counterweight to stabilize entire cabinet



Secure combination locks

- Combination locks on every module to secure tools and other valuables
- Freely programmable code, adjustable whenever needed

Premium features

Worktops

01

- Wide range of composite and stainless steel worktops
- 2mm composite worktops
- 20mm stainless steel worktops
- Easy to clean
- Resistant to the most common fluids

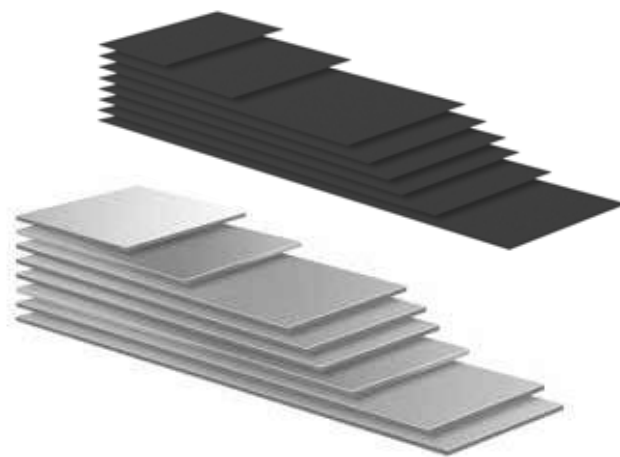

Sonic Foam System

- Customize drawer content with the unique Sonic Foam System
- Efficient organization of complete tool sets
- Two-tone foam color system for instant overview of missing tools
- Oil and chemical resistant
- Tool specifications visible on the foam inlay



Lighting

- Latest LED lighting technology
- Magnetic mountable under wall cabinet
- Increase productivity with a perfectly lit work surface
- Energy efficient and extremely long-lasting lighting
- Maximum connection circuit of 4 LED lights on 1 transformer



Unique powder coating

- Premium finish due to the use of high-quality materials
- Electro-static powder coating in RAL 7016 for great looks and highly durable protection
- Durable protection against scratches, wear and corrosion



Slides



- Highest quality heavy-duty slides available on the market, featuring 123kg or 230kg load capacity
- Telescopic ball bearing system
- Maximum reliability, precision and smooth conduction over the entire lifespan of the MSS+ module

* Mobile drawer cabinets are equipped with standard drawer slides with a carrying capacity of 40kg or 80kg per drawer.



Handles and end caps

- High-quality handles for optimal ergonomics, based on extensive prototyping
- Unique MSS+ handle, including caps with the iconic Sonic S-logo
- The extra ridge under the handle provides a perfect grip

Power supply



- Convenience in powering and charging tools
- Included as standard in drawer cabinets and wall cabinets (mobile cabinets excluded)
- Equipped with protective caps
- Equipped with 2 USB ports and 4x 110V/230V

Dividers



- Ultimate organization for drawers
- Modular system to design your own drawer layout
- Efficient storage of tools and other items of all sizes

Drawer cabinets

01



5072001 (EU power bar)
720mm drawer cabinet,
8 drawers



5072002 (EU power bar)
720mm drawer cabinet,
6 drawers



5089001 (EU power bar)
890mm drawer cabinet,
8 drawers



5089002 (EU power bar)
890mm drawer cabinet,
6 drawers



5072018 (EU power bar)
720mm drawer cabinet,
3 drawers



5089015 (EU power bar)
890mm drawer cabinet,
3 drawers



5153901 (EU power bar)
1540mm drawer cabinet,
12 drawers

Portable cabinets



5072004
700mm portable cabinet extra deep,
7 drawers



5072005
700mm portable cabinet,
7 drawers



5089004
870mm portable cabinet extra deep,
7 drawers



5089005
870mm portable cabinet,
7 drawers



5089011
890mm service cart



• 5999937 back panel for bridge unit
720mm, 657x740mm
• 5999938 back panel for bridge unit
890mm, 827x740mm

Storage cabinets



5036001
360mm storage cabinet,
left-handed door
5036002
360mm storage cabinet,
right-handed door



5072009
720mm storage cabinet,
left-handed door
5072010
720mm storage cabinet,
right-handed door



5089009
890mm storage cabinet, double door



5106002
1060mm corner storage cabinet,
double door



5072011
720mm cabinet with sink,
double door



5072012
720mm waste bin/recycle cabinet

Reel cabinets



5036003
360mm reel cabinet



5072007
720mm reel cabinet



5089007
890mm reel cabinet



5071801
650mm reel tall cabinet

Wall cabinets



5071802 (EU power bar)
720mm wall cabinet



5082001 (EU power bar)
820mm wall cabinet

Back panels



• 5999901 Blank back panel, 259x50x120mm
• 5999902 Blank back panel, 619x50x120mm
• 5999903 Blank back panel, 719x50x120mm
• 5999904 Blank back panel, 789x50x120mm
• 5999930 Blank back panel, 959x50x120mm corner



• 5999913 Blank back panel, 259x50x552mm
• 5999905 Blank back panel, 619x50x552mm
• 5999906 Blank back panel, 719x50x552mm
• 5999907 Blank back panel, 789x50x552mm
• 5999931 Blank back panel, 959x50x552mm corner



• 5999908 Blank back panel, 259x50x1104mm
• 5999909 Blank back panel, 619x50x1104mm
• 5999910 Blank back panel, 719x50x1104mm
• 5999911 Blank back panel, 789x50x1104mm
• 5999934 Blank back panel, 959x50x1104mm corner
• 5999912 Blank back panel for monitor and keyboard, 619x50x1104mm



• 5999922 Square perforated back panel, 259x50x552mm
• 5999923 Square perforated back panel, 619x50x552mm
• 5999924 Square perforated back panel, 719x50x552mm
• 5999925 Square perforated back panel, 789x50x552mm
• 5999933 Square perforated back panel, 959x50x552mm corner



5072003
720mm topbox, 5 drawers



5089003
750mm topbox, 5 drawers

Posts

- 5999401 Post 50x50x1020mm
- 5999402 Post 100x50x1020mm
- 5999403 Post 100x50x1016mm for portable cabinet, right
- 5999404 Post 100x50x1016mm for portable cabinet, left
- 5999405 Post 50x50x1997mm
- 5999406 Post 100x50x1997mm
- 5999407 Post 100x50x1993mm for portable cabinet, right
- 5999408 Post 100x50x1993mm for portable cabinet, left



Worktops

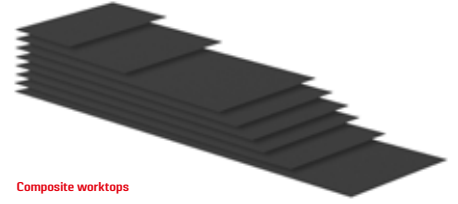

- Composite worktops**
- 5999801 Composite worktop 360x650x2mm
 - 5999802 Composite worktop 720x650x2mm
 - 5999803 Composite worktop 890x650x2mm
 - 5999804 Composite worktop 1440x650x2mm (720-720mm)
 - 5999805 Composite worktop 1540x650x2mm
 - 5999806 Composite worktop 1610x650x2mm (720-890mm)
 - 5999807 Composite worktop 1780x650x2mm (890-890mm)
 - 5999808 Composite worktop 2160x650x2mm (720-720-720mm)
- Thickness 2mm, depth 650mm

- Composite worktops for portable cabinet**
- 5999021 Composite worktop, portable cabinet 863x655x2mm
 - 5999043 Composite worktop, portable cabinet 686x523x2mm
 - 5999044 Composite worktop, portable cabinet 856x523x2mm
 - 5999045 Composite worktop, portable cabinet 693x655x2mm



- Stainless steel worktop**
- 5999701 Stainless steel worktop 360x650x20mm
 - 5999702 Stainless steel worktop 720x650x20mm
 - 5999703 Stainless steel worktop 890x650x20mm
 - 5999704 Stainless steel worktop 1441x650x20mm (720-720mm)
 - 5999705 Stainless steel worktop 1540x650x20mm
 - 5999706 Stainless steel worktop 1611x650x20mm (720-890mm)
 - 5999707 Stainless steel worktop 1781x650x20mm (890-890mm)
 - 5999708 Stainless steel worktop 2162x650x20mm (720-720-720mm)
 - 5999711 Stainless steel worktop 2261x650x20mm (720-1540mm)
 - 5999712 Stainless steel worktop 2332x650x20mm (720-720-890mm)
 - 5999709 Stainless steel worktop 2431x650x20mm (890-1540mm)
- Thickness 20mm, depth 650mm

- Stainless steel worktop, portable cabinet**
- 5999601 Stainless steel worktop, portable cabinet 700x530x20mm
 - 5999602 Stainless steel worktop, portable cabinet 700x600x20mm
 - 5999603 Stainless steel worktop, portable cabinet 870x530x20mm
 - 5999604 Stainless steel worktop, portable cabinet 870x660x20mm
- Thickness 20mm



- Corner worktops**
- 5999809 Composite worktop 1060x1060x2mm
 - 5999710 Stainless steel worktop 1060x1060x20mm



- Wooden worktop**
- 5999501 Wooden worktop 1780x650x40mm
- Thickness 40mm, depth 650mm

Bridge units

- 5070001 700mm bridge unit
- 5072006 720mm bridge unit
- 5089006 890mm bridge unit
- 5106001 1060mm bridge unit
- 5089013 890mm bridge unit with writing desk



Optional:
Full range of colors upon request, longer lead time and additional fees could apply.



5089012
890mm waste bin cabinet



5065501
650mm tall cabinet, left-handed door
5065502
650mm tall cabinet, right-handed door



5096501
965mm tall storage cabinet, double door



5089010 (EU power bar)
890mm wall cabinet



5072008 (EU power bar)
720mm wall cabinet with tambour door



5089008 (EU power bar)
890mm wall cabinet with tambour door



5072015
Wall cabinet with PC/laptop storage



- 5999926 Square perforated back panel, 259x50x1104mm
- 5999927 Square perforated back panel, 619x50x1104mm
- 5999928 Square perforated back panel, 719x50x1104mm
- 5999929 Square perforated back panel, 789x50x1104mm
- 5999936 Square perforated back panel, 959x50x1104mm corner



- 5999937 Back panel for bridge unit 720mm, 657x740mm
- 5999927 Back panel for bridge unit 890mm, 827x740mm

Dividers



5999305

Divider kit for 720mm cabinet contains:

- 3 pcs MSS+ divider slot vertical [5999312]
- 2 pcs MSS+ divider slot vertical for the side [5999313]
- 2 pcs MSS+ divider slot horizontal [5999310]
- 4 pcs MSS+ divider spacer horizontal 88.60mm [5999307]
- 4 pcs MSS+ divider spacer horizontal 182.30mm [5999308]



5999318

Divider kit for 700mm portable cabinet contains:

- 3 pcs MSS+ divider slot vertical [5999314]
- 2 pcs MSS+ divider slot vertical for the side [5999315]
- 2 pcs MSS+ divider slot horizontal [5999310]
- 4 pcs MSS+ divider spacer horizontal 88.60mm [5999307]
- 4 pcs MSS+ divider spacer horizontal 182.30mm [5999308]



5999306

Divider kit for 890mm cabinet contains:

- 3 pcs MSS+ divider slot vertical [5999312]
- 2 pcs MSS+ divider slot vertical for the side [5999313]
- 2 pcs MSS+ divider slot horizontal [5999311]
- 4 pcs MSS+ divider spacer horizontal 88.60mm [5999307]
- 4 pcs MSS+ divider spacer horizontal 182.30mm [5999308]



5999319

Divider kit for 870mm portable cabinet contains:

- 3 pcs MSS+ divider slot vertical [5999316]
- 2 pcs MSS+ divider slot vertical for the side [5999317]
- 2 pcs MSS+ divider slot horizontal [5999311]
- 4 pcs MSS+ divider spacer horizontal 88.60mm [5999307]
- 4 pcs MSS+ divider spacer horizontal 182.30mm [5999308]
- 2 pcs MSS+ divider spacer horizontal 369.76mm [5999309]

Lighting



- LED light length: 600mm**
- 800-1000 Lm
 - Color temperature: 6000-6500k
 - Aluminium base + pc cover
 - Mounting magnet included
- LED light length: 800mm**
- 800-1000 Lm
 - Color temperature: 6000-6500k
 - Aluminium base + pc cover
 - Mounting magnet included

660

- 5999201
LED light, length 600mm
- 5999202
LED light, length 800mm
- 5999204
Adaptor for LED light, EU plug
- 5999205
Connector with switch for LED light
- 5999206
LED light 600mm (EU) with adaptor+connector
- 5999208
LED light 800mm (EU) with adaptor+connector

- Features**
- Find what you are looking for faster, without relying on surrounding lighting
 - The latest technology is used
 - Magnetic mountable under wall cabinet
 - Increase your productivity with a perfectly lit work surface
 - Energy efficient and extremely long lasting
 - Maximum connection, circuit of 4 LED lights

Document holder



- 5999061
Measurements: 560mm wide, 40mm deep, 314mm high
- Convenient holder to store documents laptop or tablet
- Safety protection on all edges
- High quality 1.0mm steel construction

Power supply



660

5999302 **Power bar**

The MSS+ high performance power bars features a tough, anodized aluminium extrusion ensuring strength and durability.

- Features**
- Durable abs and aluminium housing
 - 4 grounded outlets
 - 2 USB outlets
 - Lighted reset/off switch
 - 5m cord
 - Ergonomically designed, profiled body - robust and easy to grip
 - Rugged anodised aluminium extrusion - lightweight and strong
 - Pa6 nylon moulded outlets and endcaps - protects and insulates power supply
 - High grade polychloropreen/neoprene rubber cable (oil, chemical and ozon resistant)
 - Color RAL 7016

Remark
Cabinets with fixed drawers include power bar in bottom drawer.

5999301 **Power bar bracket**

- Angled power bar bracket can be mounted on the back panel
- Angle to the bracket provides clearance for cable leads and plugs bar
- The power bar bracket sits inside the backface of the post, this allows a back-to-back low level solution

Laptop/tablet holder



- 5999304
Measurements: 447mm wide, 158mm deep, 365mm high
- Convenient holder for tablet/laptop
- Multifunctional
- Tilt function
- Mountable on back panels
- High quality 1.2mm steel construction

Setups

01



Art. no. 5770006 **Composite worktop**
Art. no. 5771106 **Stainless steel worktop**



Art. no. 5770004 **Composite worktop**
Art. no. 5771104 **Stainless steel worktop**



Art. no. 5770002 **Composite worktop**
Art. no. 5771102 **Stainless steel worktop**



Art. no. 5770001 **Composite worktop**
Art. no. 5771101 **Stainless steel worktop**



Art. no. 5770003 **Composite worktop**
Art. no. 5771103 **Stainless steel worktop**



Art. no. 5881106 **Stainless steel worktop**



Art. no. 5770005 **Composite worktop**
Art. no. 5771105 **Stainless steel worktop**



Art. no. 5771107 **Stainless steel worktop**



Art. no. 5880003 Composite worktop
Art. no. 5881103 Stainless steel worktop



Art. no. 5880001 Composite worktop
Art. no. 5881101 Stainless steel worktop



Art. no. 5880002 Composite worktop
Art. no. 5881102 Stainless steel worktop



Art. no. 5880004 Composite worktop
Art. no. 5881104 Stainless steel worktop



Art. no. 5880005 Composite worktop
Art. no. 5881105 Stainless steel worktop



Art. no. 5660001 Wooden worktop

Sonic MSS+ 3D configurator

Our MSS+ 3D configurator app offers the possibility to design the perfect workplace for your workshop. We create the ultimate workflow with our modular MSS+ elements and arrange everything from planning to design and delivery in your workshop.

Interested? Contact our Sonic Support Team or enquire at your regular Sonic dealer.

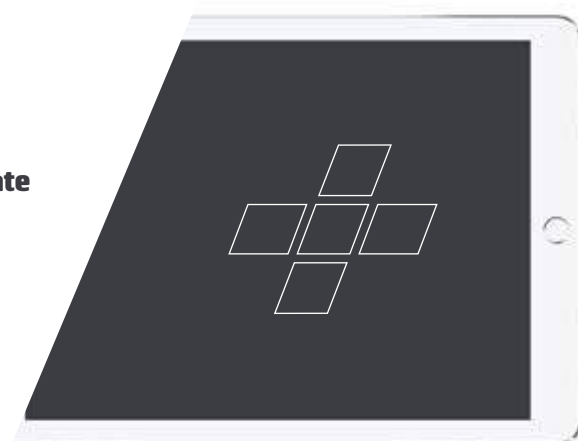



**WORK
EFFICIENT
WORK
WITH SONIC**





Get organized, be efficient. The **ultimate** Sonic workplace



EXTRA DEEP WORKTOP
THROUGH SPACER



MSS IS ADJUSTABLE
IN HEIGHT



COMPATIBLE WITH SFS











Improve your image, **productivity & efficiency**



● RAL 9004 ● RAL 9006

Create your ultimate workplace with the Sonic Modular Storage System (MSS). All MSS modules are separately available and can be easily assembled. All modules are suitable for the Sonic Foam System (SFS). Next to this, MSS is a self-supporting system so walls are no longer needed. Sonic MSS is the perfect way to maximize the productivity and efficiency of every professional.



- 
CENTRALIZED KEYED LOCK
- 
BALL BEARING DRAWER SLIDES
- 
DRAWER 100% RETRACTABLE
- 
304 STAINLESS STEEL WORKTOP
- 
DRAWER MAX LOAD 40 KG
- 
TOOLBOX MAX LOAD 400 KG

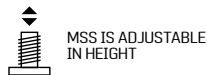

Build your own unique MSS

Compatible with Sonic Foam System



3X 1/3 190 X 370MM



1X 570 X 370MM



745 X 435MM

01



ART. NO.	DESCRIPTION
4730196	1958mm setup with wooden worktop
4731196	1958mm setup with stainless steel worktop



ART. NO.	DESCRIPTION
4730230	2300mm setup with wooden worktop
4731230	2300mm setup with stainless steel worktop



ART. NO.	DESCRIPTION
4730281	2803mm setup with wooden worktop
4731281	2803mm setup with stainless steel worktop

8 X 74MM
1 X 153MM
579 X 372MM

WIDTH 674MM
HEIGHT 962MM
DEPTH 500MM

BALL BEARING DRAWER SLIDES
DRAWER MAX LOAD 40 KG
TOOLBOX MAX LOAD 400 KG
DRAWER 100% RETRACTABLE

S S S M
1/3 190 X 370MM 1X 570 X 370MM

ART. NO.	DESCRIPTION
47280	674mm drawer cabinet 9 drawers without worktop

5 X 153MM
579 X 372MM

WIDTH 674MM
HEIGHT 962MM
DEPTH 500MM

BALL BEARING DRAWER SLIDES
DRAWER MAX LOAD 40 KG
TOOLBOX MAX LOAD 400 KG
DRAWER 100% RETRACTABLE

S S S M
1/3 190 X 370MM 1X 570 X 370MM

ART. NO.	DESCRIPTION
47647	674mm drawer cabinet 5 drawers without worktop

2 X 74MM
1 X 145MM
2 X 230MM
579 X 372MM

WIDTH 674MM
HEIGHT 962MM
DEPTH 500MM

BALL BEARING DRAWER SLIDES
DRAWER MAX LOAD 40 KG
TOOLBOX MAX LOAD 400 KG
DRAWER 100% RETRACTABLE

S S S M
1/3 190 X 370MM 1X 570 X 370MM

ART. NO.	DESCRIPTION
47640	674mm drawer cabinet 5 drawers without worktop

WIDTH 674MM
HEIGHT 962MM
DEPTH 500MM

TOOLBOX MAX LOAD 400 KG

ART. NO.	DESCRIPTION
47288	674mm storage cabinet without worktop

01



4 X 74MM

579 X 372MM

WIDTH 674MM

HEIGHT 962MM

DEPTH 500MM

BALL BEARING DRAWER SLIDES

DRAWER MAX LOAD 40 KG

TOOLBOX MAX LOAD 400 KG

DRAWER 100% RETRACTABLE

S S S M

1/3 190 X 370MM 1X 570 X 370MM

ART. NO.	DESCRIPTION
47308	674mm storage cabinet 4 drawers with door without worktop



WIDTH 674MM

HEIGHT 962MM

DEPTH 500MM

BALL BEARING DRAWER SLIDES

TOOLBOX MAX LOAD 400 KG

ART. NO.	DESCRIPTION
47431	674mm cabinet with one large recycle bin without worktop



WIDTH 674MM

HEIGHT 962MM

DEPTH 500MM

BALL BEARING DRAWER SLIDES

TOOLBOX MAX LOAD 400 KG

ART. NO.	DESCRIPTION
47450	674mm cabinet with three recycle bins without worktop



WIDTH 674MM

HEIGHT 962MM

DEPTH 500MM

ART. NO.	DESCRIPTION
47432	674mm storage cabinet with sink (tap not included)

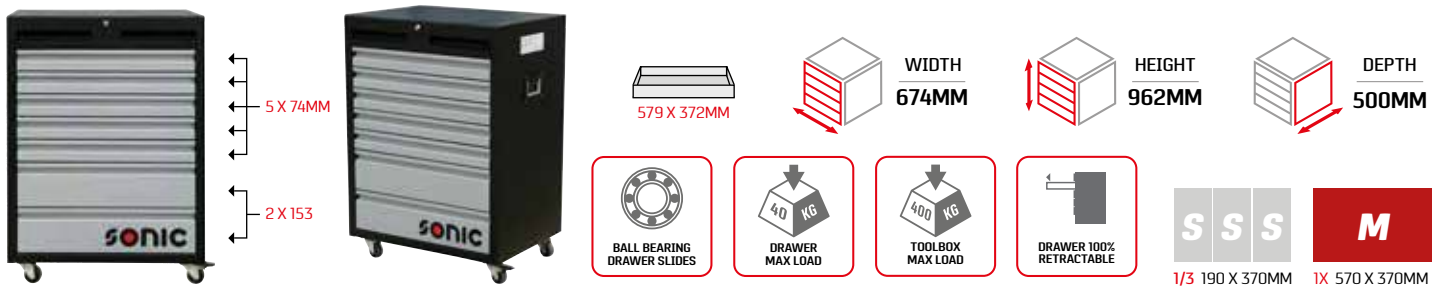

01

ART. NO.	DESCRIPTION
47451	674mm portable drawer cabinet, 7 drawers

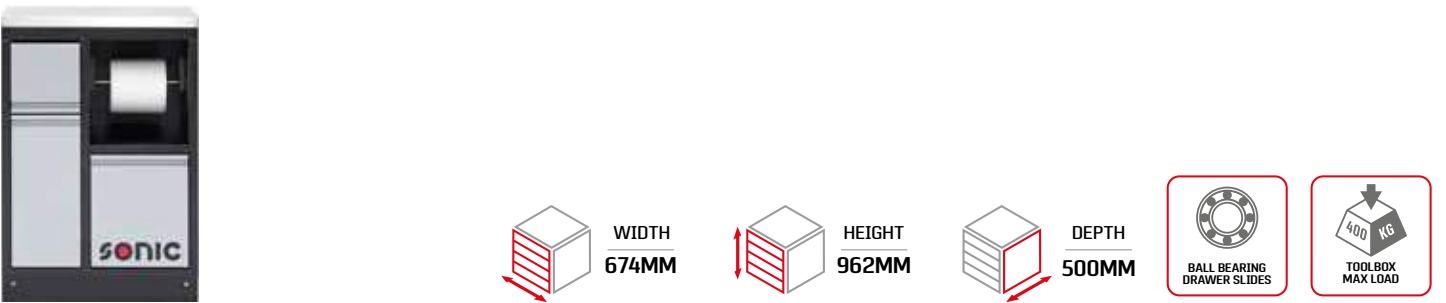

ART. NO.	DESCRIPTION
47459	674mm cabinet with recycle bin and paper roll holder without worktop

Get organized, **be efficient!**



01

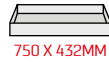
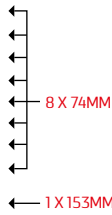

WIDTH
845MM

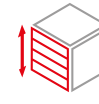

HEIGHT
962MM



DEPTH
500MM

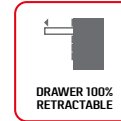

ART. NO.	DESCRIPTION
47296	845mm drawer cabinet 9 drawers without worktop

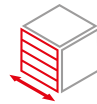

WIDTH
845MM

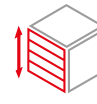

HEIGHT
962MM



DEPTH
500MM



ART. NO.	DESCRIPTION
47302	845mm storage cabinet without worktop

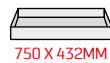
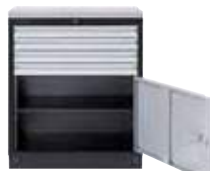
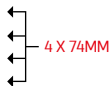

WIDTH
845MM

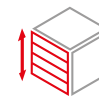

HEIGHT
962MM



DEPTH
500MM

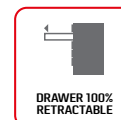

ART. NO.	DESCRIPTION
47379	845mm storage cabinet 4 drawers with right-hand door without worktop



WIDTH
845MM

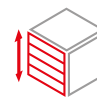

HEIGHT
962MM



DEPTH
500MM



ART. NO.	DESCRIPTION
47600	845mm reel cabinet without worktop (reels not included)

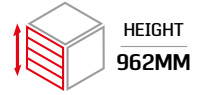
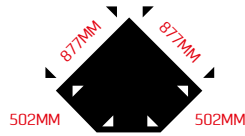

ART. NO.	DESCRIPTION
47505	845mm corner cabinet without worktop



ART. NO.	DESCRIPTION
47272	610mm tall cabinet with 5 shelves. Door is hinged on both sides. Top shelf is fixed. Other 4 shelves can be flexibly arranged.



ART. NO.	DESCRIPTION
47433	914mm tall cabinet double door with 4 shelves

01

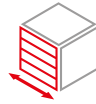

WIDTH
674MM

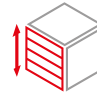

HEIGHT
400MM



DEPTH
300MM



ART. NO.	DESCRIPTION
47276	674mm wall cabinet

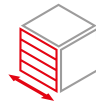

WIDTH
845MM

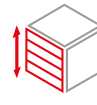

HEIGHT
400MM



DEPTH
300MM



ART. NO.	DESCRIPTION
47292	845mm wall cabinet

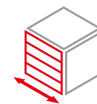

WIDTH
812MM

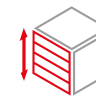

HEIGHT
400MM



ART. NO.	DESCRIPTION
47650	845mm corner wall cabinet



PRA RUBBER WOOD WOODEN WORKTOP



ART. NO.	DIMENSIONS
47378	W 674 x D 500 x H 40MM
47382	W 845 x D 500 x H 40MM
47279	W 1348 x D 500 x H 40MM
47295	W 1690 x D 500 x H 40MM
47306	W 2193 x D 500 x H 40MM

STAINLESS STEEL WORKTOP



ART. NO.	DIMENSIONS
47377	W 674 x D 500 x H 38MM
47381	W 845 x D 500 x H 38MM
47383	W 1348 x D 500 x H 38MM
47384	W 1690 x D 500 x H 38MM
47385	W 2193 x D 500 x H 38MM

STAINLESS STEEL WORKTOP EXTRA DEEP



ART. NO.	DIMENSIONS
47447	W 1348 x D 570 x H 38MM
47448	W 1690 x D 570 x H 38MM
47449	W 2193 x D 570 x H 38MM

WORKTOP FOR CORNER CABINET



ART. NO.	DESCRIPTION
47544	Pra Rubber Wood wooden worktop for corner cabinet
47545	Stainless steel worktop for corner cabinet

PERFORATED BACK PANEL

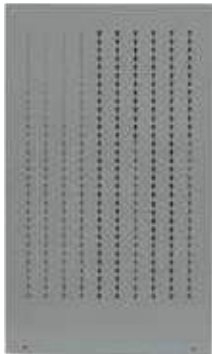

ART. NO.	DESCRIPTION
47376	674mm perforated back panel
47380	845mm perforated back panel

POSTS



ART. NO.	DIMENSIONS
47283	W 60 x D 30 x H 1910MM
47284	W 30 x D 30 x H 1910MM

LED LIGHT

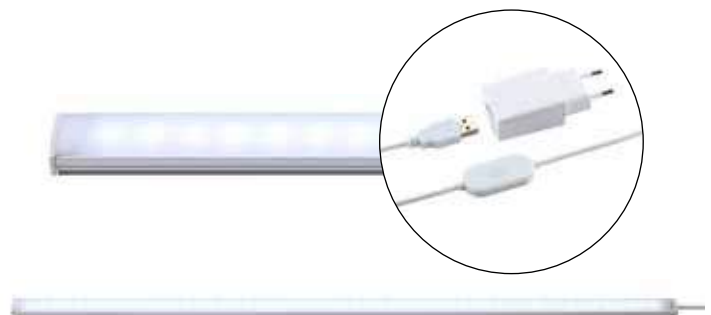

ART. NO.	DIMENSIONS
4820524	MSS LED light with dimmer

MSS HOOK

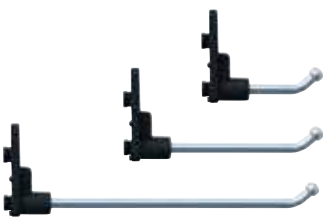

ART. NO.	DIMENSIONS
47415	MSS hook 50mml
47290	MSS hook 90mml
47291	MSS hook 150mml

MSS HOOK ROUND



ART. NO.	DIMENSIONS
47416	MSS hook round Ø40mm
47417	MSS hook round Ø60mm
47418	MSS hook round Ø80mm

MSS HOOK 90°



ART. NO.	DIMENSIONS
47419	MSS hook 90° 50mml
47420	MSS hook 90° 90mml
47421	MSS hook 90° 150mml

MSS HOOK SET

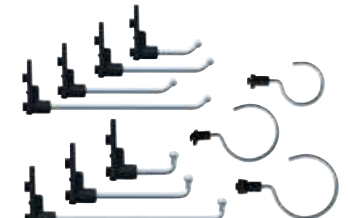

ART. NO.	DESCRIPTION
47632	MSS hook set 10-pcs

01

MSS PLIERS HOLDER		MSS SCREWDRIVER HOLDER		EMPTY TRAY, 5 COMPARTMENTS	
ART. NO.	DIMENSIONS	ART. NO.	DIMENSIONS	ART. NO.	DIMENSIONS
47638	L 280 x D 59 x H 64MM	47639	L 280 x D 38 x H 46MM	4720101	W 370 x D 145 x H 48MM <i>Also suitable for S7, S8, S9, S10 toolbox</i>

EMPTY TRAY		EMPTY TRAY		EMPTY TRAY		EMPTY TRAY, 5 COMPARTMENTS	
ART. NO.	DIMENSIONS	ART. NO.	DIMENSIONS	ART. NO.	DIMENSIONS	ART. NO.	DIMENSIONS
4720106	W 54 X D 54 X H 45MM	4720107	W 54 X D 110 X H 45MM	4720108	W 108 X D 108 X H 45MM	4720102	W 370 x D 145 x H 48MM <i>Also suitable for S7, S8, S9, S10 toolbox</i>

EMPTY TRAY		EMPTY TRAY		STORAGE CASE WITH 10 TRAYS		EMPTY TRAY, 8 COMPARTMENTS	
ART. NO.	DIMENSIONS	ART. NO.	DIMENSIONS	ART. NO.	DIMENSIONS	ART. NO.	DIMENSIONS
4720109	W 108 X D 162 X H 45MM	4720110	W 108 X D 216 X H 45MM	4720111	W 370 X D 295 X H 55MM	4720103	W 370 x D 290 x H 48MM <i>Also suitable for S7, S8, S9, S10 toolbox</i>

DISPLAY BOX 7-PCS		DISPLAY BOX 7-PCS		STORAGE CASE WITH 15 TRAYS		EMPTY TRAY, 12 COMPARTMENTS	
ART. NO.	DIMENSIONS	ART. NO.	DIMENSIONS	ART. NO.	DIMENSIONS	ART. NO.	DIMENSIONS
4720114	W 615 X D 100 X H 60MM	4720115	W 615 X D 165 X H 75MM	4720112	W 370 X D 295 X H 55MM	4720104	W 370 x D 290 x H 48MM <i>Also suitable for S7, S8, S9, S10 toolbox</i>

DISPLAY BOX 13-PCS		DISPLAY BOX 9-PCS		SAMPLE OF DRAWER FILLED WITH TRAYS		EMPTY TRAY, 18 COMPARTMENTS	
ART. NO.	DIMENSIONS	ART. NO.	DIMENSIONS	ART. NO.	DIMENSIONS	ART. NO.	DIMENSIONS
4720116	W 610 X D 165 X H 75MM	4720117	W 610 X D 240 X H 125MM	-	-	4720105	W 370 x D 290 x H 48MM <i>Also suitable for S7, S8, S9, S10 toolbox</i>

TIE-RAPS	
ART. NO.	DIMENSIONS
4821519	Tie-raps holder for MSS/MWS
4821518	Tie-raps holder for MSS/MWS; filled with cable ties*



*TIE-RAPS	
ART. NO.	CONTENTS
4821511	Tie-rap 3,6 x 140mm; 100 pieces in bag (black)
4821512	Tie-rap 3,6 x 180mm; 100 pieces in bag (black)
4821514	Tie-rap 4,8 x 220mm; 100 pieces in bag (black)
4821515	Tie-rap 4,8 x 280mm; 100 pieces in bag (black)
4821517	Tie-rap 4,8 x 370mm; 100 pieces in bag (black)

MSS LED LIGHT WITH DIMMER

01



CGO

ART. NO.	DESCRIPTION
4820524	<ul style="list-style-type: none"> - Length 600mm - 400-500 lumen - Color temperature: 6000-6500K - White light - Aluminium base + PC cover - 1.8m long cable with switch in the middle - USB connector with adaptor - Magnets for mounting on MSS included



MSS LED LIGHT



CGO

ART. NO.	DIMENSIONS
4820537	LED light, length 600mm
4820538	LED light, length 800mm
4820539	Adaptor for LED light, EU plug
4820540	Connector with switch for LED light
4820541	LED light 600mm (EU) with adaptor+connector
4820542	LED light 800mm (EU) with adaptor+connector

POWER BAR



CGO

ART. NO.	DESCRIPTION
5999302	The high performance power bars features a tough, anodized aluminium extrusion ensuring strength and durability.

POWER BAR BRACKET



ART. NO.	DESCRIPTION
5999301	<ul style="list-style-type: none"> - Angled power bar bracket can be mounted on the back panel - Angle to the bracket provides clearance for cable leads and plugs bar - The power bar bracket sits inside the backface of the post, this allows a back-to-back low level solution

SPACER



ART. NO.	DESCRIPTION
47772	Extra deep worktop through spacer



Toolbox **spare parts**

WORKTOP

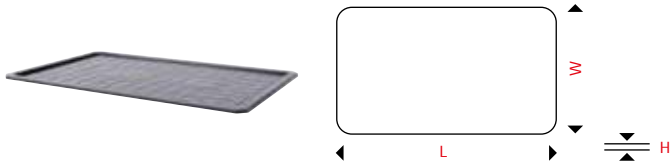

ART. NO.	DESCRIPTION	L (MM)	W (MM)	H (MM)	G	PCS/BAG
47606	Worktop	731	463	25	1360	1

Available for S7 toolbox

WORKTOP

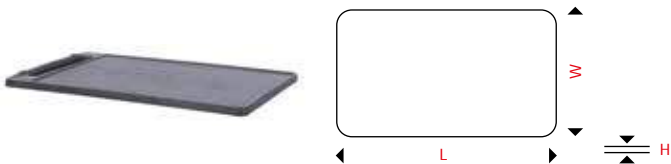

ART. NO.	DESCRIPTION	L (MM)	W (MM)	H (MM)	G	PCS/BAG
47374	Worktop	810	485	25	2700	1

Available for traditional toolbox

EVA MAT

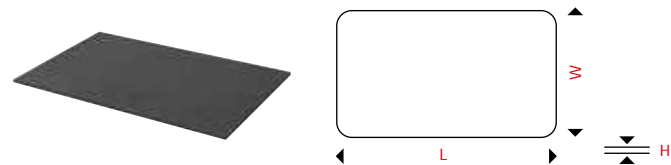

ART. NO.	DESCRIPTION	L (MM)	W (MM)	H (MM)	G	PCS/BAG
47213	Eva mat	680	450	10	130	1

Available for S8 toolbox

RUBBER MAT

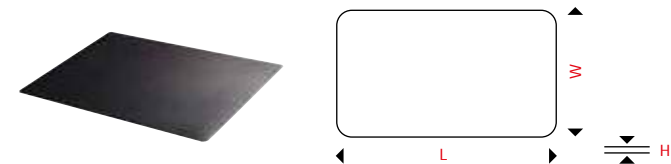

ART. NO.	DESCRIPTION	L (MM)	W (MM)	H (MM)	G	PCS/BAG
47581	Rubber mat	682	484	10	460	1

Available for S8 toolbox

RUBBER MAT

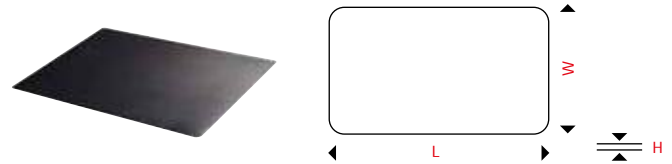

ART. NO.	DESCRIPTION	L (MM)	W (MM)	H (MM)	G	PCS/BAG
47548	S9 rubber mat	634	410	3	1320	1

47580	S12 rubber mat	805	410	3	1740	1
-------	----------------	-----	-----	---	------	---

47723	S12XD rubber mat	805	546	3	2000	1
-------	------------------	-----	-----	---	------	---

RUBBER MAT

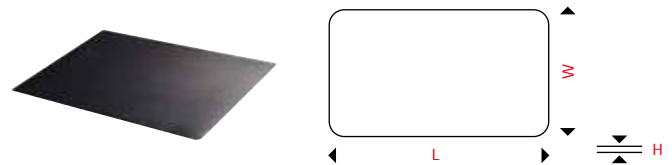

ART. NO.	DESCRIPTION	L (MM)	W (MM)	H (MM)	G	PCS/BAG
47498	S10 rubber mat	567	430	3	1200	1

47499	S11 rubber mat	737	489	3	1700	1
-------	----------------	-----	-----	---	------	---

WORKTOP



ART. NO.	DESCRIPTION	L (MM)	W (MM)	H (MM)	G	PCS/BAG
47262	S10 worktop	887	575	25	2900	1

47364	S11 worktop	1051	635	25	5000	1
-------	-------------	------	-----	----	------	---

WORKTOP

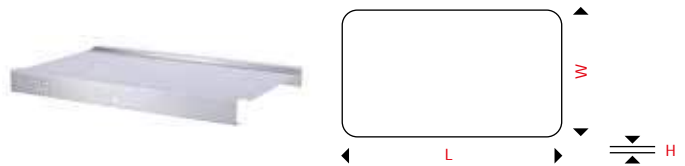

ART. NO.	DESCRIPTION	L (MM)	W (MM)	H (MM)	G	PCS/BAG
47614	S9 stainless steel worktop	640	507.5	71	5200	1

47615	S12 stainless steel worktop	811	507.5	71	7100	1
-------	-----------------------------	-----	-------	----	------	---

47751	S12XD stainless steel worktop	808	552	71	8500	1
-------	-------------------------------	-----	-----	----	------	---

WORKTOP

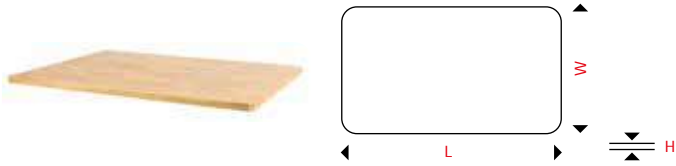

ART. NO.	DESCRIPTION	L (MM)	W (MM)	H (MM)	G	PCS/BAG
47257	Wooden worktop	1182	732	32	21970	1

Available for S13 toolbox

HANDLE

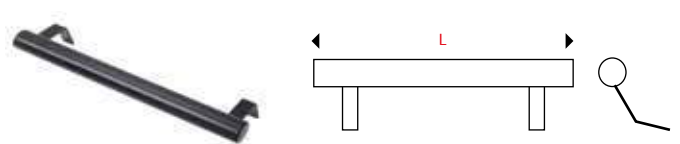

ART. NO.	DESCRIPTION	L (MM)	G	PCS/BAG
47211	Handle black	446	1000	1

Available for S8 toolbox

WORKTOP

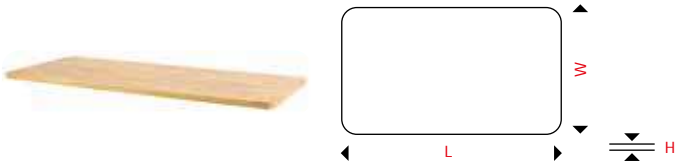

ART. NO.	DESCRIPTION	L (MM)	W (MM)	H (MM)	G	PCS/BAG
47252	Wooden worktop	1353	634	32	19500	1

Available for S14 toolbox

HANDLE

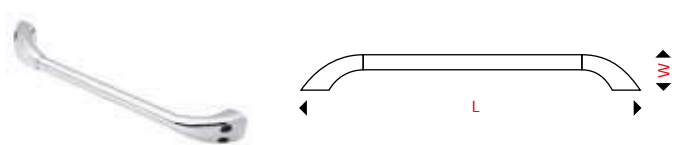

ART. NO.	DESCRIPTION	L (MM)	W (MM)	G	PCS/BAG
47251	Handle silver	572	82,2	2000	1

Available for S14 toolbox

WORKTOP

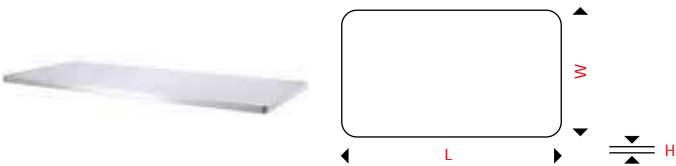

ART. NO.	DESCRIPTION	L (MM)	W (MM)	H (MM)	G	PCS/BAG
47601	Stainless steel worktop	1667	710	38	48500	1

Available for S15 toolbox

PAPER HOLDER

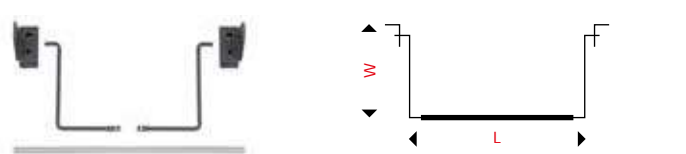

ART. NO.	DESCRIPTION	L (MM)	W (MM)	G	PCS/BAG
47230	Paper holder black	325	134	340	1

Available for S8 toolbox

PLASTIC TOP COVER

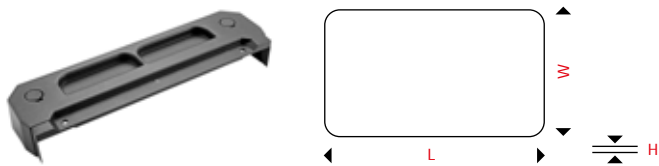

ART. NO.	DESCRIPTION	L (MM)	W (MM)	H (MM)	G	PCS/BAG
47572	S9 & S12 plastic top cover (left or right)	532	145	75	500	1
47722	S12XD plastic top cover (left or right)	668	144	75	500	1

PAPER HOLDER

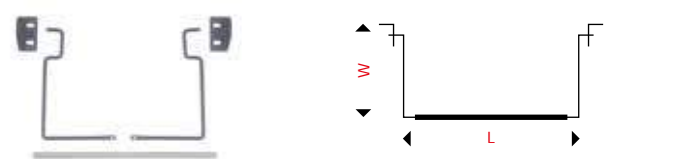

ART. NO.	DESCRIPTION	L (MM)	W (MM)	G	PCS/BAG
47522	Paper holder dark grey	279	134	320	1

Available for S9 and S12 toolbox

SUPPORT SHAFT



ART. NO.	DESCRIPTION	L (MM)	W (MM)	H (MM)	G	PCS/BAG
47551	Support shaft	80	360-435	561-761	3300	1

Available for S10 windshield toolbox

PAPER HOLDER

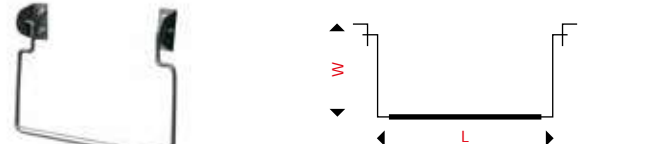

ART. NO.	DESCRIPTION	L (MM)	W (MM)	G	PCS/BAG
47549	Paper holder black	325	134	300	1

Available for S10 windshield toolbox

Empty storage solutions

PAPER HOLDER



ART. NO.	DESCRIPTION	L (MM)	W (MM)	G	PCS/BAG
47267	Paper holder black	325	134	338	1
47334	Paper holder red	325	134	338	1
47343	Paper holder blue	325	134	338	1
47369	Paper holder grey	325	134	338	1

Available for S10, S11, S14 and S15 toolbox

PAPER HOLDER



ART. NO.	DESCRIPTION	L (MM)	W (MM)	G	PCS/BAG
47644	Paper holder dark grey	325	134	300	1

Available for S12XD toolbox

UTILITY MAGNETIC TOOL HOLDER



ART. NO.	DESCRIPTION
815001	- Black coated panel - Grey rack and holder - Two magnetic pads

CAN HOLDER

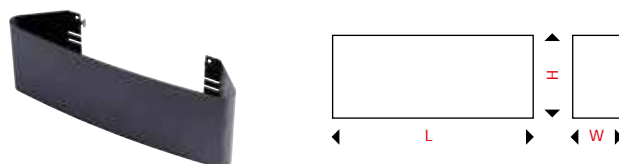

ART. NO.	DESCRIPTION	L (MM)	W (MM)	H (MM)	G	PCS/BAG
47609	Can holder black	351	95	110	500	1

Available for S7 toolbox

CAN HOLDER

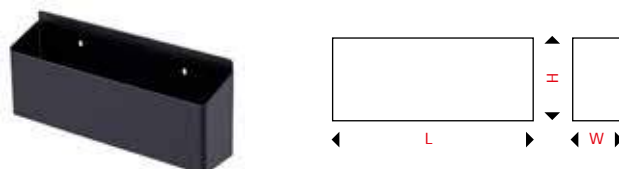

ART. NO.	DESCRIPTION	L (MM)	W (MM)	H (MM)	G	PCS/BAG
47204	Can holder black	430	90	180	1650	1

Available for S8 and S13 toolbox

CAN HOLDER

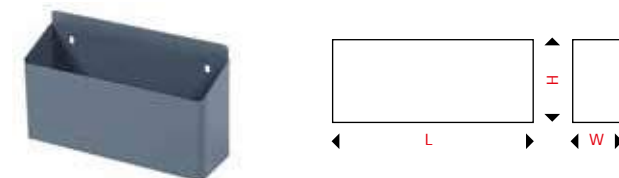

ART. NO.	DESCRIPTION	L (MM)	W (MM)	H (MM)	G	PCS/BAG
47519	Can holder dark grey	300	90	180	1150	1

Available for S9 and S12 toolbox

CAN HOLDER

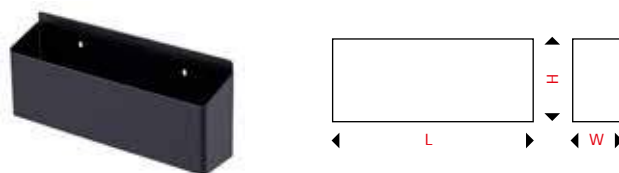

ART. NO.	DESCRIPTION	L (MM)	W (MM)	H (MM)	G	PCS/BAG
47204	Can holder black	430	90	180	1650	1
47346	Can holder red	430	90	180	1650	1
47347	Can holder blue	430	90	180	1650	1
47353	Can holder grey	430	90	180	1650	1

Available for S10 toolbox

CAN HOLDER

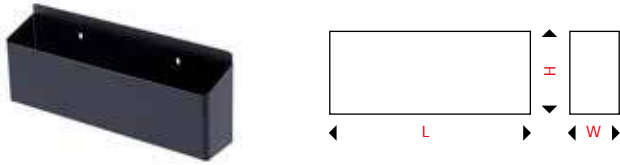

ART. NO.	DESCRIPTION	L (MM)	W (MM)	H (MM)	G	PCS/BAG
47206	Can holder black	470	90	180	1750	1
47348	Can holder red	470	90	180	1750	1
47350	Can holder blue	470	90	180	1750	1
47412	Can holder grey	470	90	180	1750	1

Available for S11 and S14 toolbox

DOCUMENT HOLDER

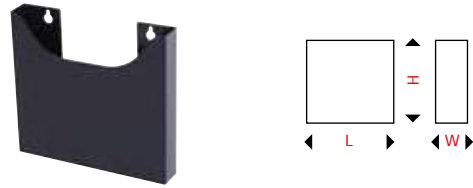

ART. NO.	DESCRIPTION	L (MM)	W (MM)	H (MM)	G	PCS/BAG
47258	Document holder black	340	55	315	1250	1
47395	Document holder red	340	55	315	1250	1
47410	Document holder blue	340	55	315	1250	1
47411	Document holder grey	340	55	315	1250	1

Available for S8, S10, S11 and S14 toolbox

CAN HOLDER

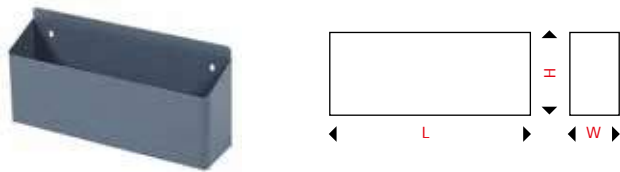

ART. NO.	DESCRIPTION	L (MM)	W (MM)	H (MM)	G	PCS/BAG
47643	Can holder dark grey	430	90	180	1650	1

Available for S12XD toolbox

TRASH CAN

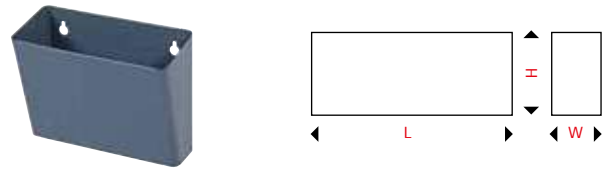

ART. NO.	DESCRIPTION	L (MM)	W (MM)	H (MM)	G	PCS/BAG
47520	Trash can dark grey	310	130	241	1400	1

Available for S9 and S12 toolbox

CAN HOLDER

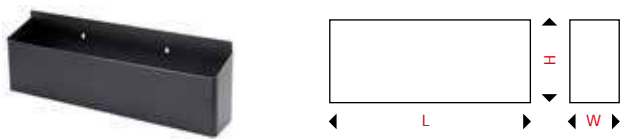

ART. NO.	DESCRIPTION	L (MM)	W (MM)	H (MM)	G	PCS/BAG
47605	Can holder black	550	90	180	2050	1

Available for S15 toolbox

TRASH CAN

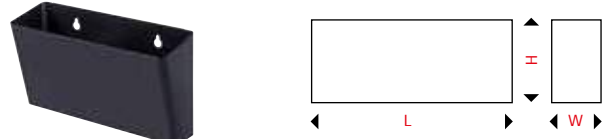

ART. NO.	DESCRIPTION	L (MM)	W (MM)	H (MM)	G	PCS/BAG
47259	Trash can black	430	130	241	1850	1
47273	Trash can red	430	130	241	1850	1
47322	Trash can blue	430	130	241	1850	1
47368	Trash can grey	430	130	241	1850	1

Available for S8, S10, S11, S13 and S14 toolbox

DOCUMENT HOLDER

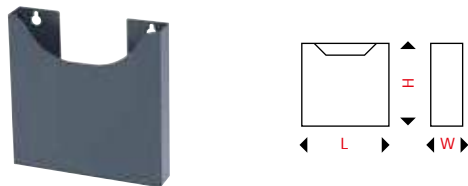

ART. NO.	DESCRIPTION	L (MM)	W (MM)	H (MM)	G	PCS/BAG
47521	Document holder dark grey	340	55	315	1250	1

Available for S9 and S12 toolbox

SIDE TABLE



ART. NO.	DESCRIPTION	L (MM)	W (MM)	H (MM)	G	PCS/BAG
47264	Side table 454 x 302 MM	460	300	230	4400	1

Available for S8 and S13 toolbox

Empty storage solutions

CASTER SET

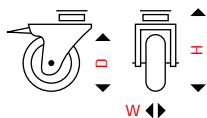

ART. NO.	DESCRIPTION	D (MM)	W (MM)	H (MM)	G	PCS/BAG
47209	4-pcs caster set	125	50	180	4880	1
47209F	Fixed caster	125	50	180	1200	1
47209S	Swivel caster	125	50	180	1240	1

Available for S8, S9, S10, S11 and S12 toolbox

CASTER SET

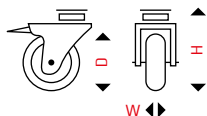

ART. NO.	DESCRIPTION	D (MM)	W (MM)	H (MM)	G	PCS/BAG
47631	4-pcs caster set	150	51	195	9400	1
47631F	Fixed caster	150	51	195	2100	1
47631S	Swivel caster	150	51	195	2600	1

Available for S12XD, S13, S14 and S15 toolbox

CASTER SET

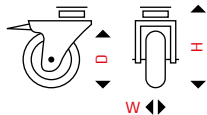

ART. NO.	DESCRIPTION	D (MM)	W (MM)	H (MM)	G	PCS/BAG
47494	4-pcs caster set	62	23	86	1240	1
47494S	Caster	62	23	86	290	1
47494B	Caster with brake	62	23	86	330	1

Available for MSS toolbox 47451

CASTER SET AND HANDLE

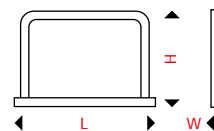
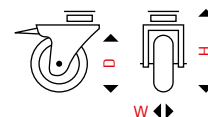

ART. NO.	DESCRIPTION	D (MM)	W (MM)	D (MM)	H (MM)	G	PCS/BAG
47561	4-pcs caster set	125	50	125	180	4880	1
	Handle	430	46	-	324	1350	1

Available for S9 topbox trolley

CASTER SET

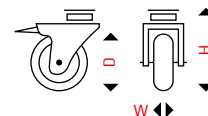

ART. NO.	DESCRIPTION	D (MM)	W (MM)	H (MM)	G	PCS/BAG
47573	4-pcs caster set	100	35	137	2900	1
47573F	Fixed caster	100	35	137	540	1
47573S	Swivel caster	100	35	137	910	1

Available for S7 and service cart

DRAWER RAILS



ART. NO.	DESCRIPTION	PCS/BAG
47666	Left drawer rail	1
47667	Right drawer rail	1

Available for S7 toolbox

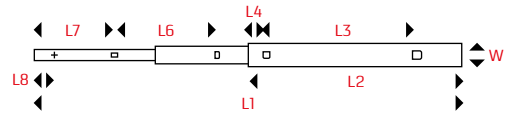
DRAWER RAILS

ART. NO.	DESCRIPTION	L1(MM)	L2(MM)	L3(MM)	L4(MM)	L5(MM)	L6(MM)	L7(MM)	L8(MM)	W(MM)	G	PCS/BAG
47215	Left drawer rail	800	400	290	19	400	178	144	24	45	584	1
47216	Right drawer rail	800	400	290	19	400	178	144	24	45	584	1

Available for S8, S9, S10, S13 toolbox and MSS

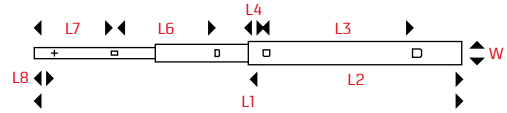
DRAWER RAILS

ART. NO.	DESCRIPTION	L1(MM)	L2(MM)	L3(MM)	L4(MM)	L5(MM)	L6(MM)	L7(MM)	L8(MM)	W(MM)	G	PCS/BAG
47328	Right drawer rail with plastic knob	800	400	290	19	400	178	144	24	45	572	1

Available for S8, S9, S10, S13 toolbox and MSS

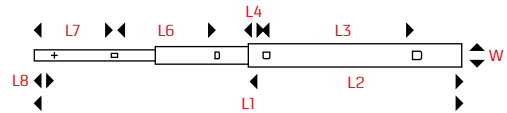
DRAWER RAILS

ART. NO.	DESCRIPTION	L1(MM)	L2(MM)	L3(MM)	L4(MM)	L5(MM)	L6(MM)	L7(MM)	L8(MM)	W(MM)	G	PCS/BAG
47671	Left drawer rail	870	435	290	19	435	178	144	24	45	644	1
47672	Right drawer rail	870	435	290	19	435	178	144	24	45	644	1

Available for service cart, S11, S12 toolbox, MSS and SWS

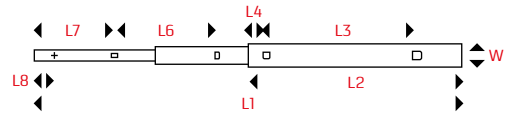
DRAWER RAILS

ART. NO.	DESCRIPTION	L1(MM)	L2(MM)	L3(MM)	L4(MM)	L5(MM)	L6(MM)	L7(MM)	L8(MM)	W(MM)	G	PCS/BAG
47329	Right drawer rail with plastic knob	870	435	290	19	435	178	144	24	45	626	1

Available for S11, S12 toolbox MSS and SWS

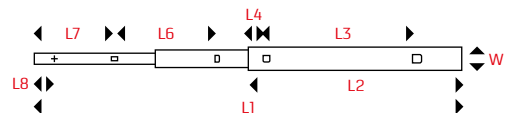
DRAWER RAILS

ART. NO.	DESCRIPTION	L1(MM)	L2(MM)	L3(MM)	L4(MM)	L5(MM)	L6(MM)	L7(MM)	L8(MM)	W(MM)	G	PCS/BAG
47243	Left drawer rail	1154	577	290	19	577	178	144	24	45.7	852	1
47244	Right drawer rail	1154	577	290	19	577	178	144	24	45.7	852	1

Available for S12XD, S14 and S15 toolbox

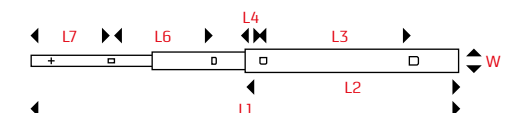
DRAWER RAILS

ART. NO.	DESCRIPTION	L1(MM)	L2(MM)	L3(MM)	L4(MM)	L5(MM)	L6(MM)	L7(MM)	W(MM)	G	PCS/BAG
47733	Left drawer rail	422	200	147.5	6.5	197	144.5	32.5	35	210	1
47734	Right drawer rail	422	200	147.5	6.5	197	144.5	32.5	35	210	1

Available for service topbox

Empty storage solutions

DRAWERS



ART. NO.	DESCRIPTION	L (MM)	W (MM)	H (MM)	G	PCS/BAG
47607	Shallow drawer	580	385	73	2100	1
47608	Deep drawer without logo	580	385	152	3200	1
47610	Deep drawer with logo	580	385	152	3200	1

Available for S7 toolbox

DRAWERS



ART. NO.	DESCRIPTION	L (MM)	W (MM)	H (MM)	G	PCS/BAG
47253	Shallow drawer	579	381	74	3300	1
47254	Deep drawer with logo	579	381	153	4300	1
47396	Deep drawer without logo	579	381	153	4300	1

Available for S8 toolbox

DRAWERS



ART. NO.	DESCRIPTION	L (MM)	W (MM)	H (MM)	G	PCS/BAG
47517	Shallow drawer	579	372	74	3300	1
47518	Deep drawer with logo	579	372	153	4900	1
47686	Deep drawer without logo	579	372	153	4900	1

Available for S9 toolbox

DRAWERS



ART. NO.	DESCRIPTION	L (MM)	W (MM)	H (MM)	G	PCS/BAG
47265	Shallow drawer, black	579	379	74	3200	1
47266	Deep drawer with logo, black	579	379	153	4200	1
47687	Deep drawer without logo, black	579	379	153	4200	1
47318	Shallow drawer, red	579	379	74	3200	1
47319	Deep drawer with logo, red	579	379	153	4200	1
47688	Deep drawer without logo, red	579	379	153	4200	1
47320	Shallow drawer, blue	579	379	74	3200	1
47321	Deep drawer with logo, blue	579	379	153	4200	1
47689	Deep drawer without logo, blue	579	379	153	4200	1
47391	Shallow drawer, grey	579	379	74	3200	1
47392	Deep drawer with logo, grey	579	379	153	4200	1
47690	Deep drawer without logo, grey	579	379	153	4200	1

Available for S10 toolbox

DRAWERS



ART. NO.	DESCRIPTION	L (MM)	W (MM)	H (MM)	G	PCS/BAG
47550	Deep drawer with logo	579	379	232	5300	1
47553	Deep drawer without logo	579	379	153	4300	1

Available for S10 windshield toolbox

DRAWERS

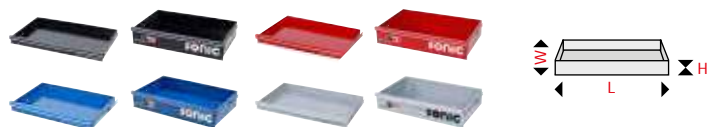

ART. NO.	DESCRIPTION	L (MM)	W (MM)	H (MM)	G	PCS/BAG
47365	Shallow drawer, black	750	433	74	4200	1
47366	Deep drawer with logo, black	750	433	153	5600	1
47691	Deep drawer without logo, black	750	433	153	5600	1
47337	Shallow drawer, red	750	433	74	4200	1
47338	Deep drawer with logo, red	750	433	153	5600	1
47692	Deep drawer without logo, red	750	433	153	5600	1
47339	Shallow drawer, blue	750	433	74	4200	1
47340	Deep drawer with logo, blue	750	433	153	5600	1
47693	Deep drawer without logo, blue	750	433	153	5600	1
47393	Shallow drawer, grey	750	433	74	4200	1
47394	Deep drawer with logo, grey	750	433	153	5600	1
47694	Deep drawer without logo, grey	750	433	153	5600	1

Available for S11 toolbox

DRAWERS

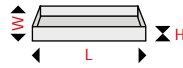

ART. NO.	DESCRIPTION	L (MM)	W (MM)	H (MM)	G	PCS/BAG
47546	Shallow drawer	750	432	74	4400	1
47547	Deep drawer with logo	750	432	153	6100	1
47695	Deep drawer without logo	750	432	153	6100	1

Available for S12 toolbox

DRAWERS

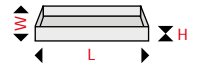

ART. NO.	DESCRIPTION	L (MM)	W (MM)	H (MM)	G	PCS/BAG
47602	Top drawer	1413	575	196	13000	1
47603	Shallow drawer	579	573	74	3700	1
47604	Deep drawer with logo	579	573	153	5500	1
47515	Shallow drawer	750	573	74	5000	1

Available for S15 toolbox

DRAWERS

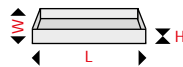
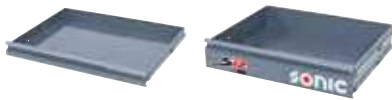

ART. NO.	DESCRIPTION	L (MM)	W (MM)	H (MM)	G	PCS/BAG
47645	Small drawer	752	580	74	5500	1
47646	Deep drawer with logo	752	580	153	7700	1
47750	Deep drawer without logo	752	580	153	7700	1

Available for S12XD toolbox

DRAWERS

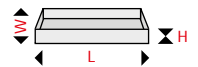

ART. NO.	DESCRIPTION	L (MM)	W (MM)	H (MM)	G	PCS/BAG
47637	Shallow drawer	496	202	53	1100	1

Available for service topbox

DRAWERS



ART. NO.	DESCRIPTION	L (MM)	W (MM)	H (MM)	G	PCS/BAG
47265	Shallow drawer	579	379	74	3200	1
47266	Deep drawer with logo	579	379	153	4200	1
47523	Small drawer	147	379	83.5	1300	1

Available for S13 toolbox

METAL KNOB



ART. NO.	DESCRIPTION	L (MM)	W (MM)	H (MM)	G	PCS/BAG
47630	Metal knob for shelves lockers	20	16	-	3	1

Available for MSS

DRAWERS



ART. NO.	DESCRIPTION	L (MM)	W (MM)	H (MM)	G	PCS/BAG
47513	Shallow drawer	377	579	74	3200	1
47514	Deep drawer	377	579	153	4600	1
47515	Shallow drawer	750	579	74	5000	1
47516	Deep drawer	750	579	153	7000	1

Available for S14 toolbox

DRAWERS



ART. NO.	DESCRIPTION	L (MM)	W (MM)	H (MM)	G	PCS/BAG
47281	Shallow drawer for MSS 674mm	579	372	74	3200	1
47282	Deep drawer with logo for MSS 674mm	579	372	153	4600	1
47491	Deep drawer without logo for MSS 674mm	579	372	153	4600	1
47641	Extra deep drawer without logo for MSS 674mm	579	372	232	6300	1
47642	Extra deep drawer with logo for MSS 674mm	579	372	232	6300	1
47297	Shallow drawer for MSS 845mm	750	432	74	4500	1
47298	Deep drawer with logo for MSS 845mm	750	432	153	6300	1
47414	Deep drawer without logo for MSS 845mm	750	432	153	6300	1

Available for MSS

Empty storage solutions

01

DRAWER



ART. NO.	DESCRIPTION	L (MM)	W (MM)	H (MM)	G	PCS/BAG
47452	Bin drawer	604	432	785	9500	1

Available for MSS 47450

DRAWERS



ART. NO.	DESCRIPTION	L (MM)	W (MM)	H (MM)	G	PCS/BAG
47464	Shallow drawer for SWS 47457 (black)	579	427	310	7600	1
47478	Shallow drawer for SWS 47471 (red)	579	427	310	7600	1
47465	Deep drawer with logo for SWS 47457 (black)	579	427	390	8400	1
47479	Deep drawer with logo for SWS 47471 (red)	579	427	390	8400	1

Available for SWS

DRAWERS

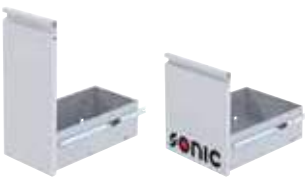

ART. NO.	DESCRIPTION	L (MM)	W (MM)	H (MM)	G	PCS/BAG
47477	High drawer	211	440	530	3700	1
47651	Low drawer	307	440	390	3900	1

Available for MSS 47649

DRAWERS



ART. NO.	DESCRIPTION	L (MM)	W (MM)	H (MM)	G	PCS/BAG
47462	Lower drawer for SWS 47456 (black)	307	471	310	6200	1
47476	Lower drawer for SWS 47470 (red)	307	471	310	6200	1

Available for SWS

DRAWERS

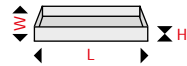

ART. NO.	DESCRIPTION	L (MM)	W (MM)	H (MM)	G	PCS/BAG
47439	Bin drawer	604	432	530	8200	1

Available for MSS 47431

DRAWERS

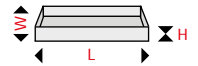

ART. NO.	DESCRIPTION	L (MM)	W (MM)	H (MM)	G	PCS/BAG
47461	Deep drawer for SWS 47456 (black)	211	471	705	6500	1
47475	Deep drawer for SWS 47470 (red)	211	471	705	6500	1

Available for SWS

DRAWERS



ART. NO.	DESCRIPTION	L (MM)	W (MM)	H (MM)	G	PCS/BAG
47466	Shallow drawer for SWS 47458 (black)	579	381	74	4200	1
47480	Shallow drawer for SWS 47472 (red)	579	381	74	4200	1
47467	Deep drawer for SWS 47458 (black)	579	381	153	5300	1
47481	Deep drawer for SWS 47472 (red)	579	381	153	5300	1
47468	Deep drawer with logo for SWS 47458 (black)	579	381	153	5300	1
47482	Deep drawer with logo for SWS 47472 (red)	579	381	153	5300	1

Available for MSS

RECYCLE BIN



ART. NO.	DESCRIPTION	L (MM)	W (MM)	H (MM)	G	PCS/BAG
47652	Recycle bin	280	400	465	2000	1

Available for MSS 47431

RECYCLE BIN



ART. NO.	DESCRIPTION	L (MM)	W (MM)	H (MM)	G	PCS/BAG
47453	Big recycle bin for	280	400	650	2850	1

Available for MSS 47450

SHELF



ART. NO.	DESCRIPTION	L (MM)	W (MM)	H (MM)	G	PCS/BAG
47460	Shelf for SWS 47455 (black)	615	450	25	2844	1
47474	Shelf for SWS 47469 (red)	615	450	25	2844	1

Available for SWS

RECYCLE BINS

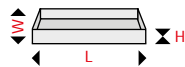

ART. NO.	DESCRIPTION	L (MM)	W (MM)	H (MM)	G	PCS/BAG
47463	Recycle bin	190	430	400	1800	1

Available for SWS

KEY AND LOCK



ART. NO.	DESCRIPTION	G	PCS/BAG
47622	Key for toolbox (2016)	14	2
47623	Masterkey for toolbox (2016)	14	1
47624	Key with lock (toolbox/MSS/MWS 180° - 2016)	60	2
47625	Key with lock (topbox/toolbox 90° - 2016)	60	1

Available for S8, S9, S10, S11, S13, S14 toolbox, MSS and SWS

SKIRTING BOARD



ART. NO.	DESCRIPTION	L (MM)	W (MM)	H (MM)	G	PCS/BAG
47275	Front skirting board for MSS 47272	610	88	12	460	1
47289	Front skirting board for MSS 674mm	674	88	12	540	1
47303	Front skirting board for MSS 845mm	845	88	12	660	1
47541	Front skirting board for MSS 47505	565	88	12	440	1
47310	Side skirting board for MSS 47272	507	88	12	380	1
47389	Side skirting board for MSS 674mm and 845mm	477	88	12	380	1

Available for MSS

KEY AND LOCK



ART. NO.	DESCRIPTION	G	PCS/BAG
47210	Key	14	2
47214	Key with lock	60	1

Available for S7, S8, S9, S10, S11, S12, S13, S14, S15 toolbox, MSS and SWS

SHELF



ART. NO.	DESCRIPTION	L (MM)	W (MM)	H (MM)	G	PCS/BAG
47367	Shelf for MSS locker (47272)	538	490	25	2700	1
47434	Shelf for MSS locker (47433)	847	495	25	4150	1
47287	Shelf for MSS locker 674mm	615	450	25	2800	1
47301	Shelf for MSS locker 845mm	785	450	25	3500	1
47543	Shelf for MSS closet (47505)	616	430	25	3400	1

Available for MSS

KEY AND LOCK



ART. NO.	DESCRIPTION	G	PCS/BAG
47386	Key	14	2

Available for traditional and Jumbo toolbox, traditional and Jumbo topbox

CHOOSE THE TOOLS THAT SUIT YOU

Sonic offers filled storage solutions for every level of expertise. We classify our range based on four labels that indicate the recommended level of expertise: Basic, Intermediate, Advanced and Expert.

B

BASIC

The Basic badge classifies a complete solution for starting technicians

I

INTERMEDIATE

The Intermediate badge classifies a complete solution for skilled technicians

A

ADVANCED

The Advanced badge classifies an advanced solution for seasoned technicians

E

EXPERT

The Expert badge classifies an extensive solution for the most experienced technicians, who are up for any challenge



**WORK
EFFICIENT
WORK
WITH SONIC**



**FILLED
STORAGE
SOLUTIONS**

Your complete mobile workspace.

02 > Filled storage solutions



> S7 toolbox
PAGE 67



> S13 toolbox
PAGE 94-95



> S8 toolbox
PAGE 68



> S14 toolbox
PAGE 87-92, 97



> S9 toolbox
PAGE 70-83, 111



> S15 toolbox
PAGE 88, 90-92, 97



> S9 VAS toolbox
PAGE 100



> Topboxes
PAGE 103



> S10 toolbox
PAGE 71-83



> Cases
PAGE 104-105



> S11 toolbox
PAGE 84-89



> Tool bag
PAGE 106



> S12 toolbox
PAGE 84-89, 112

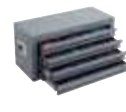

> Service topbox
PAGE 108



> S12 XD toolbox
PAGE 90-93



> Portable toolbox
PAGE 109



> S12 VAS toolbox
PAGE 101



S7 toolbox



02

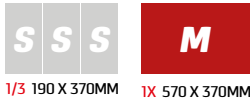

Art. no. 713840

S7 toolbox 6 drawers. 3 drawers filled with **138-PCS** tools



Art. no. 714040

S7 toolbox 6 drawers. 3 drawers filled with **140-PCS** tools



S8 toolbox



1X 570 X 370MM



B BASIC

Art. no. 720606 S8 toolbox 7 drawers. 3 drawers filled with **206-PCS** tools.

1 602904



2 316001

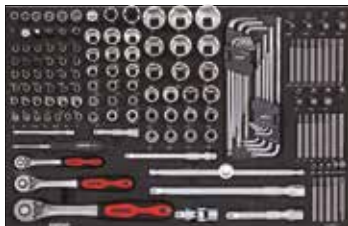

3 601707



B BASIC

Art. no. 724006 S8 toolbox 7 drawers. 4 drawers filled with **241-PCS** tools.

1 602407

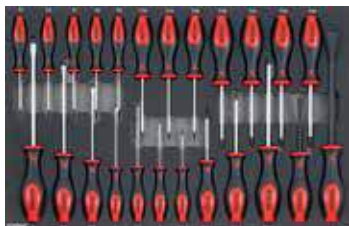

2 316001



3 604002



4 601707



B BASIC

Art. no. 728406 S8 toolbox 7 drawers. 4 drawers filled with **285-PCS** tools.

1 112102



2 310101



3 604002



4 602302



S8 toolbox



1/3 190 X 370MM

**SPECIALLY DESIGNED
FOR MOTORCYCLES**



02

Art. no. 725306

S8 toolbox 7 drawers. 5 drawers filled with 253-PCS tools.

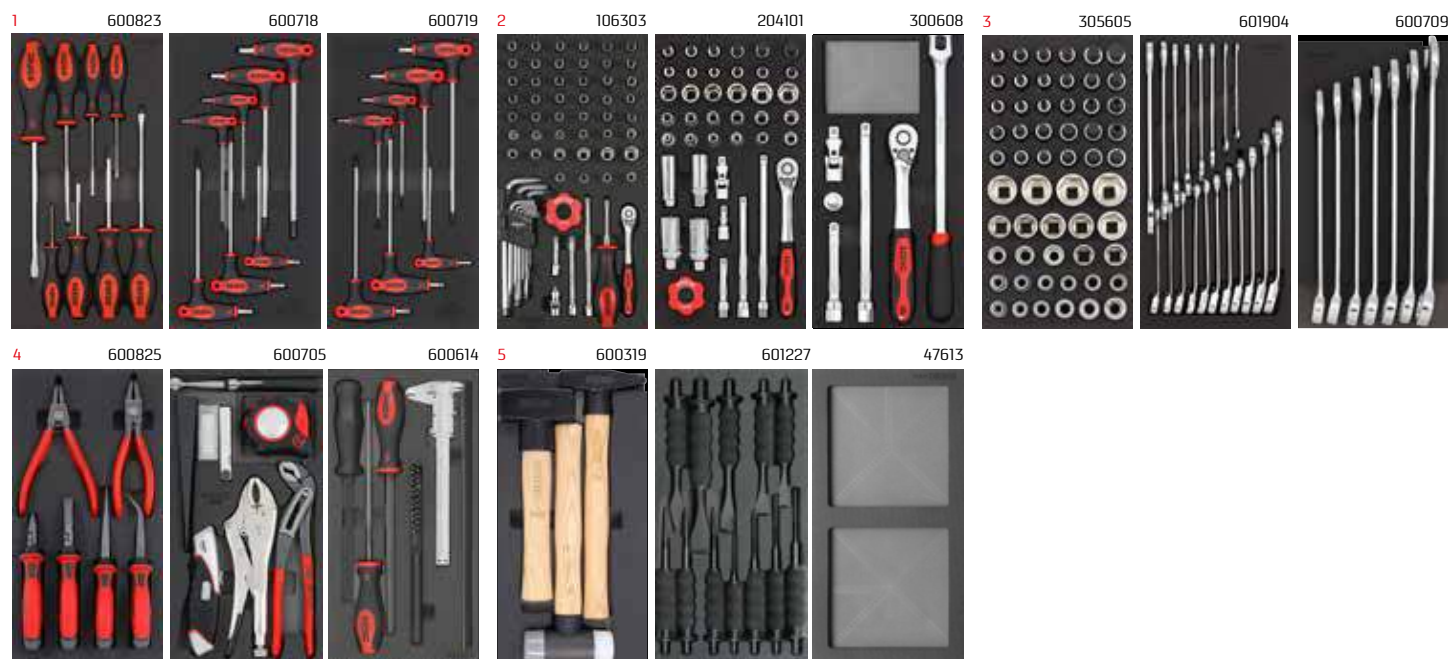

S9 toolbox

M

1X 570 X 370MM



Art. no. 717331

S9 toolbox 8 drawers.
4 drawers filled with **173-PCS** tools.

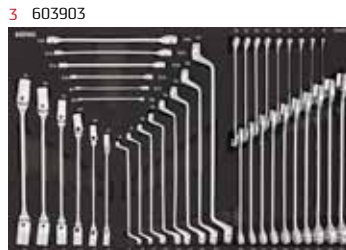
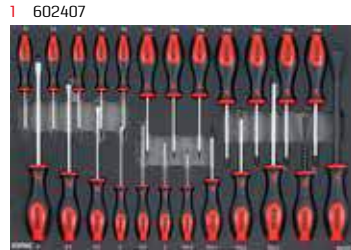

Art. no. 723931

S9 toolbox 8 drawers.
5 drawers filled with **239-PCS** tools.

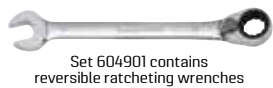
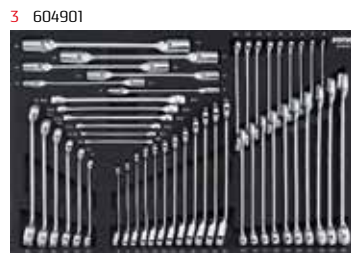
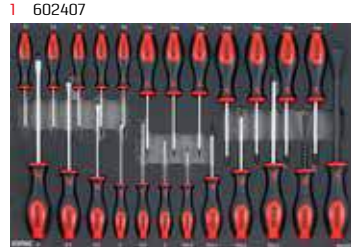

Art. no. 726131

S9 toolbox 8 drawers.
6 drawers filled with **261-PCS** tools.

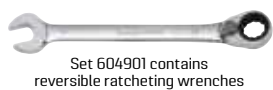
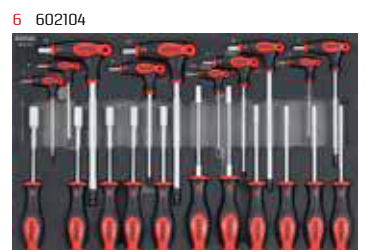
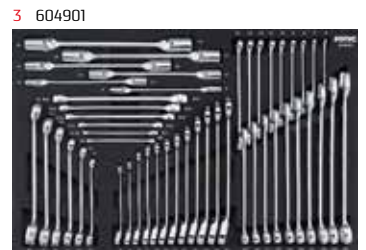
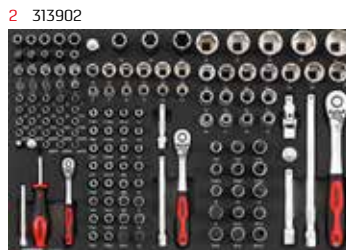
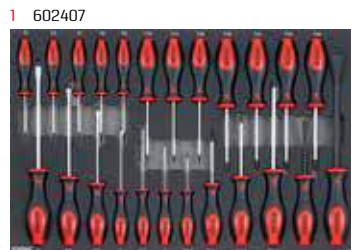



S9 and S10 toolbox

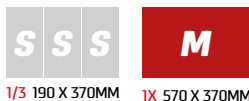

1/3 190 X 370MM 1X 570 X 370MM



02



1 INTERMEDIATE



1 INTERMEDIATE

1 602407

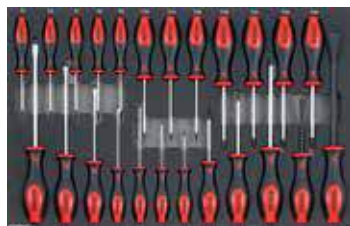

2 316001



3 604002



4 601707



5 602104



- Art. no. 726231 [S9]
- Art. no. 726209 [S10]
- Art. no. 726215 [S10]
- Art. no. 726216 [S10]
- Art. no. 726219 [S10]

S9 and S10 toolbox 8 drawers.
5 drawers filled with 262-PCS tools.



1 INTERMEDIATE



1 INTERMEDIATE

1 600823 600824 106303

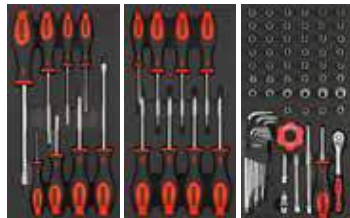

2 204101 300908 303805



3 601903 601225 601016

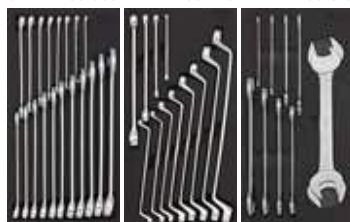

4 600319 601227 600614



5 600825 600705 600717

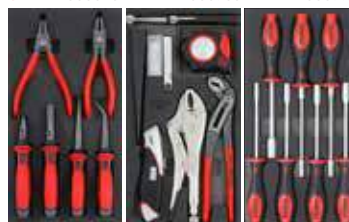

- Art. no. 725131 [S9]
- Art. no. 725109 [S10]
- Art. no. 725115 [S10]
- Art. no. 725116 [S10]
- Art. no. 725119 [S10]

S9 and S10 toolbox 8 drawers.
5 drawers filled with 251-PCS tools.



1 INTERMEDIATE



1 INTERMEDIATE

1 602407

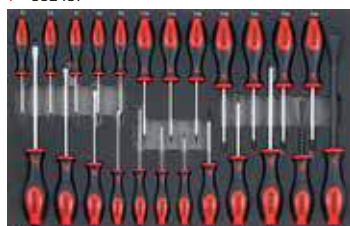

2 313902



3 604002

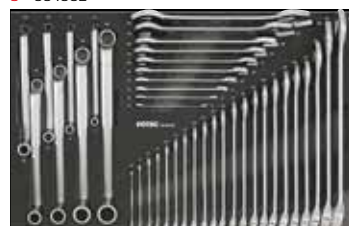

4 603003



5 602302



6 602104



- Art. no. 727731 [S9]
- Art. no. 727709 [S10]
- Art. no. 727715 [S10]
- Art. no. 727716 [S10]
- Art. no. 727719 [S10]

S9 and S10 toolbox 8 drawers.
6 drawers filled with 277-PCS tools.



I INTERMEDIATE



I INTERMEDIATE

S9 and S10 toolbox



1/3 190 X 370MM



- Art. no. 730231 [S9]
- Art. no. 730209 [S10]
- Art. no. 730215 [S10]
- Art. no. 730216 [S10]
- Art. no. 730219 [S10]

S9 and S10 toolbox 8 drawers. 6 drawers filled with 302-PCS tools.



S9 **TOOLS** 339 PCS

I INTERMEDIATE

S10 **TOOLS** 339 PCS

I INTERMEDIATE

S9 and S10 toolbox

S S S

1/3 190 X 370MM



02

- Art. no. 733831 [S9]
- Art. no. 733809 [S10]
- Art. no. 733815 [S10]
- Art. no. 733816 [S10]
- Art. no. 733819 [S10]



Set 601904 contains reversible ratcheting wrenches

S9 and S10 toolbox 8 drawers. 7 drawers filled with 339-PCS tools.

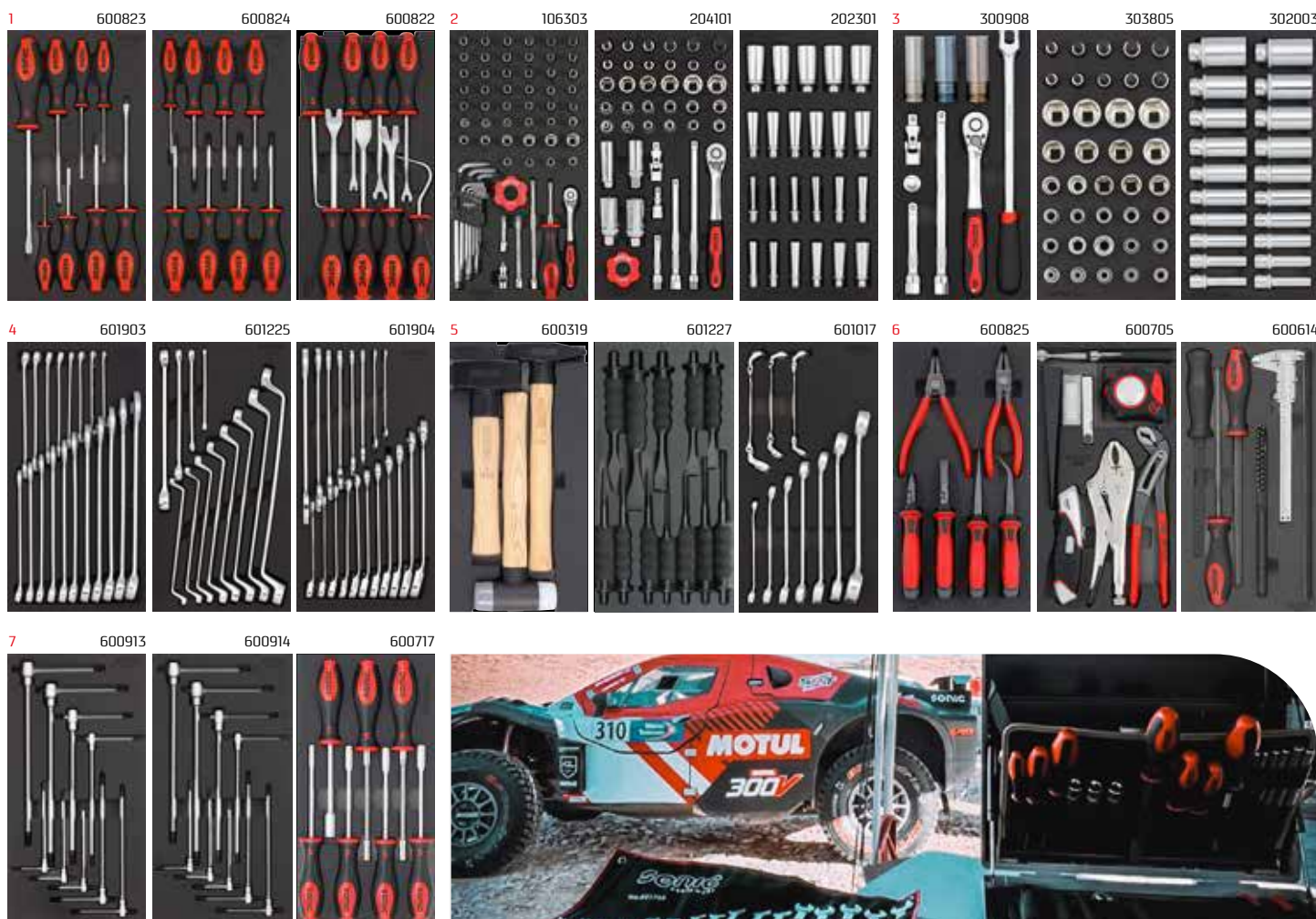



I INTERMEDIATE



I INTERMEDIATE

S9 and S10 toolbox



1X 570 X 370MM



- Art. no. 736931 [S9]
- Art. no. 736909 [S10]
- Art. no. 736915 [S10]
- Art. no. 736916 [S10]
- Art. no. 736919 [S10]



Set 603003 contains reversible ratcheting wrenches

S9 and S10 toolbox 8 drawers. 6 drawers filled with 369-PCS tools.

<p>1 602407</p>	<p>2 215702</p>	<p>3 309502</p>
<p>4 604002</p>	<p>5 603003</p>	<p>6 602302</p>



S9 ETOOLS 349 PLUS

A ADVANCED

S9 toolbox

M

1X 570 X 370MM

SPECIALLY DESIGNED FOR MOTORCYCLES



02

Art. no. 734931

S9 toolbox 8 drawers. 7 drawers filled with **349-PCS** tools.

1 602716

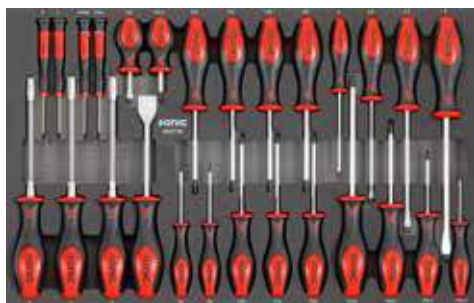

2 214301



3 305002



4 605304



5 604207



6 601606



7 601806

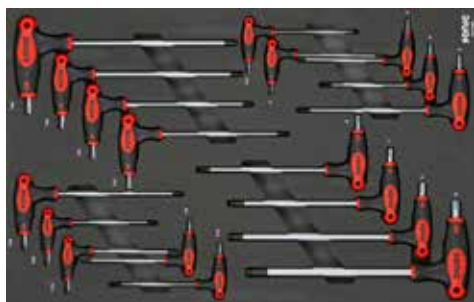

Filled storage solutions



I INTERMEDIATE



I INTERMEDIATE

S9 and S10 toolbox

02

M

1X 570 X 370MM



- Art. no. 739131 [S9]
- Art. no. 739009 [S10]
- Art. no. 739015 [S10]
- Art. no. 739016 [S10]
- Art. no. 739119 [S10]



Set 604702 contains reversible ratcheting wrenches

S9 and S10 toolbox 8 drawers. 7 drawers filled with 391-PCS tools.

1 602407

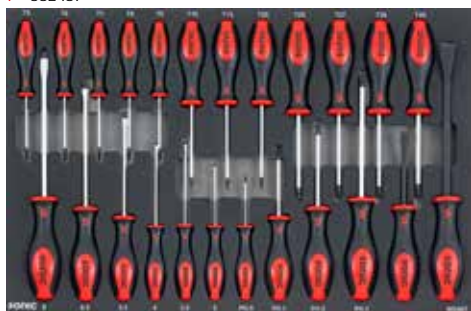

2 215702



3 309502



4 604002



5 604702



6 601207



7 601601



S9 + TOOLS 420 PCS

A ADVANCED

S10 + TOOLS 420 PCS

A ADVANCED

S9 and S10 toolbox

M

1X 570 X 370MM



02

- Art. no. 742031 (S9)
- Art. no. 742009 (S10)
- Art. no. 742015 (S10)
- Art. no. 742016 (S10)
- Art. no. 742019 (S10)



Set 604901 contains reversible ratcheting wrenches

S9 and S10 toolbox 8 drawers. 6 drawers filled with **420-PCS** tools.

1 602407

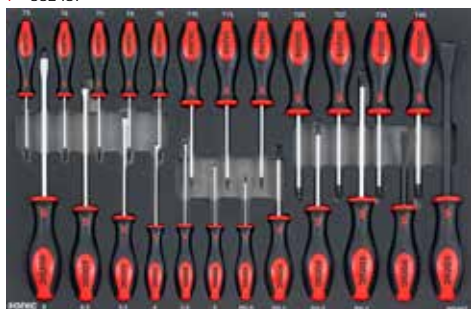

2 215702



3 309502



4 307302



5 604901



6 602209



Filled storage solutions



S10 toolbox



- Art. no. 746009
- Art. no. 746015
- Art. no. 746016
- Art. no. 746019

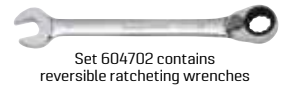

S10 toolbox 8 drawers. 8 drawers filled with 460-PCS tools.

1 112102



2 310101



3 603002

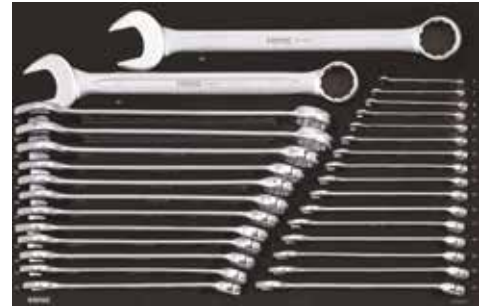

4 604702



5 307302



6 403201



7 403301



8 602302



S9 and S10 toolbox



1/3 190 X 370MM



02

- Art. no. 747131 (S9)
- Art. no. 747109 (S10)
- Art. no. 747115 (S10)
- Art. no. 747116 (S10)
- Art. no. 747119 (S10)



Set 601904 contains reversible ratcheting wrenches

S9 and S10 toolbox 8 drawers. 7 drawers filled with 471-PCS tools.

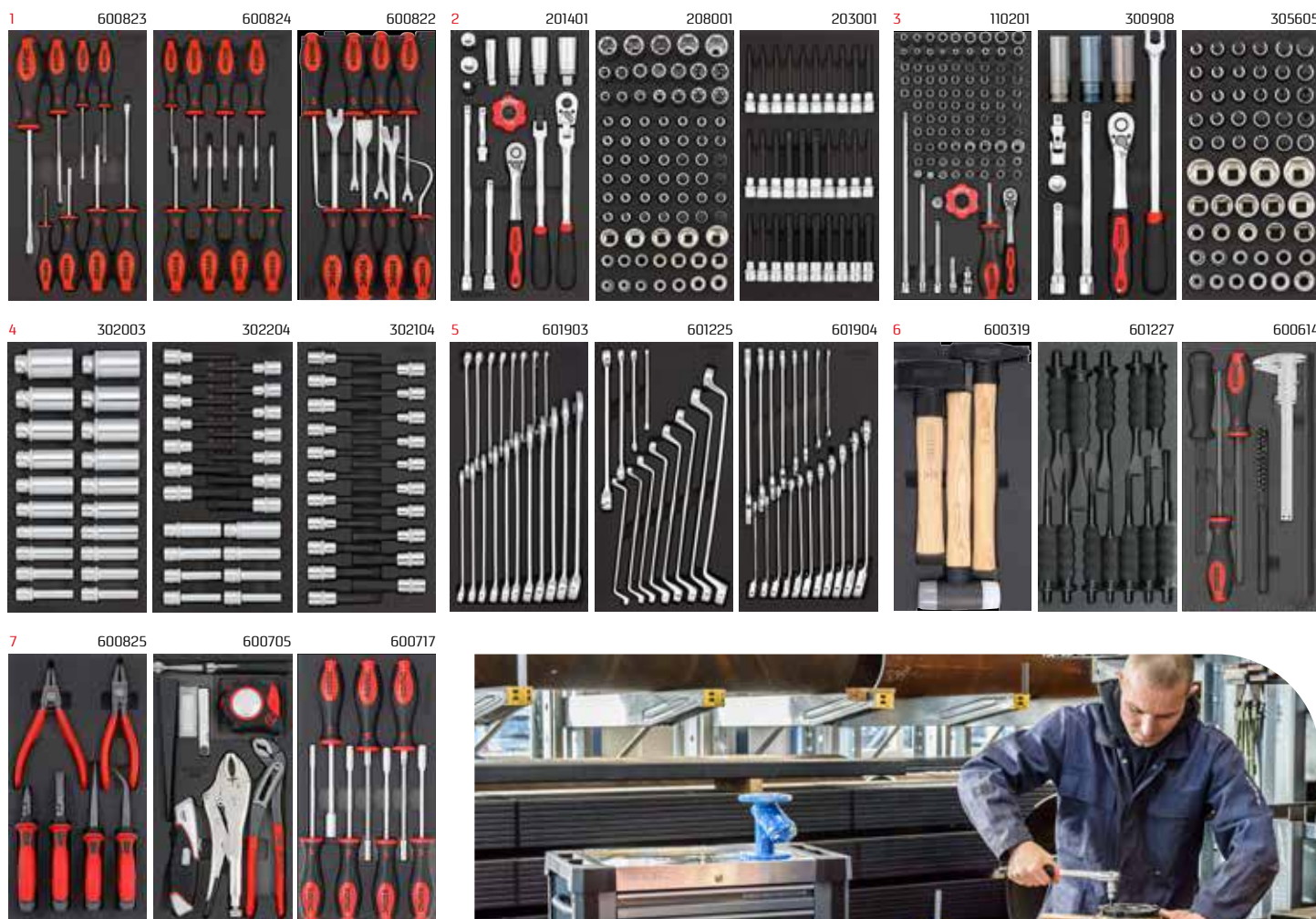



S9 and S10 toolbox



- Art. no. 752731 (S9)
- Art. no. 752709 (S10)
- Art. no. 752715 (S10)
- Art. no. 752716 (S10)
- Art. no. 752719 (S10)

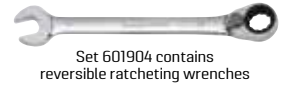

S9 and S10 toolbox 8 drawers. 8 drawers filled with 527-PCS tools.

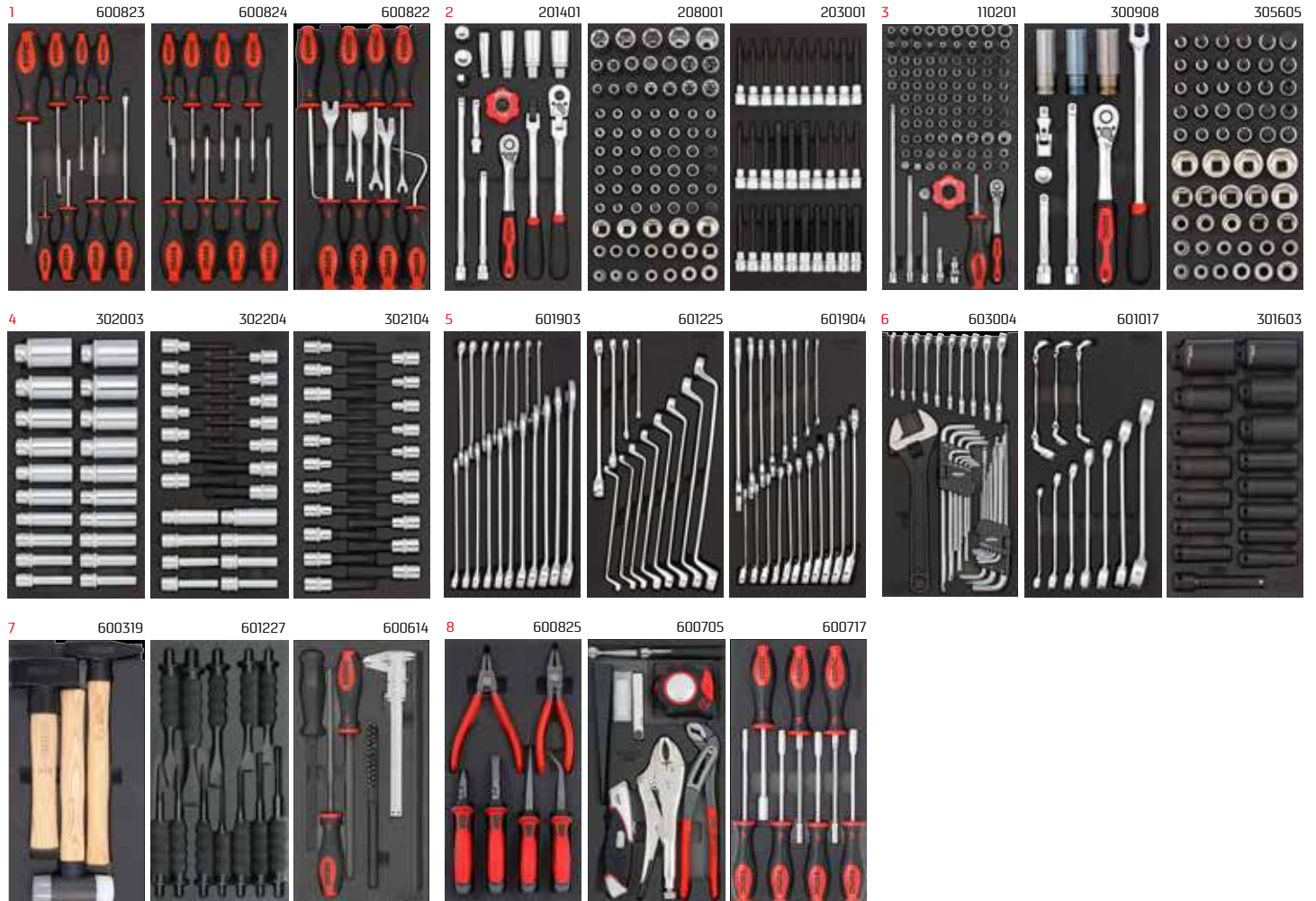



A ADVANCED



A ADVANCED

S9 and S10 toolbox



1/3 190 X 370MM



02

- Art. no. 753931 [S9]
- Art. no. 753909 [S10]
- Art. no. 753915 [S10]
- Art. no. 753916 [S10]
- Art. no. 753919 [S10]



Set 601904 contains reversible ratcheting wrenches

S9 and S10 toolbox 8 drawers. 8 drawers filled with 539-PCS tools.

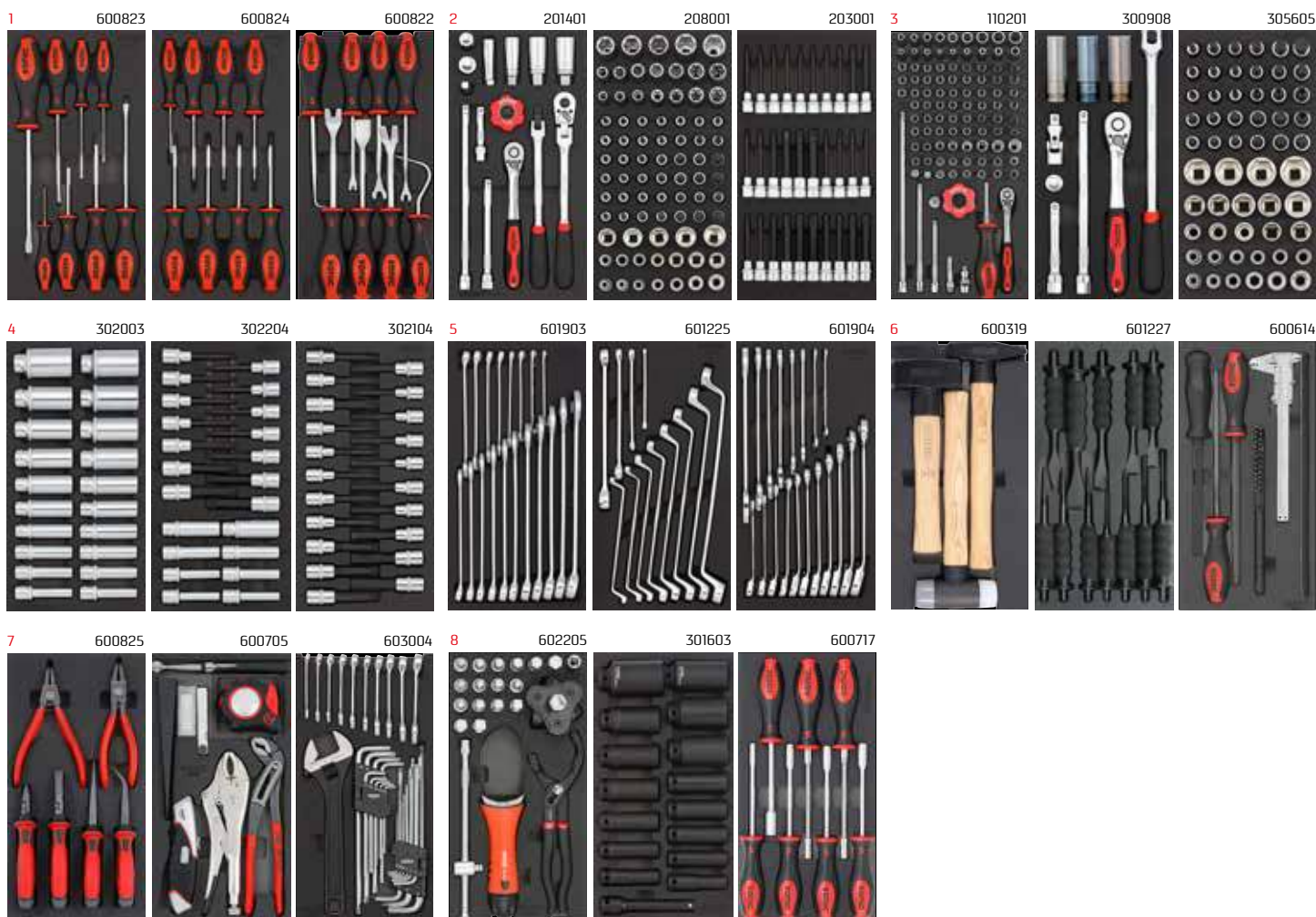

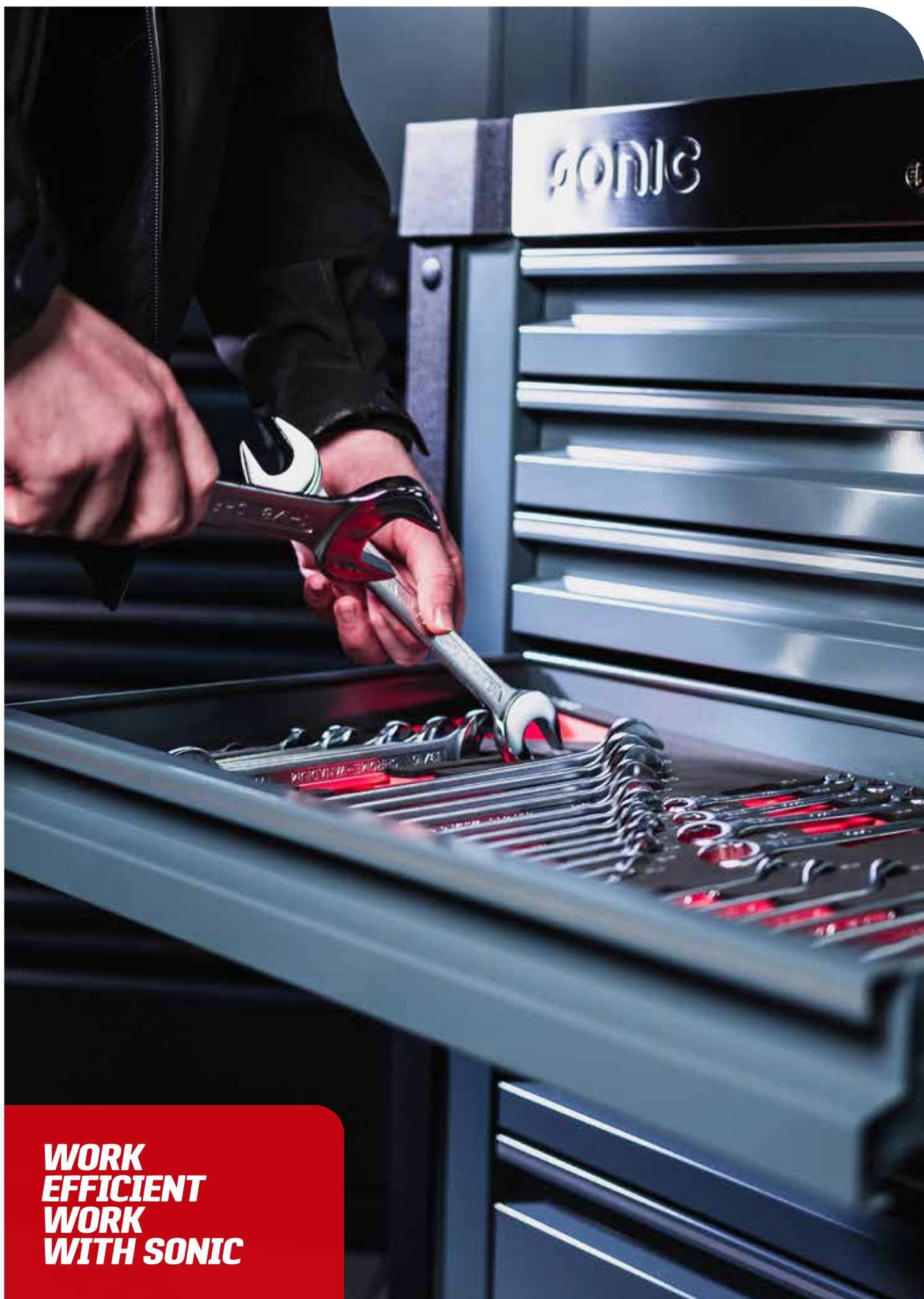

**WORK
EFFICIENT
WORK
WITH SONIC**



S9 and S10 toolbox



IX 570 X 370MM



02



B BASIC



B BASIC

- Art. no. 716931 [S9]
- Art. no. 717109 [S10]
- Art. no. 717115 [S10]
- Art. no. 717116 [S10]
- Art. no. 717119 [S10]

S9 and S10 toolbox 8 drawers.
4 drawers filled with **171-PCS** tools.

Drawers 2 + 3 SAE set

1 602407

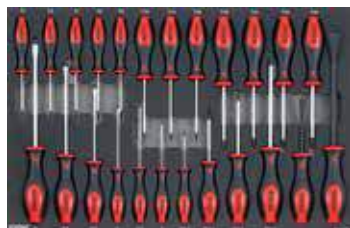

2 309301



3 603101



4 602302



I INTERMEDIATE



I INTERMEDIATE

- Art. no. 735231 [S9]
- Art. no. 735709 [S10]
- Art. no. 735715 [S10]
- Art. no. 735716 [S10]
- Art. no. 735719 [S10]

S9 and S10 toolbox 8 drawers.
6 drawers filled with **357-PCS** tools.

Drawers 5 + 6 SAE set

1 602407

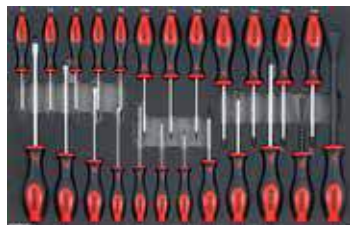

2 313902



3 604002



4 602302



5 310001



6 603101



S11

S12

S11 and S12 toolbox

02



1X 745 X 435MM



S12 TOOLS 263 PCS

I INTERMEDIATE

Art. no. 726329 [S12]

S12 toolbox 8 drawers.
4 drawers filled with 263-PCS tools.

1 603202

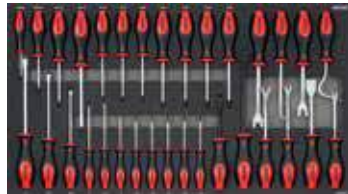

Set 605301 contains reversible ratcheting wrenches

2 315601



3 605301



4 602204



S11 TOOLS 345 PCS

I INTERMEDIATE

S12 TOOLS 345 PCS

I INTERMEDIATE

- Art. no. 734511 [S11]
- Art. no. 734517 [S11]
- Art. no. 734518 [S11]
- Art. no. 734520 [S11]
- Art. no. 734529 [S12]

S11 and S12 toolbox 8 drawers.
6 drawers filled with 345-PCS tools.

1 603202

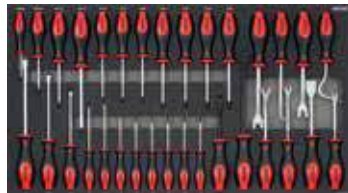

2 315601



3 605301



4 602204



5 604202



6 604001





S11 and S12 toolbox



02



1X 745 X 435MM



- Art. no. 740011 [S11]
- Art. no. 740017 [S11]
- Art. no. 740018 [S11]
- Art. no. 740020 [S11]
- Art. no. 740029 [S12]



Set 605101 contains reversible ratcheting wrenches

S11 and S12 toolbox 8 drawers. 6 drawers filled with **400-PCS** tools.

1 603207

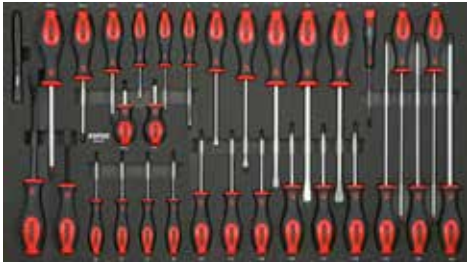

2 218502



3 308201



4 605101



5 602308



6 602710

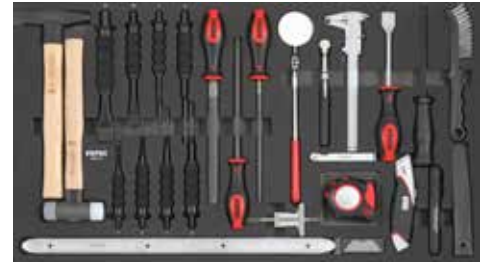

Toolboxes for the universal workshop, specialized in maintenance and repair for **Volkswagen, Audi, Seat and Skoda.**



S11 and S12 toolbox

02

L
1X 745 X 435MM



- Art. no. 748512 [S11]
- Art. no. 748517 [S11]
- Art. no. 748518 [S11]
- Art. no. 748520 [S11]
- Art. no. 748529 [S12]



Set 605301 contains reversible ratcheting wrenches

S11 and S12 toolbox 8 drawers. 7 drawers filled with **485-PCS** tools.

1 603202

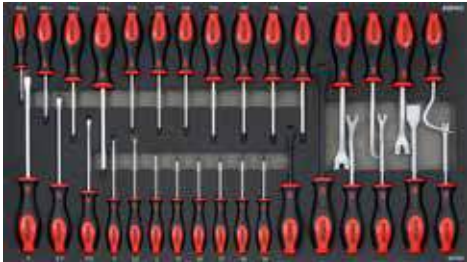

2 221201



3 308401



4 605301



5 602204



6 604202



7 604001





S11, S12 and S14 toolbox



1X 745 X 435MM



02

- Art. no. 753311 (S11) Art. no. 753329 (S12)
- Art. no. 753317 (S11) Art. no. 753308 (S14)
- Art. no. 753318 (S11)
- Art. no. 753320 (S11)



Set 605301 contains reversible ratcheting wrenches

The S14 is equipped with deeper drawers. The inlay will be complemented by a spacer to fill up the drawer.

S11 and S12 toolbox 8 drawers. S14 toolbox 8 drawers. 8 drawers filled with **533-PCS** tools.

1 603202

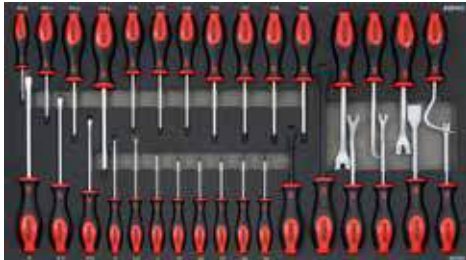

2 221201



3 308401



4 605301



5 604801

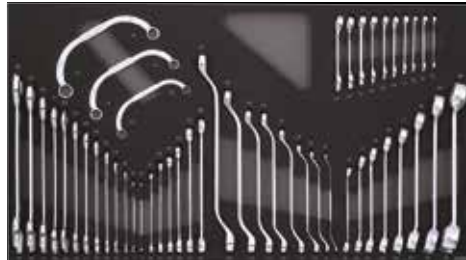

6 602204



7 604202



8 604001





S11, S12, S14 and S15 toolbox



1X 745 X 435MM



- Art. no. 757511 [S11] Art. no. 757529 [S12]
- Art. no. 757517 [S11] Art. no. 757508 [S14]
- Art. no. 757518 [S11] Art. no. 757544 [S15]
- Art. no. 757520 [S11]



Set 605301 contains reversible ratcheting wrenches

The S14 and S15 are equipped with deeper drawers. The inlay will be complemented by a spacer to fill up the drawer.

S11, S12, S14 and S15 toolbox 7 drawers filled with 575-PCS tools

1 114602

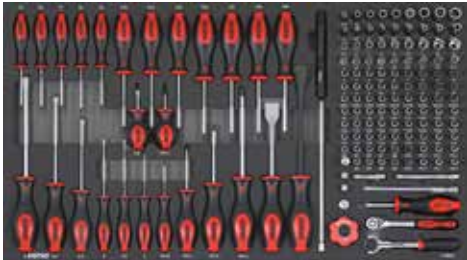

2 216401



3 311801



4 605301



5 602605



6 602803



7 604001



S11, S12 and S14 toolbox

02

L

1X 745 X 435MM



- Art. no. 764411 [S11] Art. no. 764429 [S12]
- Art. no. 764417 [S11] Art. no. 764408 [S14]
- Art. no. 764418 [S11]
- Art. no. 764420 [S11]



Set 605301 contains reversible ratcheting wrenches

The S14 and S15 are equipped with deeper drawers. The inlay will be complemented by a spacer to fill up the drawer.

S11, S12 and S14 toolbox 8 drawers filled with **644-PCS** tools

<p>1 114602</p>	<p>2 216401</p>	<p>3 311801</p>
<p>4 605301</p>	<p>5 606901</p>	<p>6 602605</p>
<p>7 602803</p>	<p>8 604001</p>	

Filled storage solutions



S12XD, S14 and S15 toolbox

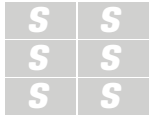

6X 1/3 190 X 370MM



Art. no. 760546 [S12XD]
 Art. no. 760508 [S14]
 Art. no. 760544 [S15]



Set 601904 contains reversible ratcheting wrenches

S12XD, S14 and S15 toolbox 5 drawers filled with 600-PCS tools

1

600719	600718
600822	600717
600823	600824

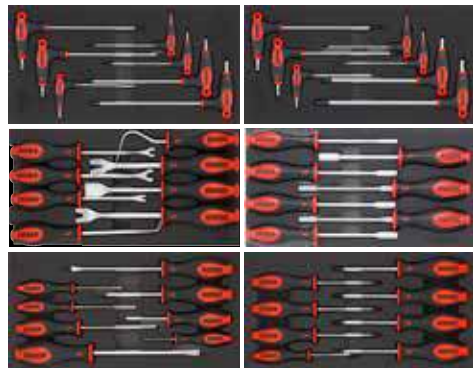

2

603004	202301
203001	208001
110201	201401

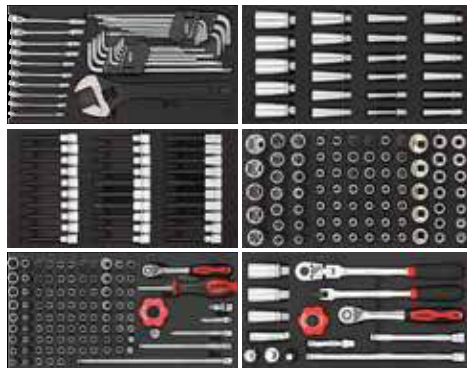

3

301603	302104
302003	302204
305605	300908



4

601225	600708
600709	601017
601903	601904

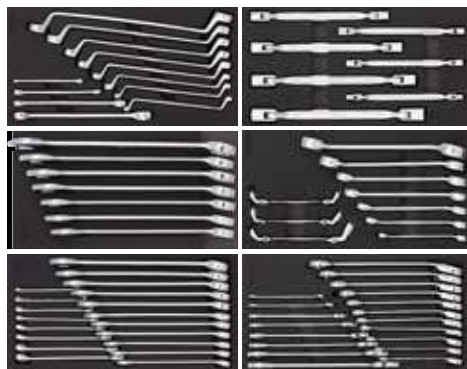

5

600614	602205
601227	600705
600319	600825



S12 XD +TOOLS 714 PCS
E EXTREME

S14 +TOOLS 714 PCS
E EXTREME

S15 +TOOLS 714 PCS
E EXTREME

S12XD, S14 and S15 toolbox

XL

1X 745 X 570MM



02

Art. no. 771446 [S12XD]
 Art. no. 771408 [S14]
 Art. no. 771444 [S15]

S12XD toolbox 7 drawers filled with **714-PCS** tools

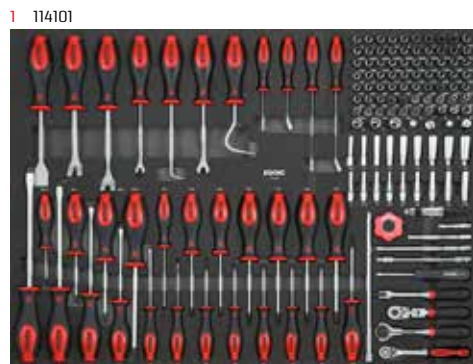

XD
EXTRA DEEP

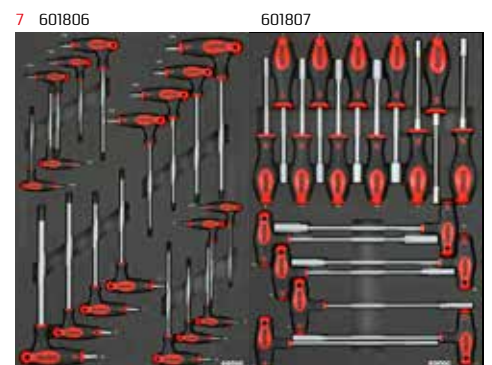
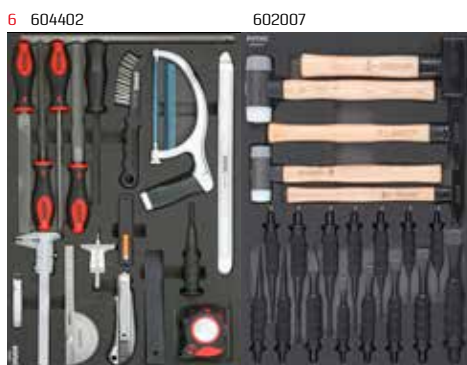
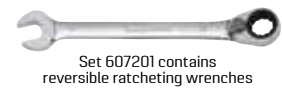



S12XD, S14 and S15 toolbox



1X 745 X 570MM



Art. no. 773546 [S12XD]
 Art. no. 773508 [S14]
 Art. no. 773544 [S15]

S12XD toolbox 7 drawers filled with 735-PCS tools

1 114101

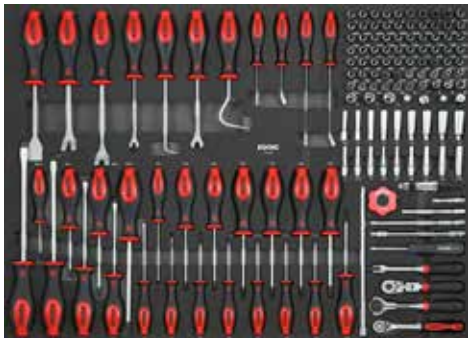

2 221801



3 314901



4 607201

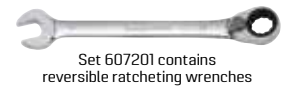

5 603402



6 604402



602007

7 601806



303902



S12XD toolbox



1X 745 X 570MM



02

Art. no. 772346

S12XD toolbox 7 drawers filled with **723-PCS** tools

1 114101

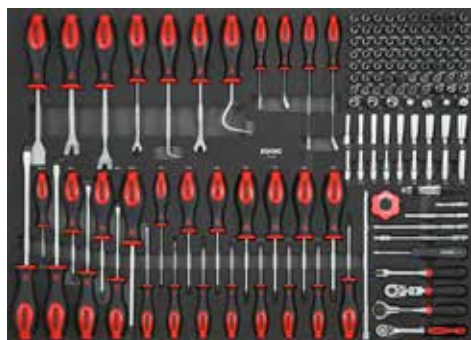

2 221803



HEAVY DUTY

3 311501



4 606601

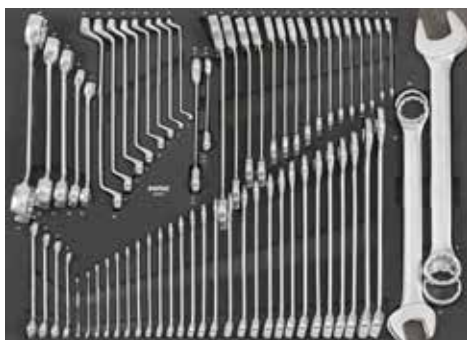

5 606302



6 603209



7 601909



306901

Filled storage solutions

S13 TOOLS 290 PCS

I INTERMEDIATE

S13 toolbox

M

1X 570 X 370MM



Art. no. 728907

S13 toolbox 5 drawers filled with **290-pcs** tools

1 112102



2 310101



3 604002



4 601601



5 601207





S13 toolbox

HEAVY DUTY

M
1X 570 X 370MM



02

Art. no. 754007

S13 toolbox 11 drawers filled with **540-PCS** tools

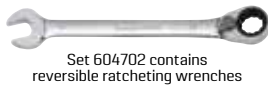

Set 604702 contains reversible ratcheting wrenches

1 602407

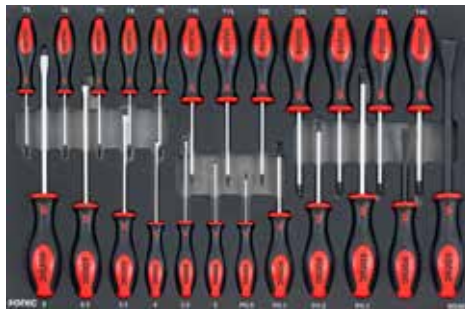

2 215702



3 309502



4 603002



5 604702



6 601207



7 601601



8 307302



9 403301



10 403201



11 602104





**WORK
EFFICIENT
WORK
WITH SONIC**



S14 and S15 toolbox

02

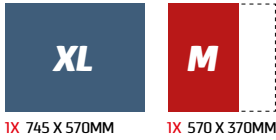

Art. no. 795808 [S14] Art. no. 795844 [S15]

**The S15 is equipped with deeper drawers. The inlay will be complemented by a spacer to fill up the drawer.*

S14 and S15 toolbox 12 drawers filled with **958-PCS** tools

<p>1L 604501</p>	<p>1R 601808 47612*</p>	<p>2L 221801</p>	<p>2R 116901 47612*</p>	
<p>3L 314901</p>	<p>3R 306402 47612*</p>	<p>4L 607201</p>	<p>4R 605001 47612*</p>	
<p>5L 604402 602007</p>	<p>5R 303902 47612*</p>	<p>6L 603402</p>		
<p>7L 601806 601807</p>		<p>Set 607201 contains reversible ratcheting wrenches</p>	<p>Set 314901 contains impact socket set 1/2", 3-pcs</p>	<p>Set 221801 contains torque wrench 732210100, 20-100Nm Set 314901 contains torque wrench 732380400, 80-400Nm</p>



**WORK
EFFICIENT
WORK
WITH SONIC**





Volkswagen chooses Sonic

S9



Art. no. ASE27600300000

Basic tool set VAS 275 001



After a long selection procedure, Volkswagen has decided to start a collaboration with Sonic Equipment. Especially for Volkswagen Sonic has developed 2 toolboxes, based on the S9 and S12 toolbox. These toolboxes will be delivered in the Volkswagen RAL colors and can be supplied with foam inlays specially developed for Volkswagen. The range consists of a basic tool set in foam inlays and additional extension sets for Audi, VW and body. These products are exclusively available at Volkswagen and their distribution centers.

Volkswagen chooses Sonic

S12



02

Art. no. ASE27600100000

Basic tool set VAS 275 001



Audi tool set VAS 275 001/1

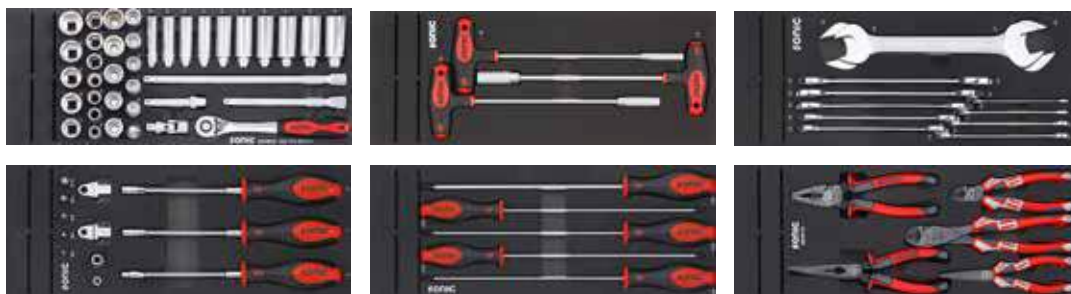

Body repair tool set VAS 275 001/3



Volkswagen tool set VAS 275 001/2





**WORK
EFFICIENT
WORK
WITH SONIC**



S9 topbox

02



M
1X 570 X 370MM

Art. no. 720628

S9 topbox
3 drawers filled with **206-PCS** tools

Art. no. 720634

S9 topbox **trolley**
3 drawers filled with **206-PCS** tools

1 602904



2 316001



3 601707



Art. no. 728528

S9 topbox
4 drawers filled with **285-PCS** tools

Art. no. 728534

S9 topbox **trolley**
4 drawers filled with **285-PCS** tools

1 112102



2 310101



3 604002



4 602302



Filled storage solutions

Filled portable case

Art. no. 713201

Filled carry case with **132-PCS** tools

Art. no. 47502

Empty carry case **XL** (made in EU)



SCREWDRIVER PH



ART. NO.	CONTENTS
----------	----------

1311	Screwdriver PH.1
------	------------------

1312	Screwdriver PH.2
------	------------------

1313	Screwdriver PH.3
------	------------------

SLOTTED SCREWDRIVER



ART. NO.	CONTENTS
----------	----------

13303	Slotted screwdriver 3mm
-------	-------------------------

13304	Slotted screwdriver 4mm
-------	-------------------------

13355	Slotted screwdriver 5.5mm
-------	---------------------------

13365	Slotted screwdriver 6.5mm
-------	---------------------------

SCREWDRIVER TX



ART. NO.	CONTENTS
----------	----------

13610	Screwdriver T10
-------	-----------------

13615	Screwdriver T15
-------	-----------------

13620	Screwdriver T20
-------	-----------------

13625	Screwdriver T25
-------	-----------------

13627	Screwdriver T27
-------	-----------------

13630	Screwdriver T30
-------	-----------------

COMBINATION PLIERS



ART. NO.	CONTENTS
----------	----------

4311175	Combination pliers 7"
---------	-----------------------

LONG NOSE PLIERS



ART. NO.	CONTENTS
----------	----------

4321200	Long nose pliers 8"
---------	---------------------

DIAGONAL PLIERS



ART. NO.	CONTENTS
----------	----------

4341175	Diagonal pliers 7"
---------	--------------------

COMBINATION WRENCH



ART. NO.	CONTENTS
----------	----------

601401	Combination wrench set in pouch, 14-pcs 6, 7, 8, 9, 10, 11, 12, 13, 14, 15, 16, 17, 19, 22mm
--------	---

WATERPUMP PLIERS



ART. NO.	CONTENTS
----------	----------

4351180	Waterpump pliers 7"
---------	---------------------

4351250	Waterpump pliers 10"
---------	----------------------

ADJUSTABLE WRENCH



ART. NO.	CONTENTS
----------	----------

42302150	Adjustable wrench 6"
----------	----------------------

42301250	Adjustable wrench 10"
----------	-----------------------

WIRE STRIPPER



ART. NO.	CONTENTS
----------	----------

4471250	Wire stripper 10"
---------	-------------------

GRIP CHISEL



ART. NO.	CONTENTS
----------	----------

45112160	Grip chisel 160mml 12
----------	-----------------------

45118190	Grip chisel 190mml 18
----------	-----------------------

GRIP TAPER PUNCH



ART. NO.	CONTENTS
----------	----------

4553185	Grip taper punch 185mml 3
---------	---------------------------

MACHINIST HAMMER



ART. NO.	CONTENTS
----------	----------

4611400	Machinist hammer 400gr fibre handle TPR cover
---------	---

UTILITY KNIFE



ART. NO.	CONTENTS
----------	----------

46806	Utility knife including 10 blades
-------	-----------------------------------

MEASURING TAPE



ART. NO.	CONTENTS
----------	----------

47013	Measuringtape 5 meter
-------	-----------------------

TELESCOPIC MAGNET



ART. NO.	CONTENTS
----------	----------

4820110	Telescopic magnet
---------	-------------------

FLASH PEN



ART. NO.	CONTENTS
----------	----------

4821105	Flash Pen
---------	-----------

HEX KEY



ART. NO.	CONTENTS
----------	----------

601008	Hex ball key set extra long, 10-pcs
--------	-------------------------------------

TX KEY



ART. NO.	CONTENTS
----------	----------

600902	TX key set extra long, 9-pcs T10, T15, T20, T25, T27, T30, T40
--------	---

FLANK SOCKET SET



ART. NO.	CONTENTS
----------	----------

104601	Socket set 1/4", 46-pcs
--------	-------------------------

SOCKET SET



ART. NO.	CONTENTS
----------	----------

302403	1/2" socket set MBS, 24-pcs
--------	-----------------------------

Filled portable case trolley

Art. no. 713202

Filled portable case trolley with **132-PCS** tools

Art. no. 47503

Empty portable case trolley **XL** (made in EU)



SCREWDRIVER PH



ART. NO.	CONTENTS
1311	Screwdriver PH.1
1312	Screwdriver PH.2
1313	Screwdriver PH.3

SLOTTED SCREWDRIVER



ART. NO.	CONTENTS
13303	Slotted screwdriver 3mm
13304	Slotted screwdriver 4mm
13355	Slotted screwdriver 5.5mm
13365	Slotted screwdriver 6.5mm

SCREWDRIVER TX



ART. NO.	CONTENTS
13610	Screwdriver T10
13615	Screwdriver T15
13620	Screwdriver T20
13625	Screwdriver T25
13627	Screwdriver T27
13630	Screwdriver T30

COMBINATION PLIERS



ART. NO.	CONTENTS
4311175	Combination pliers 7"

LONG NOSE PLIERS



ART. NO.	CONTENTS
4321200	Long nose pliers 8"

DIAGONAL PLIERS



ART. NO.	CONTENTS
4341175	Diagonal pliers 7"

COMBINATION WRENCH



ART. NO.	CONTENTS
601401	Combination wrench set in pouch, 14-pcs 6, 7, 8, 9, 10, 11, 12, 13, 14, 15, 16, 17, 19, 22mm

WATERPUMP PLIERS



ART. NO.	CONTENTS
4351180	Waterpump pliers 7"
4351250	Waterpump pliers 10"

ADJUSTABLE WRENCH



ART. NO.	CONTENTS
42302150	Adjustable wrench 6"
42301250	Adjustable wrench 10"

WIRE STRIPPER



ART. NO.	CONTENTS
4471250	Wire stripper 10"

GRIP CHISEL



ART. NO.	CONTENTS
45112160	Grip chisel 160mml 12
45118190	Grip chisel 190mml 18

GRIP TAPER PUNCH



ART. NO.	CONTENTS
4553185	Grip taper punch 185mml 3

MACHINIST HAMMER



ART. NO.	CONTENTS
4611400	Machinist hammer 400gr fibre handle TPR cover

UTILITY KNIFE



ART. NO.	CONTENTS
46806	Utility knife including 10 blades

MEASURING TAPE



ART. NO.	CONTENTS
47013	Measuringtape 5 meter

TELESCOPIC MAGNET



ART. NO.	CONTENTS
4820110	Telescopic magnet

FLASH PEN



ART. NO.	CONTENTS
4821105	Flash Pen

HEX KEY



ART. NO.	CONTENTS
601008	Hex ball key set extra long, 10-pcs

TX KEY



ART. NO.	CONTENTS
600902	TX key set extra long, 9-pcs T10, T15, T20, T25, T27, T30, T40

FLANK SOCKET SET



ART. NO.	CONTENTS
104601	Socket set 1/4", 46-pcs

SOCKET SET



ART. NO.	CONTENTS
302403	1/2" socket set MBS, 24-pcs

TOOL BAG FOR PROFESSIONAL USE

- Art. no. 47799 **EMPTY TOOL BAG**
Art. no. 708401 **TOOL BAG WITH BASIC FILLING, 84-PCS**
Art. no. 711201 **TOOL BAG WITH ADVANCED FILLING 112-PCS**

A
ADVANCED



- Measurements Tool bag (L x W x H): 33 x 24 x 47cm
- Volume: 16L
- Empty weight: 2,6kg
- Max loadcapacity: 20kg

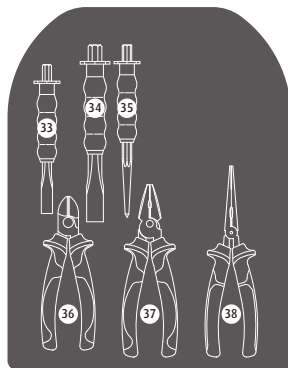
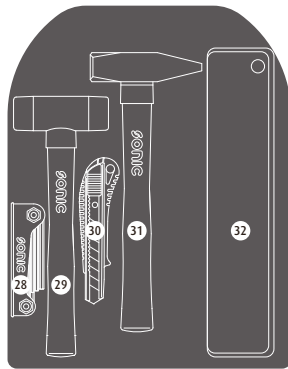
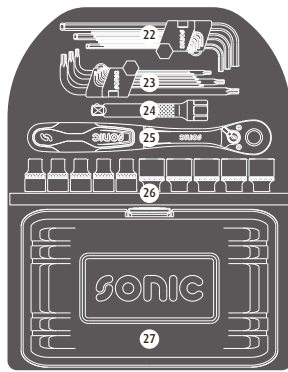
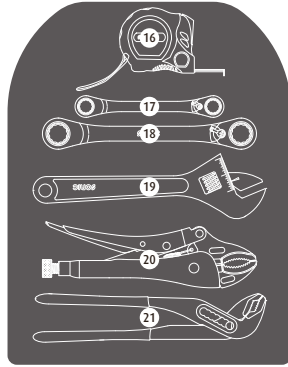
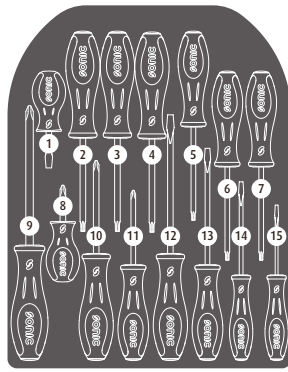

	NO	Basic	Advanced	Sonic NO	Size	Length
	1		V	133055S	5.5mm	104mm
	2		V	13630	T30	215mm
	3		V	13627	T27	215mm
	4		V	13625	T25	215mm
	5		V	13620	T20	203mm
	6		V	13615	T15	203mm
	7		V	13610	T10	203mm
	8		V	1312S	PH.2	104mm
	9	V	V	1313	PH.3	274mm
	10	V	V	1312	PH.2	215mm
	11	V	V	1311	PH.1	183mm
	12	V	V	13365	6.5mm	265mm
	13	V	V	13355	5.5mm	228mm
	14	V	V	13304	4mm	192mm
	15	V	V	13303	3mm	167mm
	16	V	V	47013	5M	81mm
	17		V	4170401	8-10, 12-13	160mm
	18		V	4170402	16-17, 18-19	230mm
	19	V	V	42301250	10"	250mm
	20	V	V	4380250	10"	230mm
	21	V	V	4352250	10"	250mm
	22		V	601008	1.27, 1.5, 2, 2.5, 3, 4, 5, 6, 8, 10mm	
	23		V	600902	T10, T15, T20, T25, T27, T30, T40, T45, T50	
	24		V	7143125	12.5 1/2"	125mm
	25	V	V	7121503	12.5 1/2"	262mm
	26	V	V	301201	12.5 1/2"	8, 9, 10, 11, 12, 13, 14, 15, 16, 17, 18, 19mm
	27	V	V	103502	6.3 1/4"	Socket & bit 1/4" 35PCS
	28	V		600713		2.5, 3, 4, 5, 6, 8, 10mm
	29		V	4620400		40mm
	30	V	V	46806		157mm
	31	V	V	4611400	400GR	310mm
	32	V	V	601409		6, 7, 8, 9, 10, 11, 12, 13, 14, 15, 16, 17, 19, 22mm
	33		V	45112160		12mm
	34		V	45118190		18mm
	35		V	4564185		4mm
	36	V	V	4341175	7"	170mm
	37		V	4311175	7"	190mm
	38	V	V	4321200	8"	200mm



Service topbox

XS

472 X 202MM



TOPBOX **TOOLS** 96 PCS

Art. no. 709601

Service topbox filled with **96-PCS** tools

1 602402



2 600929

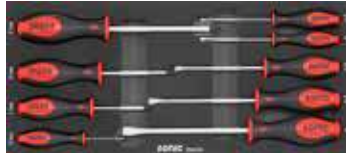

3 305101



4 102502

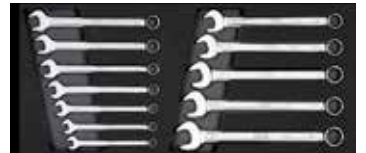

TOPBOX **TOOLS** 47 PCS

Art. no. 704721

Service topbox filled with **47-PCS** tools

SPECIALLY DESIGNED FOR KARTING

1 102502



2 601018



3 601112



4 47030



Service topbox

XS

472 X 202MM

SPECIALLY DESIGNED FOR MOTORCYCLES



TOPBOX **TOOLS** 89 PCS

Art. no. 708971

Service topbox with lid filled with **89-PCS** tools

1 600720



2 103203



3 203103



1 601910



Portable toolbox

02



Art. no. 706201

Toolbox 5 trays
filled with **62-PCS** tools



AVIATION A&P SOLUTIONS FROM SONIC

Our Aviation Airframe and Powerplant (A&P) Solutions are designed and manufactured by Sonic to fill the missing piece for aviation technicians and students who are starting their journey as A&P technicians. We created comprehensive solutions with direction from aviation industry experts. Our solutions are perfect for anyone working on aircraft or any plane and are the perfect foundation for every rising and experienced A&P technician to perform efficiently. We created Basic, Intermediate, and Advanced aviation solutions that present you suitable options, depending on the caliber of storage and tools desired. Nothing matches our level of aviation offerings that create organization, increase efficiency and adds value to your education.



S9 toolbox

SPECIALLY DESIGNED FOR AVIATION

M

1X 570 X 370MM



02

Art. no. 726331

S9 toolbox 4 drawers filled with **263-PCS** tools

1 610301



2 108601



3 604906



4 602503





02



S12XD toolbox

SPECIALLY DESIGNED FOR AVIATION

Art. no. 745446

S12XD toolbox 5 drawers filled with **454-PCS** tools



1X 745 X 570MM

1 219401



2 308601



3 605901

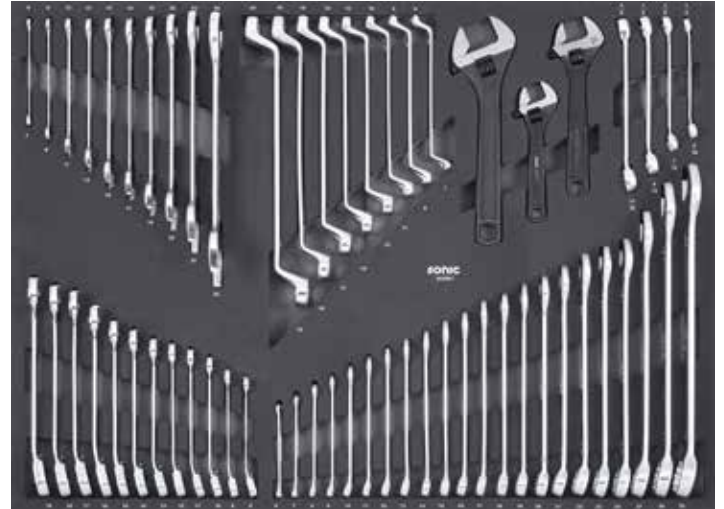

4 605201



5 606301



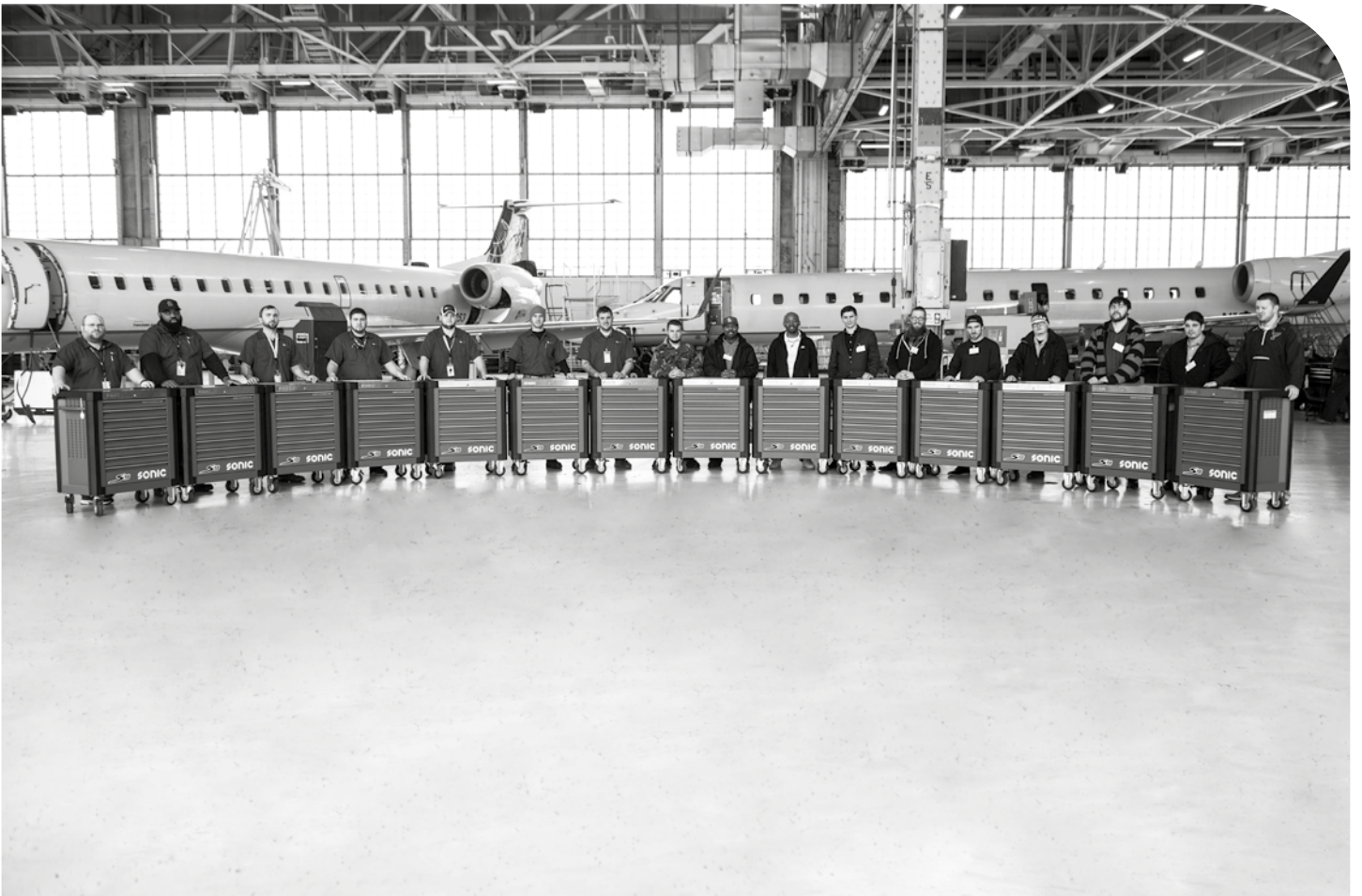

**WORK
EFFICIENT
WORK
WITH SONIC**



***WORK
EFFICIENT
WORK
WITH SONIC***



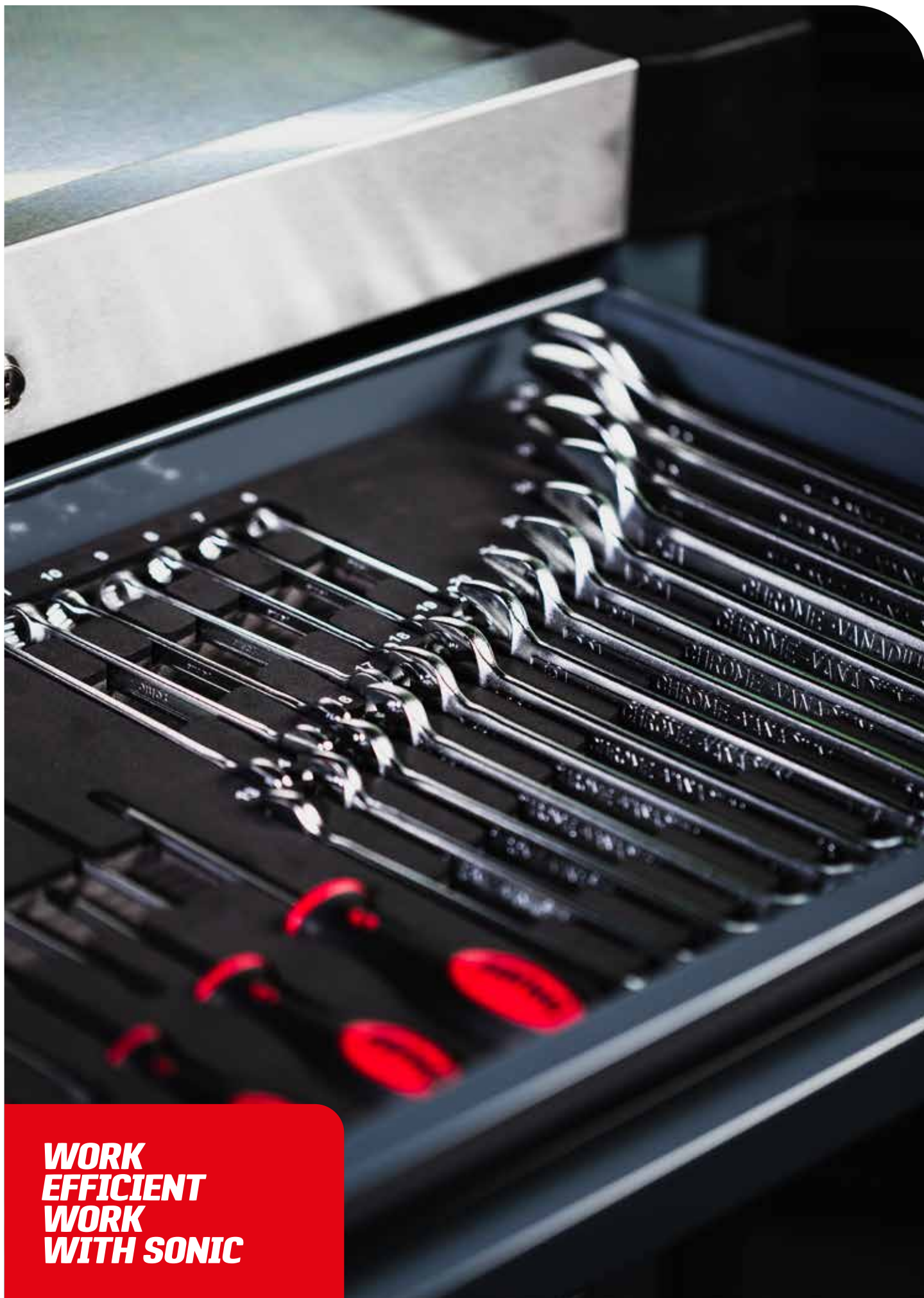

**WORK
EFFICIENT
WORK
WITH SONIC**



SONIC FOAM SYSTEM (SFS)

Work faster, more efficient &
keep your set complete.

03 > Sonic Foam System (SFS)



1/3 190 X 370MM



> Drawer foam system
190 x 370mm

PAGE 120



IX 570 X 370MM



> Drawer foam system
570 x 370mm

PAGE 129



IX 745 X 435MM



> Drawer foam system
745 x 435mm

PAGE 147



IX 745 X 570MM

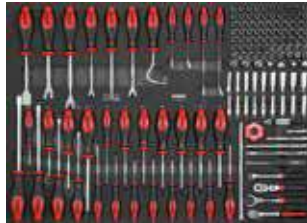

> Drawer foam system
745 x 570mm

PAGE 156



Independent time efficiency studies have **confirmed the effectiveness of our Sonic Foam System** with remarkable results.

20% FASTER RETRIEVAL AND RETURN USING SONIC FOAM SYSTEM

TIME IS MONEY

78% FASTER INVENTORY OF TOOLBOX USING SONIC FOAM SYSTEM

PEACE OF MIND

80% REDUCED MISPLACED TOOLS USING SONIC FOAM SYSTEM

RISIKO GEGEN ERTRAG



XS
472 X 202MM

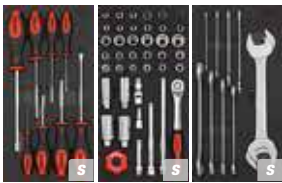

S S S
1/3 190 X 370MM



M
1X 570 X 370MM



L
1X 745 X 435MM



XL
1X 745 X 570MM

Sonic Foam System. Extra Small

Compatible with this toolbox:

Sonic Foam System. Small

Compatible with these storage solutions:



Sonic Foam System. Medium

Compatible with these storage solutions:



Sonic Foam System. Large

Compatible with these storage solutions:



Sonic Foam System. Extra Large

Compatible with these storage solutions:



Sonic Foam System (SFS)

600823 - SCREWDRIVER SET, SFS 1/3, 8-PCS

S S S

190 X 370MM

680 GRAM



TOOLS	ART. NO.	CONTENTS
	1310...12	3 Screwdriver PH, PH.0, PH.1, PH.2
	13303...08	5 Screwdriver slotted, 3, 4, 5.5, 6.5, 8mm

FOR A COMPLETE INVENTORY ORDER LIST SEE OUR WEBSITE

600627 - LONG TX SCREWDRIVER SET SFS 1/3, 6-PCS

S S S

190 X 370MM

816 GRAM

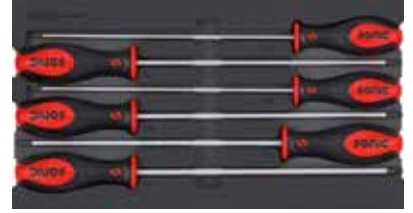

TOOLS	ART. NO.	CONTENTS
	13625015...40	6 Screwdriver extra long, TX T15, T20, T25, T27, T30, T40

FOR A COMPLETE INVENTORY ORDER LIST SEE OUR WEBSITE

600625 - LONG SCREWDRIVER SET SFS 1/3, 6-PCS

S S S

190 X 370MM

654 GRAM

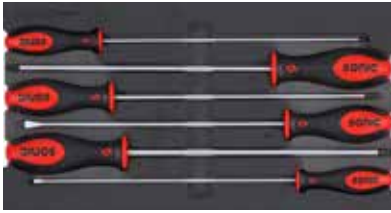

TOOLS	ART. NO.	CONTENTS
	1342503...06	3 Screwdriver extra long, hex 3, 4, 6mm
	1312502	1 Screwdriver extra long, PH.2
	13325004...55	2 Screwdriver extra long, 4, 5.5mm

FOR A COMPLETE INVENTORY ORDER LIST SEE OUR WEBSITE

600513 - GO-THROUGH SCREWDRIVER SET, SFS 1/3, 5-PCS

S S S

190 X 370MM

740 GRAM



TOOLS	ART. NO.	CONTENTS
	15101...02	2 Hammer go-through screwdriver PH, PH.1, PH.2
	1530155...08	3 Hammer go-through screwdriver slotted, 5.5, 6.5, 8mm

FOR A COMPLETE INVENTORY ORDER LIST SEE OUR WEBSITE

600626 - LONG SCREWDRIVER SET SFS 1/3, 6-PCS

S S S

190 X 370MM

638 GRAM

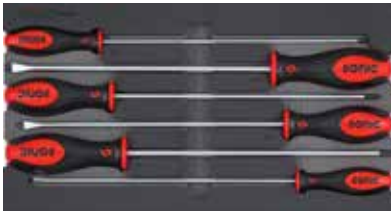

TOOLS	ART. NO.	CONTENTS
	1342503...05	3 Screwdriver extra long, hex 3, 4, 5mm
	13325004...65	3 Screwdriver extra long, 4, 5.5, 6.5mm

FOR A COMPLETE INVENTORY ORDER LIST SEE OUR WEBSITE

600826 - VDE SCREWDRIVER SET, SFS 1/3, 8-PCS

S S S

190 X 370MM

540 GRAM



TOOLS	ART. NO.	CONTENTS
	1610...2	3 VDE screwdriver PH, PH.0, PH.1, PH.2
	16325...65	4 VDE screwdriver slotted, 2.5, 4, 5.5, 6.5mm
	47016	1 Electric main tester 120-250

FOR A COMPLETE INVENTORY ORDER LIST SEE OUR WEBSITE

600824 - TX SCREWDRIVER SET, SFS 1/3, 8-PCS

S S S

190 X 370MM

700 GRAM



TOOLS	ART. NO.	CONTENTS
	13608...40	8 Screwdriver TX, T8, T10, T15, T20, T25, T27, T30, T40

FOR A COMPLETE INVENTORY ORDER LIST SEE OUR WEBSITE

600717 - SOCKET SCREWDRIVER HEX SET, SFS 1/3, 7-PCS

S S S

190 X 370MM

1080 GRAM



TOOLS	ART. NO.	CONTENTS
	12425006...11	5 Hex nut driver 6, 8, 9, 10, 11mm
	47537...38	2 Flexible hex nut driver 7, 8mm

FOR A COMPLETE INVENTORY ORDER LIST SEE OUR WEBSITE

600718 - HEX BALL GRIP KEY SET, SFS 1/3, 7-PCS

S S S

190 X 370MM

670 GRAM



TOOLS	ART. NO.	CONTENTS
	19502025...08	7 Hex ball point grip key 2.5, 3, 4, 5, 6, 7, 8mm

FOR A COMPLETE INVENTORY ORDER LIST SEE OUR WEBSITE

600913 - HEX KEY WRENCH SET 3 TIP T-HANDLE, SFS 1/3, 9-PCS

S S S

190 X 370MM

860 GRAM

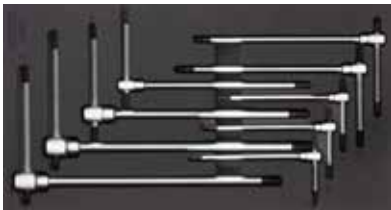

TOOLS	ART. NO.	CONTENTS
	4840102...08	9 3 tip hex key T-handle 2, 2.5, 3, 4, 4.5, 5, 6, 7, 8mm

FOR A COMPLETE INVENTORY ORDER LIST SEE OUR WEBSITE

600719 - T-HANDLE TX KEY WRENCH SET, SFS 1/3, 7-PCS

S S S

190 X 370MM

534 GRAM



TOOLS	ART. NO.	CONTENTS
	1960210...40	7 T-handle TX key wrench T10, T15, T20, T25, T27, T30, T40

FOR A COMPLETE INVENTORY ORDER LIST SEE OUR WEBSITE

600914 - TX KEY SET, 3 TIP T-HANDLE, SFS 1/3, 9-PCS

S S S

190 X 370MM

5900 GRAM



TOOLS	ART. NO.	CONTENTS
	4840210...50	9 3 tip star key T-handle T10, T15, T20, T25, T27, T30, T40, T45, T50

FOR A COMPLETE INVENTORY ORDER LIST SEE OUR WEBSITE

106303 - FLANK SOCKET SET 1/4" 6 PT., SFS 1/3, 61-PCS

S S S

190 X 370MM

1480 GRAM

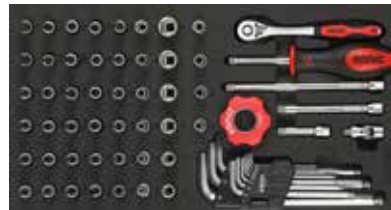

TOOLS	ART. NO.	CONTENTS
	21505...13	10 Flank socket 1/4", 6 pt. 5, 5.5, 6, 7, 8, 9, 10, 11, 12, 13mm
	21604...10	6 Socket TX 1/4", TX E4, E5, E6, E7, E8, E10
	601006	10 Hex ball long key set 10-pcs
	7121501	1 Ratchet 1/4" 60 teeth
	7110301	1 Disc ratchet 1/4" 72 teeth
	72401	1 Spinner 1/4" 150mm
	7141050...150	3 Extension 1/4" 50, 100, 150mm
	71511	1 Universal joint 1/4"
	8113701...02	2 Bit socket PH 1/4", PH.1, PH.2
	8143703...08	6 Bit socket hex 1/4", 3, 4, 5, 6, 7, 8mm
	8163706...40	11 Bit socket TX 1/4", T6, T7, T8, T9, T10, T15, T20, T25, T27, T30, T40
	8173706...40	11 Bit socket TX tamperproof 1/4", T6H, T7H, T8H, T9H, T10H, T15H, T20H, T25H, T27H, T30H, T40H

FOR A COMPLETE INVENTORY ORDER LIST SEE OUR WEBSITE

110201 - BIT SOCKET SET 1/4", SFS 1/3, 102-PCS

S S S

190 X 370MM

2168 GRAM



TOOLS	ART. NO.	CONTENTS
	21504...13	12 Flank socket 1/4", 6 pt. 4, 4.5, 5, 5.5, 6, 7, 8, 9, 10, 11, 12, 13mm
	2155004...13	12 Flank deep socket 1/4", 6 pt. 4, 4.5, 5, 5.5, 6, 7, 8, 9, 10, 11, 12, 13mm
	21604...10	6 Socket TX 1/4", E4, E5, E6, E7, E8, E10
	2165004...10	6 Deep socket TX 1/4", E4, E5, E6, E7, E8, E10
	7121501	1 Ratchet 1/4" 60 teeth
	7110301	1 Disc ratchet 1/4" 72 teeth
	72401	1 Spinner 1/4" 150mm
	7141050...150	3 Extension 1/4" 50, 100, 150mm
	7261250	1 Wobble extension 1/4" 250mm
	71511	1 Universal joint 1/4"
	71921	1 Adaptor 3/8"(F) x 1/4"(M)
	71912	1 Adaptor 1/4"(F) x 3/8"(M)
	72225	1 Magnet socket pick-up 1/4"
	8113700...02	3 Bit socket PH 1/4", PH.0, PH.1, PH.2
	8123700...02	3 Bit socket PZ 1/4", PZ.0, PZ.1, PZ.2
	81337055...65	2 Bit socket slotted 1/4", 5.5, 6.5mm
	8143703...10	9 Bit socket hex 1/4", 3, 4, 5, 5.5, 6, 7, 8, 9, 10mm
	8153708...45	9 Tamper-resistant 1/4", TX plus (5 lobes) 8IPR, 10IPR, 15IPR, 20IPR, 25IPR, 27IPR, 30IPR, 40IPR, 45IPR
	8163708...40	9 Bit socket TX 1/4", T8, T9, T10, T15, T20, T25, T27, T30, T40
	8173708...40	9 Bit socket TX tamperproof 1/4", T8H, T9H, T10H, T15H, T20H, T25H, T27H, T30H, T40H
	8183704...10	5 Bit socket spline 1/4", M4, M5, M6, M8, M10
	8193704...10	6 Bit socket ribe 1/4", M4, M5, M6, M7, M8, M10

FOR A COMPLETE INVENTORY ORDER LIST SEE OUR WEBSITE

Sonic Foam System (SFS)

201401 - COMBINATION SET 3/8", SFS 1/3, 14-PCS

S S S

190 X 370MM



TOOLS	ART. NO.	CONTENTS
	7121502	1 Ratchet 3/8", 60 teeth
	7110102	1 Flexible ratchet 3/8", 45 teeth
	7110302	1 Disc ratchet 3/8", 72 teeth
	7272250	1 Swivel grip handle 3/8" 250mm
	7142044...250	4 Extension 3/8", 44, 75, 150, 250mm
	71521	1 Universal joint 3/8"
	71632	1 Adaptor for extension 1/2"(F) x 3/8"(M)
	7172214	1 Spark plug clip socket 3/8", 12 pt. 14mm
	7172216...21	3 Spark plug clip socket 3/8", 16, 18, 21mm

FOR A COMPLETE INVENTORY ORDER LIST SEE OUR WEBSITE

204101 - BIT SOCKET SET 3/8", SFS 1/3, 41-PCS

S S S

190 X 370MM



TOOLS	ART. NO.	CONTENTS
	22508...19	12 Flank socket 3/8", 6 pt. 8, 9, 10, 11, 12, 13, 14, 15, 16, 17, 18, 19mm
	22607...14	6 Socket TX 3/8", E7, E8, E10, E11, E12, E14
	7121502	1 Ratchet 3/8", 60 teeth
	7110302	1 Disc ratchet 3/8", 72 teeth
	7172214	1 Spark plug clip socket 3/8", 12 pt. 14mm
	7171216...21	3 Spark plug socket 3/8", 16, 18, 21mm
	7142044...200	4 Extension 3/8", 44, 75, 150, 200mm
	71521	1 Universal joint 3/8"
	8244806...12	6 Bit socket hex 3/8", 6, 7, 8, 9, 10, 12mm
	8264825...50	6 Bit socket TX 3/8", T25, T27, T30, T40, T45, T50

FOR A COMPLETE INVENTORY ORDER LIST SEE OUR WEBSITE

202301 - DEEP SOCKET SET 3/8", SFS 1/3, 23-PCS

S S S

190 X 370MM



TOOLS	ART. NO.	CONTENTS
	2256310...22	13 Flank deep socket 3/8", 6 pt. 10, 11, 12, 13, 14, 15, 16, 17, 18, 19, 20, 21, 22mm
	2266306...20	10 Deep socket TX 3/8", E6, E7, E8, E10, E11, E12, E14, E16, E18, E20

FOR A COMPLETE INVENTORY ORDER LIST SEE OUR WEBSITE

208001 - BIT SOCKET SET 3/8", SFS 1/3, 80-PCS

S S S

190 X 370MM



TOOLS	ART. NO.	CONTENTS
	22510...22	12 Flank socket 3/8", 6 pt. 10, 11, 12, 13, 14, 15, 16, 17, 18, 19, 21, 22mm
	2256310...22	12 Flank deep socket 3/8", 6 pt. 10, 11, 12, 13, 14, 15, 16, 17, 18, 19, 21, 22mm
	22610...20	7 Socket TX 3/8", E10, E11, E12, E14, E16, E18, E20
	2266310...20	7 Deep socket TX 3/8", E10, E11, E12, E14, E16, E18, E20
	8214801...03	3 Bit socket PH 3/8", PH.1, PH.2, PH.3
	8224801...03	3 Bit socket PZ 3/8", PZ.1, PZ.2, PZ.3
	8234806	1 Bit socket slotted 3/8", 6mm
	8244805...12	7 Bit socket hex 3/8", 5, 6, 7, 8, 9, 10, 12mm
	8264820...50	7 Bit socket TX 3/8", T20, T25, T27, T30, T40, T45, T50
	8274820...50	7 Bit socket TX tamperproof 3/8", T20H, T25H, T27H, T30H, T40H, T45H, T50H
	8284804...12	7 Bit socket spline 3/8", M4, M5, M6, M8, M9, M10, M12
	8294805...12	7 Bit socket ribe 3/8", M5, M6, M7, M8, M9, M10, M12

FOR A COMPLETE INVENTORY ORDER LIST SEE OUR WEBSITE

203001 - BIT SOCKET SET 3/8", SFS 1/3, 30-PCS

S S S

190 X 370MM



TOOLS	ART. NO.	CONTENTS
	8249003...10	8 Bit socket hex 3/8", 90mm 3, 4, 5, 6, 7, 8, 9, 10mm
	8269008...50	10 Bit socket TX 3/8", 90mm T8, T10, T15, T20, T25, T27, T30, T40, T45, T50
	8289005...12	6 Bit socket spline 3/8", 90mm M5, M6, M8, M9, M10, M12
	8299005...12	6 Bit socket ribe 3/8", 90mm M5, M6, M8, M9, M10, M12

FOR A COMPLETE INVENTORY ORDER LIST SEE OUR WEBSITE

300608 - ACCESSORY SET 1/2", SFS 1/3, 6-PCS

S S S

190 X 370MM



TOOLS	ART. NO.	CONTENTS
	7121503	1 Ratchet 1/2" 60 teeth
	7273380	1 Swivel grip handle 1/2" 380mm
	7143125...250	2 Extension 1/2" 125, 250mm
	71531	1 Universal joint 1/2"
	71623	1 Adaptor for extension 3/8"(F) x 1/2"(M)

FOR A COMPLETE INVENTORY ORDER LIST SEE OUR WEBSITE

300908 - ACCESSORY SET 1/2", SFS 1/3, 9-PCS

S S S

190 X 370MM

2758 GRAM



TOOLS	ART. NO.	CONTENTS
	7121503	1 Ratchet 1/2" 60 teeth
	7273380	1 Swivel grip handle 1/2" 380mm
	7143125...250	2 Extension 1/2" 125, 250mm
	71531	1 Universal joint 1/2"
	71623	1 Adaptor for extension 3/8"(F) x 1/2"(M)
	3310117...21	3 Wheel socket 1/2", 6 pt. 17, 19, 21mm

FOR A COMPLETE INVENTORY ORDER LIST SEE OUR WEBSITE

302301 - ACCESSORY SET 1/2", SFS 1/3, 23-PCS

S S S

190 X 370MM

2894 GRAM



TOOLS	ART. NO.	CONTENTS
	23508...32	12 Flank socket 1/2", 6 pt. 8, 10, 11, 12, 13, 14, 15, 16, 17, 18, 19, 21, 22, 23, 24, 26, 27, 30, 32mm
	7121503	1 Ratchet 1/2" 60 teeth
	7143125...250	2 Extension 1/2" 125, 250mm
	71531	1 Universal joint 1/2"
	71623	1 Adaptor for extension 3/8"(F) x 1/2"(M)

FOR A COMPLETE INVENTORY ORDER LIST SEE OUR WEBSITE

303805 - BIT SOCKET SET 1/2", SFS 1/3, 38-PCS

S S S

190 X 370MM

3226 GRAM



TOOLS	ART. NO.	CONTENTS
	23510...32	20 Flank socket 1/2", 6 pt. 10, 11, 12, 13, 14, 15, 16, 17, 18, 19, 20, 21, 22, 23, 24, 26, 27, 28, 30, 32mm
	23610...24	8 Socket TX 1/2", E10, E11, E12, E14, E16, E18, E20, E24
	83406208...17	5 Bit socket hex 1/2", 8, 10, 12, 14, 17mm
	83606245...70	5 Bit socket TX 1/2", T45, T50, T55, T60, T70

FOR A COMPLETE INVENTORY ORDER LIST SEE OUR WEBSITE

305605 - BIT SOCKET SET 1/2", SFS 1/3, 56-PCS

S S S

190 X 370MM

4994 GRAM



TOOLS	ART. NO.	CONTENTS
	23510...32	20 Flank socket 1/2", 6 pt. 10, 11, 12, 13, 14, 15, 16, 17, 18, 19, 20, 21, 22, 23, 24, 26, 27, 28, 30, 32mm
	23614...24	6 Socket TX 1/2", E14, E16, E18, E20, E22, E24
	83406208...17	6 Bit socket hex 1/2", 8, 9, 10, 12, 14, 17mm
	83606240...70	6 Bit socket TX 1/2", T40, T45, T50, T55, T60, T70
	83706240...70	6 Bit socket TX tamperproof 1/2", T40H, T45H, T50H, T55H, T60H, T70H
	83806209...16	5 Bit socket spline 1/2", M9, M10, M12, M14, M16
	83806216T	1 Bit socket spline 1/2", M16-T
	83906209...14	6 Bit socket ribe 1/2", M9, M10, M11, M12, M13, M14

FOR A COMPLETE INVENTORY ORDER LIST SEE OUR WEBSITE

301603 - IMPACT DEEP SOCKET SET 1/2", SFS 1/3, 16-PCS

S S S

190 X 370MM

4504 GRAM



TOOLS	ART. NO.	CONTENTS
	3358513...32	13 Impact deep socket 1/2", 6 pt. 13, 14, 15, 16, 17, 18, 19, 21, 22, 24, 27, 30, 32mm
	3398530...36	2 Impact deep socket 1/2", 12 pt. 30, 36mm
	7343125	1 Impact extension 1/2" 125mm

FOR A COMPLETE INVENTORY ORDER LIST SEE OUR WEBSITE

302003 - DEEP SOCKET SET 1/2", SFS 1/3, 20-PCS

S S S

190 X 370MM

3760 GRAM



TOOLS	ART. NO.	CONTENTS
	2357710...32	20 Flank deep socket 1/2", 6 pt. 10, 11, 12, 13, 14, 15, 16, 17, 18, 19, 20, 21, 22, 23, 24, 26, 27, 28, 30, 32mm

FOR A COMPLETE INVENTORY ORDER LIST SEE OUR WEBSITE

302204 - SOCKET & BIT SOCKET SET 1/2", SFS 1/3, 22-PCS

S S S

190 X 370MM

2490 GRAM



TOOLS	ART. NO.	CONTENTS
	2367710...24	8 Deep socket TX 1/2", E10, E11, E12, E14, E16, E18, E20, E24
	83610030...70	7 Bit socket TX 1/2", 100mm T30, T40, T45, T50, T55, T60, T70
	83710030...70	7 Bit socket TX tamperproof 1/2", 100mm T30H, T40H, T45H, T50H, T55H, T60H, T70H

FOR A COMPLETE INVENTORY ORDER LIST SEE OUR WEBSITE

Sonic Foam System (SFS)

302104 - BIT SOCKET SET 1/2", SFS 1/3, 21-PCS

S S S

190 X 370MM

2508 GRAM



TOOLS	ART. NO.	CONTENTS
	83410006...17	8 Bit socket hex 1/2", 100mm 6, 7, 8, 9, 10, 12, 14, 17mm
	83810005...16	8 Bit socket spline 1/2", 100mm M5, M6, M8, M9, M10, M12, M14, M16
	83910008...14	5 Bit socket ribe 1/2", 100mm M8, M9, M10, M12, M14

FOR A COMPLETE INVENTORY ORDER LIST SEE OUR WEBSITE

601017 - FLARE NUT WRENCH SET, SFS 1/3, 10-PCS

S S S

190 X 370MM

1566 GRAM



TOOLS	ART. NO.	CONTENTS
	4110810...2427	7 Flare nut wrench 8x10, 11x13, 12x14, 16x18, 17x19, 19x22, 24x27mm
	4080809...1213	3 Flexible flare nut wrench 8x9, 10x11, 12x13mm

FOR A COMPLETE INVENTORY ORDER LIST SEE OUR WEBSITE

600708 - HINGED SOCKET WRENCH SET, SFS 1/3, 7-PCS

S S S

190 X 370MM

1452 GRAM



TOOLS	ART. NO.	CONTENTS
	4120607...1819	7 Hinged socket wrench 6x7, 8x9, 10x11, 12x13, 14x15, 16x17, 18x19mm

FOR A COMPLETE INVENTORY ORDER LIST SEE OUR WEBSITE

601103 - ANGLE WRENCH SET, SFS 1/3, 11-PCS

S S S

190 X 370MM

2333 GRAM



TOOLS	ART. NO.	CONTENTS
	41308...19	11 Angle wrench 6 pt. 8, 10, 11, 12, 13, 14, 15, 16, 17, 18, 19mm

FOR A COMPLETE INVENTORY ORDER LIST SEE OUR WEBSITE

601016 - DOUBLE OPEN WRENCH SET, SFS 1/3, 10-PCS

S S S

190 X 370MM

1721 GRAM



TOOLS	ART. NO.	CONTENTS
	4140607...3032	10 Double open wrench 6x7, 8x9, 10x11, 12x13, 14x15, 16x17, 18x19, 20x22, 24x27, 30x32mm

FOR A COMPLETE INVENTORY ORDER LIST SEE OUR WEBSITE

601903 - COMBINATION WRENCH SET, SFS 1/3, 19-PCS

S S S

190 X 370MM

2332 GRAM

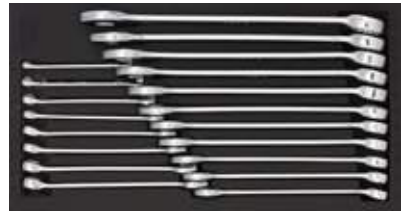

TOOLS	ART. NO.	CONTENTS
	41506...24	19 Combination wrench 6,7, 8, 9, 10, 11, 12, 13, 14, 15, 16, 17, 18, 19, 20, 21, 22, 23, 24mm

FOR A COMPLETE INVENTORY ORDER LIST SEE OUR WEBSITE

601904 - REVERSIBLE RATCHETING & OPEN WRENCH SET, SFS 1/3, 19-PCS

S S S

190 X 370MM

2118 GRAM

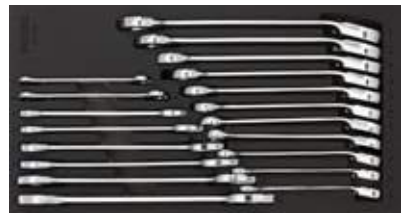

TOOLS	ART. NO.	CONTENTS
	4140607...2022	8 Double open wrench 6x7, 8x9, 10x11, 12x13, 14x15, 16x17, 18x19, 20x22mm
	4170208...19	11 Reversible ratcheting wrench 12 pt. 8, 9, 10, 11, 12, 13, 14, 15, 16, 17, 19mm

FOR A COMPLETE INVENTORY ORDER LIST SEE OUR WEBSITE

601228 - 12 PT. FLAT RING RATCHET SET, SFS 1/3, 12-PCS

S S S

190 X 370MM

1318 GRAM



TOOLS	ART. NO.	CONTENTS
	4170108...19	12 Flat ratcheting wrench 12 pt. 8, 9, 10, 11, 12, 13, 14, 15, 16, 17, 18, 19mm

FOR A COMPLETE INVENTORY ORDER LIST SEE OUR WEBSITE

601229 - 12 PT. REVERSIBLE RATCHETING WRENCH SET, SFS 1/3, 12-PCS

S S S

190 X 370MM

1526 GRAM



TOOLS	ART. NO.	CONTENTS
	4170208...19	12 Reversible ratcheting wrench 12 pt. 8, 9, 10, 11, 12, 13, 14, 15, 16, 17, 18, 19mm

FOR A COMPLETE INVENTORY ORDER LIST SEE OUR WEBSITE

601230 - 12 PT. FLEXIBLE RATCHETING WRENCH SET, SFS 1/3, 12-PCS

S S S

190 X 370MM

1460 GRAM



TOOLS	ART. NO.	CONTENTS
	- 4170308...19	12 Flexible ratcheting wrench 12 pt. 8, 9, 10, 11, 12, 13, 14, 15, 16, 17, 18, 19mm

FOR A COMPLETE INVENTORY ORDER LIST SEE OUR WEBSITE

600709 - COMBINATION WRENCH SET, SFS 1/3, 7-PCS

S S S

190 X 370MM

3087 GRAM

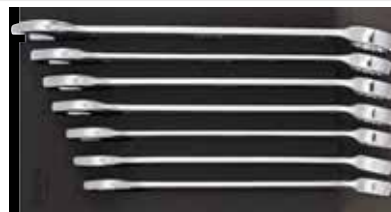

TOOLS	ART. NO.	CONTENTS
	- 41525...32	7 Combination wrench 25, 26, 27, 28, 29, 30, 32mm

FOR A COMPLETE INVENTORY ORDER LIST SEE OUR WEBSITE



601225 - WRENCH SET, SFS 1/3, 12-PCS

S S S

190 X 370MM

1718 GRAM



TOOLS	ART. NO.	CONTENTS
	- 4190607...2022	8 75° offset ring wrench 6x7, 8x9, 10x11, 12x13, 14x15, 16x17, 18x19, 20x22mm
	- 4160608...2024	4 TX wrench E6xE8, E10xE12, E14xE18, E20xE24

FOR A COMPLETE INVENTORY ORDER LIST SEE OUR WEBSITE











602205 - OIL FILTER SET, SFS 1/3, 22-PCS

S S S

190 X 370MM

2180 GRAM



TOOLS	ART. NO.	CONTENTS
	- 4831302	1 Oil filter claw wrench
	- 7142250	1 3/8" extension 250mm
	- 71632	1 Adaptor for extension 1/2"(F) x 3/8"(M)
	4831401...07	7 Square drain plug key 7, 8, 10, 11, 12, 13, 14mm
	4831408...09	2 Square drain plug key 5/16", 3/8"
	4831410	1 Drain plug key 10 (female)
	4831411	1 Triangular drain plug key 10
	4831412...17	6 Hex drain plug key 8, 9, 10, 11, 14, 17
	- 4830801	1 3 jaw oil filter wrench
	- 4450250	1 Oil filter pliers 10"

FOR A COMPLETE INVENTORY ORDER LIST SEE OUR WEBSITE

600435 - 75° OFFSET RING WRENCH SET, SFS 1/3, 4-PCS

S S S

190 X 370MM

2132 GRAM



TOOLS	ART. NO.	CONTENTS
	- 4192123...3032	4 75° offset ring wrench 21x23, 24x27, 25x28, 30x32mm

FOR A COMPLETE INVENTORY ORDER LIST SEE OUR WEBSITE





603004 - WRENCH SET, SFS 1/3, 30-PCS

S S S

190 X 370MM

1930 GRAM



TOOLS	ART. NO.	CONTENTS
	- 42608...17	10 Stubby combination wrench 8, 9, 10, 11, 12, 13, 14, 15, 16, 17mm
	- 42301250	1 Adjustable wrench 10"
	601008	10 Hex ball key set extra long 10-pcs, 1.27, 1.5, 2, 2.5, 3, 4, 5, 6, 8, 10mm
	600902	9 TX key set extra long, 9-pcs

FOR A COMPLETE INVENTORY ORDER LIST SEE OUR WEBSITE

Sonic Foam System (SFS)

600432 - PLIERS SET, SFS 1/3, 4-PCS

S S S

190 X 370MM

1030
GRAM



TOOLS	ART. NO.	CONTENTS
	- 4311175	1 Combination pliers 7"
	- 4321200	1 Long nose pliers 8"
	- 4331200	1 Bent long nose pliers 8"
	- 4341175	1 Diagonal pliers 7"

FOR A COMPLETE INVENTORY ORDER LIST SEE OUR WEBSITE

600434 - VDE PLIERS SET, SFS 1/3, 4-PCS

S S S

190 X 370MM

1532
GRAM



TOOLS	ART. NO.	CONTENTS
	- 4312180	1 VDE combination pliers
	- 4322200	1 VDE long nose pliers
	- 4342160	1 VDE diagonal pliers
	- 4472160	1 VDE stripping pliers

FOR A COMPLETE INVENTORY ORDER LIST SEE OUR WEBSITE

600430 - SNAP RING PLIERS SET, SFS 1/3, 4-PCS

S S S

190 X 370MM

676
GRAM

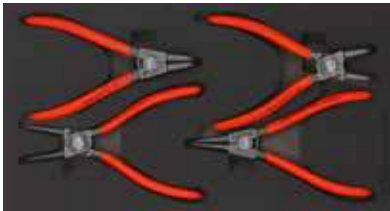

TOOLS	ART. NO.	CONTENTS
	- 43611	1 Snap ring pliers (straight-open)
	- 43612	1 Snap ring pliers (straight-close)
	- 43613	1 Snap ring pliers (bent-open)
	- 43614	1 Snap ring pliers (bent-close)

FOR A COMPLETE INVENTORY ORDER LIST SEE OUR WEBSITE

600825 - PLIERS SET, SFS 1/3, 8-PCS

S S S

190 X 370MM

1532
GRAM



TOOLS	ART. NO.	CONTENTS
	- 4311175	1 Combination pliers 7"
	- 4321200	1 Long nose pliers 8"
	- 4331200	1 Bent long nose pliers 8"
	- 4341175	1 Diagonal pliers 7"
	- 43611	1 Snap ring pliers (straight-open)
	- 43612	1 Snap ring pliers (straight-close)
	- 43613	1 Snap ring pliers (bent-open)
	- 43614	1 Snap ring pliers (bent-close)

FOR A COMPLETE INVENTORY ORDER LIST SEE OUR WEBSITE

600319 - HAMMER SET, SFS 1/3, 3-PCS

S S S

190 X 370MM

2508
GRAM



TOOLS	ART. NO.	CONTENTS
	- 4611400	1 Machinist hammer with ash handle, 512gr
	- 4620400	1 Install hammer soft/hard, with ash handle, 608gr
	- 4631000	1 Stoning hammer with ash handle, 1106gr

FOR A COMPLETE INVENTORY ORDER LIST SEE OUR WEBSITE

601227 - GRIPPED CHISEL & PUNCH SET, SFS 1/3, 12-PCS

S S S

190 X 370MM

1740
GRAM



TOOLS	ART. NO.	CONTENTS
	- 45112160	1 Grip chisel 160mml 12
	- 45116170	1 Grip chisel 170mml 16
	- 45118190	1 Grip chisel 190mml 18
	- 45124220	1 Grip chisel 220mml 24
	- 4527190	1 Grip cape chisel 190mml 7
	- 4533150	1 Grip pin punch 150mml 3
	- 4534180	1 Grip pin punch 180mml 4
	- 4535200	1 Grip pin punch 200mml 5
	- 4536210	1 Grip pin punch 210mml 6
	- 4553185	1 Grip taper punch 185mml 3
	- 4554185	1 Grip taper punch 185mml 4
	- 4564185	1 Grip center punch 185mml 4

FOR A COMPLETE INVENTORY ORDER LIST SEE OUR WEBSITE

03







600614 - FILE SET, SFS 1/3, 6-PCS

S S S

190 X 370MM

700 GRAM

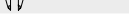

TOOLS	ART. NO.	CONTENTS
	- 46905	1 Triangular file for brakes 8"
	- 46913	1 Round file 8"
	- 46914	1 Triangular file 8"
	- 47003	1 Stainless steel vernier caliper
	- 47004	1 Stainless steel straight ruler 30cm
	- 4811254	1 Steel wire brush

FOR A COMPLETE INVENTORY ORDER LIST SEE OUR WEBSITE









600822 - HOOK SET, SFS 1/3, 8-PCS

S S S

190 X 370MM

1080 GRAM



TOOLS	ART. NO.	CONTENTS
	- 47901	1 Door upholstery panel remover small 100mm
	- 47902	1 Door upholstery panel remover 110mm
	- 47903	1 Scraper
	- 47904	1 Cotter pin puller
	- 47905	1 Radiator hose remover
	- 47906	1 Trim pad tool 1/4" x 115mm
	- 47907	1 Trim pad tool 5/16" x 115mm
	- 47908	1 Door upholstery panel remover 132mm

FOR A COMPLETE INVENTORY ORDER LIST SEE OUR WEBSITE







600705 - PLIERS & TOOLS SET, SFS 1/3, 7-PCS

S S S

190 X 370MM

1640 GRAM



TOOLS	ART. NO.	CONTENTS
	- 4351250	1 Waterpump pliers 10"
	- 4380250	1 Locking pliers 10"
	- 46807	1 Utility knife (incl. 13 blades)
	- 4821301	1 Wedge universal (190x30mm)
	- 47002	1 Feeler gauge 26-pcs
	- 47013	1 Measuring tape 5 meter
	- 4820110	1 Telescopic magnet

FOR A COMPLETE INVENTORY ORDER LIST SEE OUR WEBSITE







600623 - HOOK SET, SFS 1/3, 6-PCS

S S S

190 X 370MM

720 GRAM



TOOLS	ART. NO.	CONTENTS
	- 47904	1 Cotter pin puller
	- 47905	1 Radiator hose remover
	- 47909	1 Straight pick hook
	- 47910	1 Degree hook
	- 47911	1 Full hook
	- 49712	1 Small angle hook

FOR A COMPLETE INVENTORY ORDER LIST SEE OUR WEBSITE

47613 - FOAM SPACER 190X370MM, SFS 1/3

S S S

190 X 370MM

62 GRAM

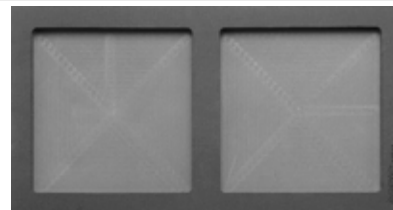

TOOLS	ART. NO.	CONTENTS
-	- 47613	1 Foam spacer

FOR A COMPLETE INVENTORY ORDER LIST SEE OUR WEBSITE

Sonic Foam System (SFS)

106304 - 1/4" SOCKET BIT SAE SET, SFS 1/3, 63-PCS

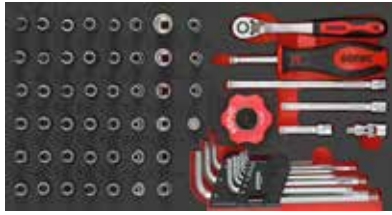

TOOLS	ART. NO.	CONTENTS
	21905...13	9 Flank socket 1/4", 12 pt. 3/16", 7/32", 1/4", 9/32", 5/16", 11/32", 3/8", 7/16", 1/2"
	21604...10	6 Socket TX 1/4", E4, E5, E6, E7, E8, E10
	601006	10 Hex ball long key set 10-pcs
	7121501	1 Ratchet 1/4" 60 teeth
	7110301	1 Disc ratchet 1/4" 72 teeth
	72401	1 Spinner 1/4" 150mm
	7141050...150	3 Extension 1/4", 50, 100, 150mm
	71511	1 Universal joint 1/4"
	72225	1 Magnetic socket pick-up 1/4"
	8113701...02	2 Bit socket PH 1/4", PH.1, PH.2
	81413703...08	6 Bit socket hex 1/4", 1/8", 5/32", 3/16", 7/32", 1/4", 5/16"
	8163706...40	11 Bit socket TX 1/4", T6, T7, T8, T9, T10, T15, T20, T25, T27, T30, T40
	8173706...40	11 Bit socket TX tamperproof 1/4", T6H, T7H, T8H, T9H, T10H, T15H, T20H, T25H, T27H, T30H, T40H

FOR A COMPLETE INVENTORY ORDER LIST SEE OUR WEBSITE

204102 - 3/8" SOCKET BIT SAE SET, SFS 1/3, 41-PCS



TOOLS	ART. NO.	CONTENTS
	22906...18	10 Flank socket 3/8", 12 pt. 1/4", 5/16", 3/8", 7/16", 1/2", 9/16", 5/8", 11/16", 3/4", 13/16"
	22607...18	8 Socket TX 3/8", E7, E8, E10, E11, E12, E14, E16, E18
	7121502	1 Ratchet 3/8" 60 teeth
	7110302	1 Disc ratchet 3/8" 72 teeth
	7172214	1 Spark plug socket 3/8", 12 pt. 14mm
	7171216...18	3 Spark plug socket 3/8", 16, 18, 21mm
	7142044...200	4 Extension 3/8", 44, 75, 150, 200mm
	71521	1 Universal joint 3/8"
	82414805...12	6 Bit socket hex 3/8", 3/16", 7/32", 1/4", 5/16", 3/8", 7/16"
	8264825...50	6 Bit socket TX 3/8", T25, T27, T30, T40, T45, T50

FOR A COMPLETE INVENTORY ORDER LIST SEE OUR WEBSITE

202302 - 3/8" LONG SOCKET SAE SET, SFS 1/3, 23-PCS



TOOLS	ART. NO.	CONTENTS
	2296310...21	8 Flank deep socket 3/8", 12 pt. 3/8", 7/16", 1/2", 9/16", 5/8", 11/16", 3/4", 13/16"
	7152610...16	4 Cardan socket TX 3/8", E10, E12, E14, E16
	71521	1 Universal joint 3/8"
	2266306...20	10 Deep socket TX 3/8", E6, E7, E8, E10, E11, E12, E14, E16, E18, E20

FOR A COMPLETE INVENTORY ORDER LIST SEE OUR WEBSITE

302005 - 1/2" COMBINATION SAE SET, SFS 1/3, 20-PCS



TOOLS	ART. NO.	CONTENTS
	23910...32	15 Flank socket 1/2", 12 pt. 3/8", 7/16", 1/2", 9/16", 5/8", 11/16", 3/4", 13/16", 7/8", 15/16", 1", 1.1/16", 1.1/8", 1.3/16", 1.1/4"
	7121503	1 Ratchet 1/2" 60 teeth
	7143125...250	2 Extension 1/2", 125, 250mm
	71531	1 Universal joint 1/2"
	71623	1 Adaptor for extension 3/8"(F) x 1/2"(M)

FOR A COMPLETE INVENTORY ORDER LIST SEE OUR WEBSITE

302004 - 1/2" DEEP SOCKET SAE SET, SFS 1/3, 20-PCS

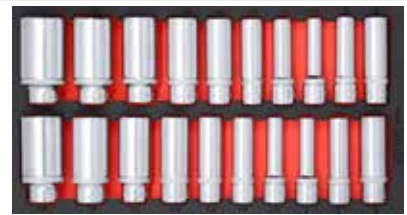

TOOLS	ART. NO.	CONTENTS
	2397710...32	15 Flank deep socket 1/2", 12 pt. 3/8", 7/16", 1/2", 9/16", 5/8", 11/16", 3/4", 13/16", 7/8", 15/16", 1", 1.1/16", 1.1/8", 1.3/16", 1.1/4"
	2367714...22	5 Deep socket TX 1/2", E14, E16, E18, E20, E22

FOR A COMPLETE INVENTORY ORDER LIST SEE OUR WEBSITE

303806 - 1/2" SOCKET BIT SAE SET, SFS 1/3, 38-PCS



TOOLS	ART. NO.	CONTENTS
	23910...32	15 Flank socket 1/2" 12 pt. 3/8", 7/16", 1/2", 9/16", 5/8", 11/16", 3/4", 13/16", 7/8", 15/16", 1", 1.1/16", 1.1/8", 1.3/16", 1.1/4"
	23610...24	8 Socket TX 1/2", E10, E11, E12, E14, E16, E18, E20, E24
	834106205...17	10 Bit socket hex 1/2", 3/16", 1/4", 9/32", 5/16", 11/32", 3/8", 7/16", 1/2", 9/16", 5/8"
	83606245...70	5 Bit socket TX 1/2", T45, T50, T55, T60, T70

FOR A COMPLETE INVENTORY ORDER LIST SEE OUR WEBSITE

601406 - COMBINATION WRENCH SAE SET, SFS 1/3, 14-PCS

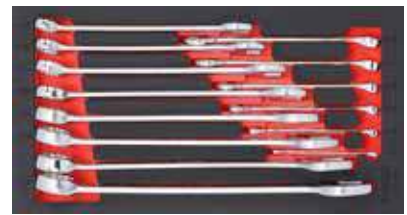

TOOLS	ART. NO.	CONTENTS
	4150206...27	14 Combination wrench 1/4", 5/16", 3/8", 7/16", 1/2", 9/16", 5/8", 11/16", 3/4", 13/16", 7/8", 15/16", 1", 1.1/16"

FOR A COMPLETE INVENTORY ORDER LIST SEE OUR WEBSITE

603506 - SCREWDRIVER SET, SFS, 35-PCS

M

570 X 370MM



TOOLS	ART. NO.	CONTENTS
	1311...13	3 Screwdriver PH, PH.1, PH.2, PH.3
	1311S...2S	2 Screwdriver stubby, PH, PH.1, PH.2
	13303...08	5 Screwdriver slotted, 3, 4, 5.5, 6.5, 8mm
	133055S	1 Screwdriver stubby slotted, 5.5mm
	13606...30	10 Screwdriver TX, T6, T7, T8, T9, T10, T15, T20, T25, T27, T30
	1950205...08	3 Hex ball point grip key 5, 6, 8mm
	17320002	1 Electronic screwdriver 2mm
	601008	10 Hex ball key set extra long 10-pcs, 1.27, 1.5, 2, 2.5, 3, 4, 5, 6, 8, 10mm

FOR A COMPLETE INVENTORY ORDER LIST SEE OUR WEBSITE

602716 - SCREWDRIVER SET, SFS, 27-PCS

M

570 X 370MM



TOOLS	ART. NO.	CONTENTS
	1310...3	4 Screwdriver PH, PH.0, PH.1, PH.2, PH.3
	1312S	1 Screwdriver stubby, PH, PH.2
	13304...08	4 Screwdriver slotted, 4, 5.5, 6.5, 8mm
	133055S	1 Screwdriver stubby slotted, 5.5mm
	13608...40	9 Screwdriver TX, T8, T9, T10, T15, T20, T25, T27, T30, T40
	47536...08	3 Flexible hex nut driver 6, 7, 8mm
	47837...38	3 Precision screwdriver slotted 2.0 x 60, 3.0 x 60
	47839...40	3 Precision screwdriver PH 0 x 60, PH 00 x 60

FOR A COMPLETE INVENTORY ORDER LIST SEE OUR WEBSITE

604102 - SCREWDRIVER SET, SFS, 41-PCS

M

570 X 370MM



TOOLS	ART. NO.	CONTENTS
	1310...3	4 Screwdriver PH, PH.0, PH.1, PH.2, PH.3
	1312S	1 Screwdriver stubby, PH, PH.2
	13304...08	4 Screwdriver slotted, 4, 5.5, 6.5, 8mm
	133055S	1 Screwdriver stubby slotted, 5.5mm
	13608...40	9 Screwdriver TX, T8, T9, T10, T15, T20, T25, T27, T30, T40
	47536...08	3 Flexible hex nut driver 6, 7, 8mm
	600902	9 TX key set extra long, 9-pcs, T10, T15, T20, T25, T27, T30, T40, T45, T50
	600912	9 Hex ball stubby key set 9-pcs, 1.5, 2, 2.5, 3, 4, 5, 6, 8, 10mm
	12425010	1 Hex nut driver 10mm

FOR A COMPLETE INVENTORY ORDER LIST SEE OUR WEBSITE

602708 - SCREWDRIVERS SET, SFS, 27-PCS

M

570 X 370MM



TOOLS	ART. NO.	CONTENTS
	1311...13	3 Screwdriver PH, PH.1, PH.2, PH.3
	1311S	1 Screwdriver stubby, PH, PH.1
	1321...23	3 Screwdriver PZ, PZ.1, PZ.2, PZ.3
	1321S	1 Screwdriver stubby PZ, PZ.1
	13303...08	5 Screwdriver slotted, 3, 4, 5.5, 6.5, 8mm
	133055S	1 Screwdriver stubby slotted, 5.5mm
	13606...40	11 Screwdriver TX, T6, T7, T8, T9, T10, T15, T20, T25, T27, T30, T40
	47536...37	2 Flexible hex nut driver 6, 7mm

FOR A COMPLETE INVENTORY ORDER LIST SEE OUR WEBSITE

602709 - SCREWDRIVERS SET, SFS, 27-PCS

M

570 X 370MM

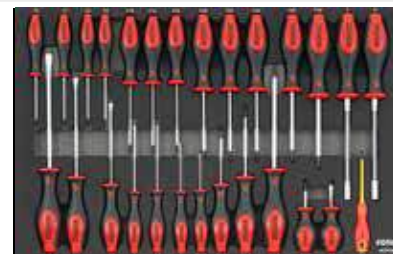

TOOLS	ART. NO.	CONTENTS
	1310...3	4 Screwdriver PH, PH.0, PH.1, PH.2, PH.3
	1312S	1 Screwdriver stubby PH, PH.2
	13303...08	6 Screwdriver slotted, 3, 3.5, 4, 5.5, 6.5, 8mm
	133055S	1 Screwdriver stubby slotted, 5.5mm
	16325	1 VDE scewdriver slotted, 2.5mm
	136...45	12 Screwdriver TX, T6, T7, T8, T9, T10, T15, T20, T25, T27, T30, T40, T45
	47537...38	2 Flexible hex nut driver 7, 8mm

FOR A COMPLETE INVENTORY ORDER LIST SEE OUR WEBSITE

Sonic Foam System (SFS)

602407 - SCREWDRIVER SET, SFS, 24-PCS

M

570 X 370MM

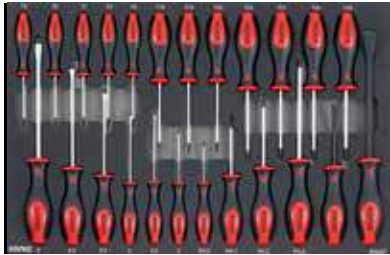

TOOLS	ART. NO.	CONTENTS
	1310...3	4 Screwdriver PH, PH.0, PH.1, PH.2, PH.3
	13303...08	6 Screwdriver slotted, 3, 3.5, 4, 5.5, 6.5, 8mm
	13605...40	12 Screwdriver TX, T5, T6, T7, T8, T9, T10, T15, T20, T25, T27, T30, T40
	- 4821308...12	2 Pry bar 200mm 8", 300mm 12"

FOR A COMPLETE INVENTORY ORDER LIST SEE OUR WEBSITE

601808 - SCREWDRIVER SET, SFS, 18-PCS

M

570 X 370MM

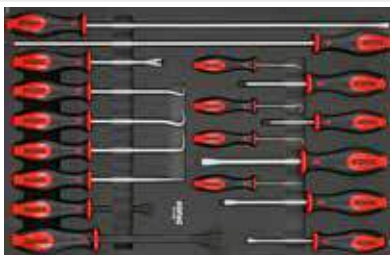

TOOLS	ART. NO.	CONTENTS
	1314502	1 Screwdriver PH, PH.2 450mm
	13345065	1 Screwdriver slotted, 6.5 450mm
	15101...02	2 Hammer screwdriver PH, PH.1, PH.2
	1530155...08	3 Hammer screwdriver slotted, 5.5, 6.5, 8mm
	- 47829	1 Mini straight pick hook
	- 47830	1 Mini degree hook
	- 47831	1 Mini full hook
	- 47832	1 Mini small angle hook
	- 47901	1 Door upholstery panel remover 100mm
	- 47909	1 Straight pick (6x135)
	- 47910	1 Degree hook (6x135)
	- 47911	1 Full hook (6x135)
	- 47912	1 Small angle hook (6x135)
	- 4821308...12	2 Pry bar 200mm 8", 300mm 12"

FOR A COMPLETE INVENTORY ORDER LIST SEE OUR WEBSITE

112102 - COMBINATION SET 1/4", SFS, 121-PCS

M

570 X 370MM



TOOLS	ART. NO.	CONTENTS
	1310...3	4 Screwdriver PH, PH.0, PH.1, PH.2, PH.3
	13303...08	6 Screwdriver slotted, 3, 3.5, 4, 5.5, 6.5, 8mm
	- 4821308	1 Pry bar 200mm 8"
	multi 601001	16 16 in 1 ratchet screwdriver
	21504...13	12 Flank socket 1/4", 6 pt. 4, 4.5, 5, 5.5, 6, 7, 8, 9, 10, 11, 12, 13mm
	2155004...13	12 Flank deep socket 1/4", 6 pt. 4, 4.5, 5, 5.5, 6, 7, 8, 9, 10, 11, 12, 13mm
	21604...10	6 Socket TX 1/4", E4, E5, E6, E7, E8, E10
	2165004...10	6 Deep socket TX 1/4", E4, E5, E6, E7, E8, E10
	8143703...10	7 Bit socket hex 1/4", 3, 4, 5, 6, 7, 8, 10mm
	8153710...40	7 Tamper-resistant 1/4", TX plus (5 lobes) 10IPR, 15IPR, 20IPR, 25IPR, 27IPR, 30IPR, 40IPR
	8163708...40	8 Bit socket TX 1/4", T8, T10, T15, T20, T25, T27, T30, T40
	8173708...40	8 Bit socket TX tamperproof 1/4", T8H, T10H, T15H, T20H, T25H, T27H, T30H, T40H
	600902	9 TX key set extra long, 9-pcs. T15, T20, T25, T27, T30, T40, T45, T50
	601008	10 Hex ball key set extra long 10-pcs, 1.27, 1.5, 2, 2.5, 3, 4, 5, 6, 8, 10mm
	- 7110101	1 Flexible ratchet 1/4", 45 teeth
	- 7110301	1 Disc ratchet 1/4", 72 teeth
	- 7120701	1 Ratchet 1/4" 72 teeth
	- 7121501	1 Ratchet 1/4" 60 teeth
	- 7141050...150	3 Extension 1/4" 50, 100, 150mm
	- 71511	1 Universal joint 1/4"
	- 72225	1 Magnet socket pick-up 1/4"

FOR A COMPLETE INVENTORY ORDER LIST SEE OUR WEBSITE

106105 - COMBINATION SET 1/4" SCREWDRIVER AND WRENCH, SFS, 61-PCS



TOOLS	ART. NO.	CONTENTS
	1311..12	2 Screwdriver PH, PH.1, PH.2
	13303..65	4 Screwdriver slotted, 3, 4, 5.5, 6.5mm
	21503..12	12 Flank socket 1/4", 6 pt. 3, 4, 4.5, 5, 5.5, 6, 7, 8, 9, 10, 11, 12mm
	2155008...13	6 Flank deep socket 1/4", 6 pt. 8, 9, 10, 11, 12, 13mm
	41506...24	18 Combination wrench 6, 7, 8, 9, 10, 11, 12, 13, 14, 15, 16, 17, 18, 19, 20, 21, 22, 24mm
	7110301	1 Disc ratchet 1/4" 72 teeth
	7121501	1 Ratchet 1/4" 60 teeth
	7131115	1 Sliding T-handle 1/4"
	7141050...100	2 Extension 1/4" 50, 100mm
	71511	1 Universal joint 1/4"
	72401	1 Spinner 1/4" 150mm
	8143703...07	6 Bit socket hex 1/4", 3, 4, 5, 5.5, 6, 7mm
	8163710...30	6 Bit socket TX 1/4", T10, T15, T20, T25, T27, T30

FOR A COMPLETE INVENTORY ORDER LIST SEE OUR WEBSITE

602904 - SCREWDRIVER & WRENCH SET, SFS, 29-PCS



TOOLS	ART. NO.	CONTENTS
	1311..2	2 Screwdriver PH, PH.1, PH.2
	13303..08	6 Screwdriver slotted, 3, 3.5, 4, 5.5, 6.5, 8mm
	41506...32	21 Combination wrench 6, 7, 8, 9, 10, 11, 12, 13, 14, 15, 16, 17, 18, 19, 20, 21, 22, 24, 27, 30, 32mm

FOR A COMPLETE INVENTORY ORDER LIST SEE OUR WEBSITE

116901 - SCREWDRIVER & 1/4" BIT SOCKET SET SFS, 169-PCS



TOOLS	ART. NO.	CONTENTS
	21504..13	12 Flank socket 1/4", 6 pt. 4, 4.5, 5, 5.5, 6, 7, 8, 9, 10, 11, 12, 13mm
	2155004...13	12 Flank deep socket 1/4", 6 pt. 4, 4.5, 5, 5.5, 6, 7, 8, 9, 10, 11, 12, 13mm
	21804..13	12 Flank socket 1/4", 12 pt. 4, 4.5, 5, 5.5, 6, 7, 8, 9, 10, 11, 12, 13mm
	2185004...13	12 Flank deep socket 1/4", 12 pt. 4, 4.5, 5, 5.5, 6, 7, 8, 9, 10, 11, 12, 13mm
	21604...10	6 Socket TX 1/4", E4, E5, E6, E7, E8, E10
	2165004...10	6 Deep socket TX 1/4", E4, E5, E6, E7, E8, E10
	8113700...03	4 Bit socket PH 1/4", PH.0, PH.1, PH.2, PH.3
	8123700...03	4 Bit socket PZ 1/4", PZ.0, PZ.1, PZ.2, PZ. 3
	8133704...65	3 Bit socket slotted 1/4", 4, 5.5, 6.5mm
	8143703...10	9 Bit socket hex 1/4", 3, 4, 5, 5.5, 6, 7, 8, 9, 10mm
	8103703...10	9 Bit socket ball hex 1/4", 3, 4, 5, 5.5, 6, 7, 8, 9, 10mm
	8163706...40	11 Bit socket TX 1/4", T6, T7, T8, T9, T10, T15, T20, T25, T27, T30, T40
	81613715...40	6 Bit socket ball TX 1/4", T15, T20, T25, T27, T30, T40
	8173706...40	11 Bit socket TX tamperproof 1/4", T6H, T7H, T8H, T9H, T10H, T15H, T20H, T25H, T27H, T30H, T40H
	8153708...50	10 1/4" Tamper-Res. TX plus 8IPR, 10IPR, 15IPR, 20IPR, 25IPR, 27IPR, 30IPR, 40IPR, 45IPR, 50IPR (5 lobes)
	8183704...10	5 Bit socket spline 1/4", M4, M5, M6, M8, M10
	8193704...10	6 Bit socket ribe 1/4", M4, M5, M6, M7, M8, M10
	72401	1 Spinner 1/4", 150mm
	7141100...250	3 Extension 1/4", 100, 150, 250mm
	7120101	1 Stubby ratchet 1/4" -45 teeth
	7271150	1 Swivel grip handle 1/4"
	7121501	1 Ratchet 1/4", 60 teeth
	7110201	1 Ratchet 1/4", 72 teeth
	72601	1 Speedy T-grip 1/4"
	7110301	1 Disc ratchet 1/4", 72 teeth
	73210525	1 Torques wrench 1/4", 5-25Nm
	7151806...13	8 Cardan socket 1/4" 12 pt. 6, 7, 8, 9, 10, 11, 12, 13mm
	7151605...08	4 Cardan socket TX 1/4", E5, E6, E7, E8
	72225	1 Magnet socket pick-up 1/4"
	71912	1 Adaptor 1/4"(F) x 3/8"(M)
	71921	1 Adaptor 3/8"(F) x 1/4"(M)
	71511	1 Universal joint 1/4"
	7211	1 Flexible extension 1/4"
	71911110	1 1/4" Dr. Universal 2-in-1 SB-Adapter 110mm
	41202	1 Hinged driver 1/4" - 3/8"

FOR A COMPLETE INVENTORY ORDER LIST SEE OUR WEBSITE

Sonic Foam System (SFS)

214301 - COMBINATION SET 1/4", & 3/8" SFS, 143-PCS

M

570 X 370MM

5800 GRAM



TOOLS	ART. NO.	CONTENTS
	21504...13	12 Flank socket 1/4", 6 pt. 4, 4.5, 5, 5.5, 6, 7, 8, 9, 10, 11, 12, 13mm
	2155004...13	12 Flank deep socket 1/4", 6 pt. 4, 4.5, 5, 5.5, 6, 7, 8, 9, 10, 11, 12, 13mm
	2256307...17	11 Flank deep socket 3/8", 7, 8, 9, 10, 11, 12, 13, 14, 15, 16, 17mm
	22507...17	11 Flank socket 3/8", 6 pt. 7, 8, 9, 10, 11, 12, 13, 14, 15, 16, 17mm
	8143703...10	9 Bit socket hex 1/4", 3, 4, 5, 5.5, 6, 7, 8, 9, 10mm
	8103703...10	9 Bit socket ball hex 1/4", 3, 4, 5, 5.5, 6, 7, 8, 9, 10mm
	8163706...40	11 Bit socket TX 1/4", T6, T7, T8, T9, T10, T15, T20, T25, T27, T30, T40
	8173706...40	11 Bit socket TX tamperproof 1/4", T6H, T7H, T8H, T9H, T10H, T15H, T20H, T25H, T27H, T30H, T40H
	8264808...50	10 Bit socket TX 3/8", T8, T10, T15, T20, T25, T27, T30, T40, T45, T50
	8274808...50	10 Bit socket TX tamperproof 3/8", T8H, T10H, T15H, T20H, T25H, T27H, T30H, T40H, T45H, T50H
	8244803...12	10 Bit socket hex 3/8" 3, 4, 5, 5.5, 6, 7, 8, 9, 10, 12mm
	8249003...12	10 Bit socket hex 3/8", 90mml 3, 4, 5, 5.5, 6, 7, 8, 9, 10, 12mm
	- 72402	1 Spinner 1/4", 150mml
	- 7141050	1 Extension 1/4" 50mml
	- 7142075...250	3 Extension 3/8" 75, 150, 250mml
	- 7141100...150	2 Extension 1/4", 100, 150mml
	- 7121501...02	1 Ratchet 1/4", 3/8", 60 teeth
	- 72601...02	1 Speedy T-grip 1/4", 3/8"
	- 73210525	1 Torques wrench 1/4", 5-25Nm
	- 73021050	1 Torques wrench 3/8", 10-50Nm
	- 72225	1 Magnet socket pick-up 1/4"
	- 71511...21	1 Universal joint 1/4", 3/8"
	7172214	1 Spark plug clip socket 3/8", 12 pt. 14mm
	7172216...21	3 Spark plug clip socket 3/8", 16, 18, 21mm
	- 7110301...02	1 Disc ratchet 1/4", 3/8", 72 teeth

FOR A COMPLETE INVENTORY ORDER LIST SEE OUR WEBSITE

305002 - COMBINATION SET 1/2" SFS, 50-PCS

M

570 X 370MM

5766 GRAM



TOOLS	ART. NO.	CONTENTS
	- 4720109	1 Empty tray (108x162x45mm)
	83606220...70	10 Bit socket TX 1/2", T20, T25, T27, T30, T40, T45, T50, T55, T60, T70
	83406205...19	10 Bit socket hex 1/2", 5, 6, 7, 8, 9, 10, 12, 14, 17, 19mm
	23508...32	21 Flank socket 1/2", 6 pt. 8, 10, 11, 12, 13, 14, 15, 16, 17, 18, 19, 20, 21, 22, 23, 24, 25, 27, 28, 30, 32mm
	- 7263050	1 Wobble extension 1/2" 50mml
	- 71531	1 Universal joint 1/2"
	- 7143125...250	2 Extension 1/2" 125, 250mml
	- 7273380	1 Swivel grip handle 1/2" 380mml
	- 7121503	1 Ratchet 1/2" 60 teeth
	- 730340200	1 Torque wrench 1/2", 40-200Nm

FOR A COMPLETE INVENTORY ORDER LIST SEE OUR WEBSITE

206501 - COMBINATION SET 3/8" & 1/2", SFS, 65-PCS

M

570 X 370MM

5846 GRAM



TOOLS	ART. NO.	CONTENTS
	22510...21	12 Flank socket 3/8", 6 pt. 10, 11, 12, 13, 14, 15, 16, 17, 18, 19, 20, 21mm
	2256310...17	6 Flank deep socket 3/8", 6 pt. 10, 13, 14, 15, 16, 17mm
	22607...14	6 Socket TX 3/8", E7, E8, E10, E11, E12, E14
	- 7110302	1 Disc ratchet 3/8" 72 teeth
	- 7121502	1 Ratchet 3/8" 60 teeth
	- 7142075...250	3 Extension 3/8" 75, 150, 250mml
	- 71521	1 Universal joint 3/8"
	7171216...21	2 Spark plug socket 3/8" 16, 21mm
	8244805...10	6 Bit socket hex 3/8", 5, 6, 7, 8, 9, 10mm
	8264820...50	6 Bit socket TX 3/8", T25, T27, T30, T40, T45, T50
	23516...32	11 Flank socket 1/2" 6 pt. 16, 17, 18, 19, 20, 21, 22, 24, 27, 30, 32mm
	2357713...22	5 Flank deep socket 1/2" 6 pt. 13, 15, 17, 19, 22mm
	- 7121503	1 Ratchet 1/2" 60 teeth
	- 7143125...250	2 Extension 1/2" 125, 250mml
	- 71531	1 Universal joint 1/2"
	- 71632	1 Adaptor for extension 1/2"(F) x 3/8"(M)

FOR A COMPLETE INVENTORY ORDER LIST SEE OUR WEBSITE

03

214702 - SOCKET 1/4", 1/2" & WRENCH SET, SFS 130-PCS



TOOLS	ART. NO.	CONTENTS
	21504...13	12 Flank socket 1/4", 6 pt. 4, 4.5, 5, 5.5, 6, 7, 8, 9, 10, 11, 12, 13mm
	21604...10	6 Socket 1/4", TX E4, E5, E6, E7, E8, E10
	8183704...08	4 Bit socket spline 1/4", M4, M5, M6, M8
	8133704...65	3 Bit socket slotted 1/4", 4, 5.5, 6.5mm
	8163706...40	11 Bit socket TX 1/4", T6, T7, T8, T9, T10, T15, T20, T25, T27, T30, T40
	8113700...03	4 Bit socket PH 1/4", PH.0, PH.1, PH.2, PH.3
	8173706...40	11 Bit socket TX tamperproof 1/4", T6H, T7H, T8H, T9H, T10H, T15H, T20H, T25H, T27H, T30H, T40H
	8153708...50	10 1/4" TX Plus Biteinsatz, 8IPR, 10IPR, 15IPR, 20IPR, 25IPR, 27IPR, 30IPR, 40IPR, 45IPR, 50IPR
	8123701...03	3 Bit socket PZ 1/4", PZ.1, PZ.2, PZ.3
	8143703...08	7 Bit socket hex 1/4", 3, 4, 5, 5.5, 6, 7, 8mm
	- 72225	1 Magnet socket pick-up 1/4"
	- 71912	1 Adaptor 1/4"(F) x 3/8"(M)
	- 71921	1 Adaptor 3/8"(F) x 1/4"(M)
	- 71511	1 Universal joint 1/4"
	- 41202	1 Hinged driver 1/4"-3/8"
	- 7141050...150	3 Extension 1/4" 50, 100, 150mmL
	- 7261250	1 Wobble extension 1/4" 250mmL
	- 7121501	1 Ratchet 1/4" 60 teeth
	- 7121101	1 Twister ratchet 1/4"
	- 72402	1 Spinner 1/4" 150mmL
	- 100301-1	1 1/4"DR. drill adaptor
	- 7110301	1 Disc ratchet 1/4", 72 teeth
	22510...19	10 Flank socket 3/8", 6 pt. 10, 11, 12, 13, 14, 15, 16, 17, 18, 19mm
	22608...14	5 Socket 3/8", TX E8, E10, E11, E12, E14
	8284806...12	5 Bit socket spline 3/8", M6, M8, M9, M10, M12
	8294804...12	8 Bit socket rife 3/8", M4, M5, M6, M7, M8, M9, M10, M12
	8264825...60	8 Bit socket TX 3/8", T25, T27, T30, T40, T45, T50, T55, T60
	8244806...12	6 Bit socket hex 3/8", 6, 7, 8, 9, 10, 12mm
	- 71923	1 Adaptor 3/8"(F) x 1/2"(M)
	- 71632	1 Adaptor for extension 1/2"(F) x 3/8"(M)
	8274830...60	6 Bit socket TX tamperproof 3/8", T30H, T40H, T45H, T50H, T60H
	7172216...21	3 Spark plug 3/8" clip socket 16, 18, 21mm
	7172214	1 Spark plug clip socket 12-pt. 3/8" 14mm
	- 71521	1 Universal joint 3/8"
	- 7142075...200	3 Extension 3/8" 75, 150, 200mmL
	- 7110302	1 Disc ratchet 3/8", 72 teeth
	- 7121502	1 Ratchet 3/8" 60 teeth
	- 7121102	1 Twister ratchet 3/8"
	- 7142450	1 Extension 3/8" 450mmL

FOR A COMPLETE INVENTORY ORDER LIST SEE OUR WEBSITE

215702 - COMBINATION SET 1/7", & 3/8", SFS, 157-PCS



TOOLS	ART. NO.	CONTENTS
	21504...13	12 Flank socket 1/4", 6 pt. 4, 4.5, 5, 5.5, 6, 7, 8, 9, 10, 11, 12, 13mm
	2155004...13	12 Flank deep socket 1/4", 6 pt. 4, 4.5, 5, 5.5, 6, 7, 8, 9, 10, 11, 12, 13mm
	21604...10	6 Socket TX 1/4", E4, E5, E6, E7, E8, E10
	2165004...10	6 Deep socket TX 1/4", E4, E5, E6, E7, E8, E10
	601008	10 Hex ball key set extra long 10-pcs, 1.27, 1.5, 2, 2.5, 3, 4, 5, 6, 8, 10mm
	600902	9 TX key set extra long, 9-pcs, T10, T15, T20, T25, T27, T30, T40, T45, T50
	- 7110101	1 Flexible ratchet 1/4", 45 teeth
	- 7110301	1 Disc ratchet 1/4", 72 teeth
	- 7110201	1 Ratchet 1/4" 72 teeth
	- 7121501	1 Ratchet 1/4" 60 teeth
	- 7141050...150	3 Extension 1/4" 50, 100, 150mmL
	- 71511	1 Universal joint 1/4"
	- 72225	1 Magnet socket pick-up 1/4"
	8143703...08	7 Bit socket hex 1/4", 3, 4, 5, 5.5, 6, 7, 8mm
	8153710...40	7 Tamper-Resistant 1/4", TX plus (5 lobes) 10IPR, 15IPR, 20IPR, 25IPR, 27IPR, 30IPR, 40IPR
	8163706...25	8 Bit socket TX 1/4", T6, T7, T8, T9, T10, T15, T20, T25
	8173706...25	8 Bit socket TX tamperproof 1/4", T6H, T7H, T8H, T9H, T10H, T15H, T20H, T25H
	22506...22	17 Flank socket 3/8", 6 pt. 6, 7, 8, 9, 10, 11, 12, 13, 14, 15, 16, 17, 18, 19, 20, 21, 22mm
	22604...14	9 Socket TX 3/8", E4, E5, E6, E7, E8, E10, E11, E12, E14
	- 7110302	1 Disc ratchet 3/8" 72 teeth
	- 7121502	1 Ratchet 3/8" 60 teeth
	- 7142075...250	3 Extension 3/8" 75, 150, 250mmL
	- 71521	1 Universal joint 3/8"
	- 71632	1 Adaptor for extension 1/2"(F) x 3/8"(M)
	7171216...21	3 Spark plug socket 3/8" 16, 18, 21mm
	8244803...10	9 Bit socket hex 3/8", 3, 4, 5, 5.5, 6, 7, 8, 9, 10mm
	8264815...55	9 Bit socket TX 3/8", T15, T20, T25, T27, T30, T40, T45, T50, T55
	8274815...55	9 Bit socket TX tamperproof 3/8", T15H, T20H, T25H, T27H, T30H, T40H, T45H, T50H, T55H

FOR A COMPLETE INVENTORY ORDER LIST SEE OUR WEBSITE

Sonic Foam System (SFS)

316001 - COMBINATION SET 1/4", 3/8" & 1/2", SFS, 160-PCS

M

570 X 370MM



TOOLS	ART. NO.	CONTENTS
	21503...13	13 Flank socket 1/4", 6 pt. 3, 4, 4.5, 5, 5.5, 6, 7, 8, 9, 10, 11, 12, 13mm
	2155005...13	9 Flank deep socket 1/4", 6 pt. 5, 6, 7, 8, 9, 10, 11, 12, 13mm
	22510...21	12 Flank socket 3/8", 6 pt. 10, 11, 12, 13, 14, 15, 16, 17, 18, 19, 20, 21mm
	23508...32	21 Flank socket 1/2", 6 pt. 8, 10, 11, 12, 13, 14, 15, 16, 17, 18, 19, 20, 21, 22, 23, 24, 25, 27, 28, 30, 32mm
	600902	9 TX key set extra long, 9-pcs. T10, T15, T20, T25, T27, T30, T40, T45, T50
	601008	10 Hex ball key set extra long 10-pcs. 1.27, 1.5, 2, 2.5, 3, 4, 5, 6, 8, 10mm
	72401	1 Spinner 1/4" 150mml
	7121501	1 Ratchet 1/4" 60 teeth
	7141050...100	2 Extension 1/4" 50, 100mml
	71511	1 Universal joint 1/4"
	8113701...02	2 Bit socket PH 1/4", PH.1, PH.2
	8143703...10	9 Bit socket hex 1/4", 3, 4, 5, 5.5, 6, 7, 8, 9, 10mm
	8163708...40	8 Bit socket TX 1/4", T8, T10, T15, T20, T25, T27, T30, T40
	8183704...10	5 Bit socket spline 1/4", M4, M5, M6, M8, M10
	7121502	1 Ratchet 3/8" 60 teeth
	7142075...150	2 Extension 3/8" 75, 250mml
	71521	1 Universal joint 3/8"
	72023	1 Bit holder 3/8"(F) x 10mm(F)
	7171216...21	2 Spark plug socket 3/8" 16, 21mm
	7121503	1 Ratchet 1/2" 60 teeth
	7133250	1 Sliding T-handle 1/2"
	7143125...250	2 Extension 1/2" 125, 250mml
	71531	1 Universal joint 1/2"
	72033	1 Bit holder 1/2"(F) x 10mm(F)
	9343004...12	7 Bit hex 10mm, 30mml 4, 5, 6, 7, 8, 10, 12
	9347504...12	7 Bit hex 10mm, 75mml 4, 5, 6, 7, 8, 10, 12
	9363020...60	8 Bit TX 10mm, 30mml T20, T25, T30, T40, T45, T50, T55, T60
	9367520...60	8 Bit TX 10mm, 75mml T20, T25, T30, T40, T45, T50, T55, T60
	9383005...12	5 Bit spline 10mm, 30mml M5, M6, M8, M10, M12
	9387505...12	5 Bit spline 10mm, 75mml M5, M6, M8, M10, M12

FOR A COMPLETE INVENTORY ORDER LIST SEE OUR WEBSITE

310101 - COMBINATION SET 3/8" & 1/2", SFS, 101-PCS

M

570 X 370MM



TOOLS	ART. NO.	CONTENTS
	22506...22	17 Flank socket 3/8", 6 pt. 6, 7, 8, 9, 10, 11, 12, 13, 14, 15, 16, 17, 18, 19, 20, 21, 22mm
	22604...14	9 Socket TX 3/8", E4 E5, E6, E7, E8, E10, E11, E12, E14
	8244803...10	9 Bit socket hex 3/8", 3, 4, 5, 5.5, 6, 7, 8, 9, 10mm
	8264815...55	9 Bit socket TX 3/8", T15, T20, T25, T27, T30, T40, T45, T50, T55
	8274815...55	9 Bit socket TX tamperproof 3/8", T15H, T20H, T25H, T27H, T30H, T40H, T45H, T50H, T55H
	7110302	1 Disc ratchet 3/8", 72 teeth
	7121502	1 Ratchet 3/8" 60 teeth
	7142075...250	3 Extension 3/8" 75, 150, 250mml
	71521	1 Universal joint 3/8"
	71632	1 Adaptor for extension 1/2"(F) x 3/8"(M)
	7171216...21	3 Spark plug socket 3/8" 16, 18, 21mm
	23508...32	24 Flank socket 1/2", 6 pt. 8, 9, 10, 11, 12, 13, 14, 15, 16, 17, 18, 19, 20, 21, 22, 23, 24, 25, 26, 27, 28, 29, 30, 32mm
	23610...24	9 Socket TX 1/2", E10, E11, E12, E14, E16, E18, E20, E22, E24
	7121503	1 Ratchet 1/2" 60 teeth
	7143125...250	2 Extension 1/2", 125, 250mml
	71531	1 Universal joint 1/2"
	71623	1 Adaptor for extension 3/8"(F) x 1/2"(M)

FOR A COMPLETE INVENTORY ORDER LIST SEE OUR WEBSITE

309502 - COMBINATION SET 1/2", SFS, 95-PCS

M

570 X 370MM



TOOLS	ART. NO.	CONTENTS
	23508...32	24 Flank socket 1/2", 6 pt. 8, 9, 10, 11, 12, 13, 14, 15, 16, 17, 18, 19, 20, 21, 22, 23, 24, 25, 26, 27, 28, 29, 30, 32mm
	23610...24	9 Socket TX 1/2", E10, E11, E12, E14, E16, E18, E20, E22, E24
	7121503	1 Ratchet 1/2" 60 teeth
	71623	1 Adaptor for extension 3/8"(F) x 1/2"(M)
	7143125...250	2 Extension 1/2" 125, 250mml
	71531	1 Universal joint 1/2"
	7273380	1 Swivel handle 1/2" 380mml
	83406206...17	8 Bit socket hex 1/2", 6, 7, 8, 9, 10, 12, 14, 17mm
	83410006...17	8 Bit socket hex 1/2", 100mml 6, 7, 8, 9, 10, 12, 14, 17mm
	83606227...70	8 Bit socket TX 1/2", T27, T30, T40, T45, T50, T55, T60, T70
	83610027...70	8 Bit socket TX 1/2", 100mml T27, T30, T40, T45, T50, T55, T60, T70
	83706227...70	8 Bit socket tamperproof 1/2", TX T27H, T30H, T40H, T45H, T50H, T55H, T60H, T70H
	83806205...16	8 Bit socket spline 1/2", M5, M6, M8, M9, M10, M12, M14, M16
	83806216T	1 Bit socket spline 1/2", M16-T
	83906208...14	7 Bit socket ribe 1/2", M8, M9, M10, M11, M12, M13, M14

FOR A COMPLETE INVENTORY ORDER LIST SEE OUR WEBSITE

309507 - COMBINATION SET 1/2", SFS 95-PCS

M

570 X 370MM

11854
GRAM



TOOLS	ART. NO.	CONTENTS
	23510...32	20 Flank socket 1/2", 6 pt. 10, 11, 12, 13, 14, 15, 16, 17, 18, 19, 20, 21, 22, 23, 24, 26, 27, 28, 30, 32mm
	23612...24	7 Socket 1/2", TX E12, E14, E16, E18, E20, E22, E24
	33510...19	10 Impact socket 1/2", 6pt. 10, 11, 12, 13, 14, 15, 16, 17, 18, 19mm
	3398530...36	4 Impact socket 1/2", 12pt. deep 30, 32, 34, 36mm
	3310717...21	3 Wheel socket 1/2", 6pt. 17, 19, 21mm
	- 7273380	1 Swivel grip handle 1/2" 370mmL
	- 7121503	1 Ratchet 1/2" 60 teeth
	- 7143125...250	2 Extension 1/2" 125, 250mmL
	- 71531	1 Universal joint 1/2"
	- 7263050	1 Wobble extension 1/2" 50mmL
	83406206...17	8 Bit socket hex 1/2", 6, 7, 8, 9, 10, 12, 14, 17mm
	83706227...70	8 Bit socket tamperproof 1/2", TX T27H, T30H, T40H, T45H, T50H, T55H, T60H, T70H
	83606227...70	8 Bit socket TX 1/2", T27, T30, T40, T45, T50, T55, T60, T70
	83906208...14	7 Bit socket ribe 1/2", M8, M9, M10, M11, M12, M13, M14
	83806216T	1 Bit socket spline 1/2", M16-T
	83806205...16	8 Bit socket spline 1/2", M5, M6, M8, M9, M10, M12, M14, M16
	86404314...19	3 Bit socket impact hex 1/2", one-piece 14, 17, 19mm
	- 73531	1 Impact universal joint 1/2"
	83805517	1 Bit socket XZN 1/2", M17 55mmL

FOR A COMPLETE INVENTORY ORDER LIST SEE OUR WEBSITE

310501 - COMBINATION SET 1/2", SFS, 105-PCS

M

570 X 370MM

8320
GRAM



TOOLS	ART. NO.	CONTENTS
	- 103101	31 Bit set 1/4", 31-pcs
	23610...24	9 Socket TX 1/2", E10, E11, E12, E14, E16, E18, E20, E22, E24
	- 7273380	1 Swivel grip handle 1/2" 380mmL
	83406205...19	10 Bit socket hex 1/2", 5, 6, 7, 8, 9, 10, 12, 14, 17, 19mm
	83410005...14	7 Bit socket hex 1/2", 100mmL 5, 6, 7, 8, 10, 12, 14mm
	83414010	1 Bit socket hex 1/2", 140mmL 10mm
	83424806	1 Bit socket hex 1/2", 248mmL 6mm
	83606225...70	9 Bit socket TX 1/2", T25, T27, T30, T40, T45, T50, T55, T60, T70
	83610025...70	9 Bit socket TX 1/2", 100mmL T25, T27, T30, T40, T45, T50, T55, T60, T70
	83614070	1 Bit socket TX 1/2", 140mmL T70
	83806205...14	7 Bit socket spline 1/2", M5, M6, M8, M9, M10, M12, M14
	83806216T	1 Bit socket spline 1/2", M16-T
	83810006...14	5 Bit socket spline 1/2", 100mmL M6, M8, M10, M12, M14
	86807818	1 Impact bit socket spline 1/2", 78mmL M18
	83910009	1 Bit socket ribe 1/2", 100mmL M9
	83912011	1 Bit socket ribe 1/2", 120mmL M10-1
	83914010	1 Bit socket ribe 1/2", 140mmL M10
	83924007...8	2 Bit socket ribe 1/2", 240mmL M7, M8
	- 818026-6...12	5 Twist socket 1/4", 6, 8, 10, 11, 12mm
	- 818026-13...21	6 Twist socket 1/2", 13, 14, 15, 17, 19, 21mm

FOR A COMPLETE INVENTORY ORDER LIST SEE OUR WEBSITE

Sonic Foam System (SFS)

311201 - BIT SOCKET SET 1/4", 3/8" & 1/2", SFS 112-PCS

M

570 X 370MM

6188 GRAM



TOOLS	ART. NO.	CONTENTS
	21504...13	12 Flank socket 1/4", 6 pt. 4, 4.5, 5, 5.5, 6, 7, 8, 9, 10, 11, 12, 13mm
	8143703...10	9 Bit socket hex 1/4", 3, 4, 5, 5.5, 6, 7, 8, 9, 10mm
	8163706...40	11 Bit socket TX 1/4", T6, T7, T8, T9, T10, T15, T20, T25, T27, T30, T40
	71511	1 Universal joint 1/4"
	7141050...150	3 Extension 1/4" 50, 100, 150mmL
	72225	1 Magnet socket pick-up 1/4"
	7121501	1 Ratchet 1/4" 60 teeth
	72402	1 Spinner 1/4" 150mml
	7261250	1 Wobble extension 1/4" 250mmL
	22506...19	14 Flank socket 3/8", 6 pt. 6, 7, 8, 9, 10, 11, 12, 13, 14, 15, 16, 17, 18, 19mm
	8244804...12	9 Bit socket hex 3/8", 4, 5, 5.5, 6, 7, 8, 9, 10, 12mm
	71521	1 Universal joint 3/8"
	7121502	1 Ratchet 3/8" 60 teeth
	7142075...200	3 Extension 3/8" 75, 150, 200mmL
	23510...32	20 Flank socket 1/2" 6 pt. 10, 11, 12, 13, 14, 15, 16, 17, 18, 19, 20, 21, 22, 23, 24, 26, 27, 28, 30, 32mm
	71531	1 Universal joint 1/2"
	7121503	1 Ratchet 1/2" 60 teeth
	7143125...250	1 Extension 1/2" 125mmL
	7133250	1 Sliding T handle 1/2"
	601008	10 Hex ball extra long key set 10-pcs, 1.27, 1.5, 2, 2.5, 3, 4, 5, 6, 8, 10mm
	600902	9 TX wrench, extra long key set 9-pcs, T10, T15, T20, T25, T27, T30, T40, T45, T50

FOR A COMPLETE INVENTORY ORDER LIST SEE OUR WEBSITE

313902 - BIT SOCKET SET 1/4", 3/8" & 1/2", SFS, 139-PCS

M

570 X 370MM

8554 GRAM



TOOLS	ART. NO.	CONTENTS
	21505...13	10 Flank socket 1/4", 6 pt. 5, 5.5, 6, 7, 8, 9, 10, 11, 12, 13mm
	2155005...13	10 Flank deep socket 1/4", 6 pt. 5, 5.5, 6, 7, 8, 9, 10, 11, 12, 13mm
	7121501	1 Ratchet 1/4" 60 teeth
	7141050...100	2 Extension 1/4" 50, 100mmL
	71511	1 Universal joint 1/4"
	72401	1 Spinner 1/4" 150mml
	8143703...07	5 Bit socket hex 1/4", 3, 4, 5, 6, 7mm
	8153710...45	8 Tamper-Resistant 1/4", TX plus (5 lobes) 10IPR, 15IPR, 20IPR, 25IPR, 27IPR, 30IPR, 40IPR, 45IPR
	8163706...10	5 Bit socket TX 1/4", T6, T7, T8, T9, T10
	8173706...10	5 Bit socket TX tamperproof 1/4", T6H, T7H, T8H, T9H, T10H
	22508...19	12 Flank socket 3/8", 6 pt. 8, 9, 10, 11, 12, 13, 14, 15, 16, 17, 18, 19mm
	7121502	1 Ratchet 3/8" 60 teeth
	7142075...150	2 Extension 3/8" 75, 150mmL
	71521	1 Universal joint 3/8"
	7171216...21	3 Spark plug socket 3/8" 16, 18, 21mm
	8214802	1 Bit socket PH 3/8", PH.2
	8244805...12	8 Bit socket hex 3/8", 5, 5.5, 6, 7, 8, 9, 10, 12mm
	8264815...50	8 Bit socket TX 3/8", T15, T20, T25, T27, T30, T40, T45, T50
	8274815...50	8 Bit socket TX tamperproof 3/8", T15H, T20H, T25H, T27H, T30H, T40H, T45H, T50H
	8284804...12	7 Bit socket spline 3/8", M4, M5, M6, M8, M9, M10, M12
	23510...32	20 Flank socket 1/2", 6 pt. 10, 11, 12, 13, 14, 15, 16, 17, 18, 19, 20, 21, 22, 23, 24, 26, 27, 28, 30, 32mm
	7121503	1 Ratchet 1/2" 60 teeth
	7143125...250	2 Extension 1/2" 125, 250mmL
	71531	1 Universal joint 1/2"
	71623	1 Adaptor for extension 3/8"(F) x 1/2"(M)
	83406210...17	4 Bit socket hex 1/2", 10, 12, 14, 17mm
	83606255...70	3 Bit socket TX 1/2", T55, T60, T70
	83706255...70	3 Bit socket TX tamperproof 1/2", T55H, T60H, T70H
	83806210...16	4 Bit socket spline 1/2", M10, M12, M14, M16
	83806216T	1 Bit socket spline 1/2", M16-T

FOR A COMPLETE INVENTORY ORDER LIST SEE OUR WEBSITE

03

309302 - SOCKET SET 1/4" 3/8" 1/2", SFS, 93-PCS

M

570 X 370MM



TOOLS	ART. NO.	CONTENTS
	21505...13	9 Flank socket 1/4", 6 pt. 5, 6, 7, 8, 9, 10, 11, 12, 13mm
	2155005...13	9 Flank deep socket 1/4", 6 pt. 5, 6, 7, 8, 9, 10, 11, 12, 13mm
	22514...21	7 Flank socket 3/8", 6 pt. 14, 15, 16, 17, 18, 19, 21mm
	2256314...21	7 Flank deep socket 3/8", 6 pt. 14, 15, 16, 17, 18, 19, 21mm
	23522...32	8 Flank socket 1/2", 6 pt. 22, 23, 24, 26, 27, 28, 30, 32mm
	2357722...32	8 Flank deep socket 1/2", 6 pt. 22, 23, 24, 26, 27, 28, 30, 32mm
	8153715...30	4 Tamper-Resistant 1/4", TX plus (5 lobes) 15IPR, 20IPR, 25IPR, 30IPR
	8264808...45	9 Bit socket TX 3/8", T8, T10, T15, T20, T25, T27, T30, T40, T45
	83406210...19	5 Bit socket hex 1/2", 10, 12, 14, 17, 19mm
	601008	10 Hex ball key set extra long 10-pcs, 1.27, 1.5, 2, 2.5, 3, 4, 5, 6, 8, 10mm
	7110201	1 Rotor ratchet 1/4", 72 teeth
	7110301	1 Disc ratchet 1/4", 72 teeth
	7141050...150	3 Extension 1/4" 50, 100, 150mm
	7110202	1 Rotor ratchet 3/8", 72 teeth
	7110302	1 Disc ratchet 3/8", 72 teeth
	7142044...250	4 Extension 3/8" 44, 75, 150, 250mm
	71522	1 Universal ball joint 3/8"
	71632	1 Adaptor for extension 1/2"(F) x 3/8"(M)
	7110203	1 Rotor ratchet 1/2", 72 teeth
	7143125...250	2 Extension 1/2" 125, 250mm

FOR A COMPLETE INVENTORY ORDER LIST SEE OUR WEBSITE

306402 - BIT SOCKET SET 1/2", SFS, 64-PCS

M

570 X 370MM



TOOLS	ART. NO.	CONTENTS
	83710025...80	10 Bit socket TX tamperproof 1/2", 100mm T25H, T27H, T30H, T40H, T45H, T50H, T55H, T60H, T70H, T80H
	83810005...16T	9 Bit socket spline 1/2", 100mm M5, M6, M8, M9, M10, M12, M14, M16, M16T
	83910005...16	10 Bit socket ribe 1/2", 100mm M5, M6, M7 M8, M9, M10, M12, M13, M14, M16
	83912011	1 Bit socket ribe 1/2", 120mm M10-1
	83410005...17	11 Bit socket hex 1/2", 100mm 5, 6, 7, 8, 9, 10, 11, 12, 13, 14, 17
	83010005...14	10 Bit socket ball hex 1/2", bit 100mm 5, 6, 7, 8, 9, 10, 11, 12, 13, 14
	83610027...100	11 Bit socket TX 1/2", 100mm T27, T30, T40, T45, T50, T55, T60, T70, T80, T90, T100
	817006	1 Alternator bit socket 1/2", T50x110L
	817007	1 Alternator bit socket 1/2", M10x110L

FOR A COMPLETE INVENTORY ORDER LIST SEE OUR WEBSITE

303902 - IMPACT SOCKET SET 1/2", SFS, 39-PCS

M

570 X 370MM



TOOLS	ART. NO.	CONTENTS
	3358510...38	27 Impact deep socket 1/2" 6 pt. 78mm 10, 11, 12, 13, 14, 15, 16, 17, 18, 19, 20, 21, 22, 23, 24, 25, 26, 27, 28, 29, 30, 32, 33, 34, 35, 36, 38
	3310115...22	5 Wheel socket 1/2" 15, 17, 19, 21, 22mm
	3310617	1 Impact socket 1/2", 17mm for Mercedes-Benz
	86404314...19	3 Impact bit socket hex one-piece 1/2" 43L 14, 17, 19mm
	7343075...250	3 Impact extension 1/2", 75, 125, 250mm (ball)

FOR A COMPLETE INVENTORY ORDER LIST SEE OUR WEBSITE

307302 - IMPACT SOCKET SET 3/8" & 1/2", SFS, 73-PCS

M

570 X 370MM



TOOLS	ART. NO.	CONTENTS
	32508...19	10 Impact socket 3/8", 6 pt. 8, 10, 11, 12, 13, 14, 15, 16, 17, 19mm
	3256308...19	9 Impact deep socket 3/8", 6 pt. 8, 10, 11, 12, 13, 14, 16, 17, 19mm
	7342075	1 Impact extension 3/8" 75mm
	73521	1 Impact universal joint 3/8"
	73621	1 Impact adaptor 3/8"(F) x 1/4"(M)
	73623	1 Impact adaptor 3/8"(F) x 1/2"(M)
	73721	1 Bit holder 3/8"(F) x 1/4"(F)
	33508...32	23 Impact socket 1/2", 6 pt. 8, 10, 11, 12, 13, 14, 15, 16, 17, 18, 19, 20, 21, 22, 23, 24, 26, 26, 27 28, 29, 30, 32mm
	3358510...32	20 Impact deep socket 1/2", 6 pt. 10, 11, 12, 13, 14, 15, 16, 17, 18, 19, 20, 21, 22, 23, 24, 27, 28, 29, 30, 32mm
	7343075...250	2 Impact extension 1/2" 75, 125, 250mm
	73531	1 Impact universal joint 1/2"
	73632	1 Impact adaptor 1/2"(F) x 3/8"(M)
	73634	1 Impact adaptor 1/2"(F) x 3/4"(M)

FOR A COMPLETE INVENTORY ORDER LIST SEE OUR WEBSITE

Sonic Foam System (SFS)

403201 - SOCKET SET 3/4" METRIC & SAE, SFS, 32-PCS

M

570 X 370MM



TOOLS	ART. NO.	CONTENTS
	24919...50	14 Socket 3/4", 12 pt. 19, 21, 22, 24, 27, 30, 32, 33, 34, 36, 38, 41, 46, 50mm
	24822...47	14 Socket 3/4", 12 pt. 7/8", 15/16", 1", 1.1/16", 1.1/8", 1.3/16", 1.1/4", 1.5/16", 1.3/8", 1.7/16", 1.1/2", 1.5/8", 1.3/4", 1.7/8"
	7120704	1 Ratchet 3/4" 60 teeth
	7134450	1 Sliding T-handle 3/4"
	7234500	1 Swivel handle 3/4" 500mm
	7184400	1 Lock-in 3/4" extension 400mm

FOR A COMPLETE INVENTORY ORDER LIST SEE OUR WEBSITE

403301 - IMPACT SOCKET SET 3/4", SFS, 33-PCS

M

570 X 370MM



TOOLS	ART. NO.	CONTENTS
	34519...46	15 Impact socket 3/4", 6 pt. 19, 21, 22, 23, 24, 27, 28, 30, 32, 33, 34, 36, 38, 41, 46mm
	3459019...46	14 Impact socket 3/4", 6 pt. deep 90mm 19, 21, 22, 23, 24, 27, 30, 32, 33, 34, 36, 38, 41, 46
	73643	1 Impact adaptor 3/4"[F] x 1/2"[M]
	73645	1 Impact adaptor 3/4"[F] x 1"[M] pin
	7344150	1 Impact extension 3/4" 150mm
	73541	1 Impact universal joint 3/4" (90mm) (ball)

FOR A COMPLETE INVENTORY ORDER LIST SEE OUR WEBSITE

603002 - WRENCH SET, SFS, 30-PCS

M

570 X 370MM



TOOLS	ART. NO.	CONTENTS
	41506...38	30 Combination wrench 6, 7, 8, 9, 10, 11, 12, 13, 14, 15, 16, 17, 18, 19, 20, 21, 22, 23, 24, 25, 26, 27, 28, 29, 30, 32, 33, 34, 36, 38mm

FOR A COMPLETE INVENTORY ORDER LIST SEE OUR WEBSITE

604002 - WRENCH SET, SFS, 40-PCS

M

570 X 370MM



TOOLS	ART. NO.	CONTENTS
	4140607...3032	10 Double open wrench 6x7, 8x9, 10x11, 12x13, 14x15, 16x17, 18x19, 20x22, 24x27, 30x32mm
	41506...32	22 Combination wrench 6, 7, 8, 9, 10, 11, 12, 13, 14, 15, 16, 17, 18, 19, 20, 21, 22, 23, 24, 27, 30, 32mm
	4190607...2022	8 75° offset ring wrench 6x7, 8x9, 10x11, 12x13, 14x15, 16x17, 18x19, 20x22mm

FOR A COMPLETE INVENTORY ORDER LIST SEE OUR WEBSITE

603003 - WRENCH SET, SFS, 30-PCS

M

570 X 370MM



TOOLS	ART. NO.	CONTENTS
	4170208...19	12 Reversible ratcheting wrench 12 pt. 8, 9, 10, 11, 12, 13, 14, 15, 16, 17, 18, 19mm
	4120607...1819	7 Hinged socket wrench 6x7, 8x9, 10x11, 12x13, 14x15, 16x17, 18x19mm
	4110810...2427	7 Flare nut wrench 8x10, 11x13, 12x14, 16x18, 17x19, 19x22, 24x27mm
	4160608...2024	4 TX wrench E6XE8, E10XE12, E14XE18, E20XE24

FOR A COMPLETE INVENTORY ORDER LIST SEE OUR WEBSITE

603701 - WRENCH SET, SFS, 38-PCS

M

570 X 370MM

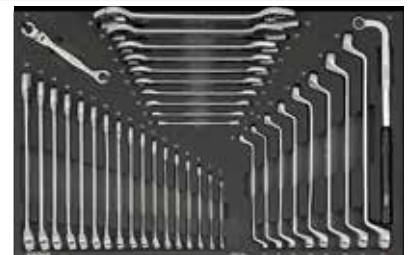

TOOLS	ART. NO.	CONTENTS
	41506...22	17 Combination wrench 6, 7, 8, 9, 10, 11, 12, 13, 14, 15, 16, 17, 18, 19, 20, 21, 22mm
	4140607...3032	10 Double open wrench 6x7, 8x9, 10x11, 12x13, 14x15, 16x17, 18x19, 20x22, 24x27, 30x32mm
	4190607...2022	8 75° offset ring wrench 6x7, 8x9, 10x11, 12x13, 14x15, 16x17, 18x19, 20x22mm
	4200113	1 Injection pump wrench 13mm
	40811	1 Flexible flare nut wrench 11mm
	4821105	1 Flash pen

FOR A COMPLETE INVENTORY ORDER LIST SEE OUR WEBSITE

603903 - WRENCH SET, SFS, 39-PCS

M

570 X 370MM

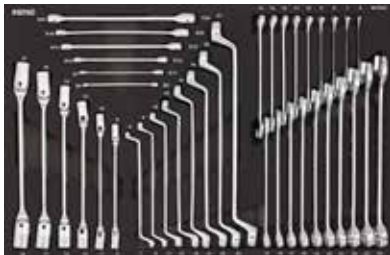

TOOLS	ART. NO.	CONTENTS
	- 41506...24	19 Combination wrench 6, 7, 8, 9, 10, 11, 12, 13, 14, 15, 16, 17, 18, 19, 20, 21, 22, 23, 24mm
	- 4190607...2123	8 75° offset ring wrench 6x7, 8x9, 10x11, 12x13, 14x15, 16x17, 18x19, 21x23mm
	4120809...1819	6 Hinged socket wrench 8x9, 10x11, 12x13, 14x15, 16x17, 18x19mm
	4160608...2024	6 TX wrench E6xE8, E7xE11, E10xE12, E14xE18, E16xE22, E20xE24

FOR A COMPLETE INVENTORY ORDER LIST SEE OUR WEBSITE

604702 - WRENCH SET, SFS, 47-PCS

M

570 X 370MM



TOOLS	ART. NO.	CONTENTS
	- 4110810...3032	8 Flare nut wrench 8x10, 11x13, 12x14, 16x18, 17x19, 19x22, 24x27, 30x32mm
	4120607...1819	7 Hinged socket wrench 6x7, 8x9, 10x11, 12x13, 14x15, 16x17, 18x19mm
	- 4170208...19	12 Reversible ratcheting wrench 12 pt. 8, 9, 10, 11, 12, 13, 14, 15, 16, 17, 18, 19mm
	- 4200607...1819	7 Flat double ring wrench 6x7, 8x9, 10x11, 12x13, 14x15, 16x17, 18x19mm
	- 4211012...1417	3 Half-moon wrench 10x12, 11x13, 14x17mm
	- 42608...17	10 Stubby combination wrench 8, 9, 10, 11, 12, 13, 14, 15, 16, 17mm

FOR A COMPLETE INVENTORY ORDER LIST SEE OUR WEBSITE

604901 - WRENCH SET, SFS, 49-PCS

M

570 X 370MM



TOOLS	ART. NO.	CONTENTS
	- 41506...24	19 Combination wrench 6, 7, 8, 9, 10, 11, 12, 13, 14, 15, 16, 17, 18, 19, 20, 21, 22, 23, 24mm
	4120809...1819	6 Hinged socket wrench 8x9, 10x11, 12x13, 14x15, 16x17, 18x19mm
	4160608...2024	6 TX wrench E6xE8, E7xE11, E10xE12, E14xE18, E16xE22, E20xE24
	- 4170208...19	12 Reversible ratcheting wrench 12 pt. 8, 9, 10, 11, 12, 13, 14, 15, 16, 17, 18, 19mm
	- 4110810...1922	6 Flare nut wrench 8x10, 11x13, 12x14, 16x18, 17x19, 19x22mm

FOR A COMPLETE INVENTORY ORDER LIST SEE OUR WEBSITE

605001 - WRENCH SET, SFS, 50-PCS

M

570 X 370MM



TOOLS	ART. NO.	CONTENTS
	- 40808...12	5 Flexible flare nut wrench 8, 9, 10, 11, 12mm
	- 41202	1 Hinged driver 1/4" - 3/8"
	4120809...1617	5 Hinged socket wrench 8x9, 10x11, 12x13, 14x15, 16x17mm
	41210608...1418	3 Hinged TX wrench E6XE8, E10xE12, E14XE18
	- 4150310...19	10 Combination wrench extra long 10, 11, 12, 13, 14, 15, 16, 17, 18, 19mm
	- 4200607...1819	7 Flat double ring wrench 6x7, 8x9, 10x11, 12x13, 14x15, 16x17, 18x19mm
	600902	9 TX key set extra long, 9-pcs. T10, T15, T20, T25, T27, T30, T40, T45, T50
	601008	10 Hex ball key set extra long 10-pcs, 1.27, 1.5, 2, 2.5, 3, 4, 5, 6, 8, 10mm

FOR A COMPLETE INVENTORY ORDER LIST SEE OUR WEBSITE

605304 - WRENCH SET SFS, 53-PCS

M

570 X 370MM



TOOLS	ART. NO.	CONTENTS
	- 4170208...19	12 Reversible ratcheting wrench 12 pt. 8, 9, 10, 11, 12, 13, 14, 15, 16, 17, 18, 19mm
	- 41506...32	21 Combination wrench 6, 7, 8, 9, 10, 11, 12, 13, 14, 15, 16, 17, 18, 19, 20, 21, 22, 24, 27, 30, 32mm
	600902	9 TX key set extra long, 9-pcs. T10, T15, T20, T25, T27, T30, T40, T45, T50
	601008	10 Hex ball key set extra long 10-pcs, 1.27, 1.5, 2, 2.5, 3, 4, 5, 6, 8, 10mm

FOR A COMPLETE INVENTORY ORDER LIST SEE OUR WEBSITE

Sonic Foam System (SFS)

601404 - PLIERS, CHISEL AND HAMMER SET, SFS, 14-PCS

M

570 X 370MM

2912
GRAM



TOOLS	ART. NO.	CONTENTS
	- 4311175	1 Combination pliers 7"
	- 4321200	1 Long nose pliers 8"
	- 4341175	1 Diagonal pliers 7"
	- 4351250	1 Waterpump pliers 10"
	- 45118190...24220	2 Grip chisel 190mm 18, 220mm 24
	- 4527190	1 Grip cape chisel 190mm 7"
	- 4534180...5200	2 Grip pin punch 180mm 4", 200mm 5"
	- 4552185	1 Grip taper punch 185mm 2"
	- 4611400	1 Machinist hammer with ash handle, 512gr
	- 46806	1 Utility knife (incl. 10 blades)
	- 47013	1 Measuring tape 5 meter
	- 4820110	1 Telescopic magnet

FOR A COMPLETE INVENTORY ORDER LIST SEE OUR WEBSITE

602302 - CHISEL, HAMMER, PLIERS & FILE SET, SFS, 23-PCS

M

570 X 370MM

5894
GRAM



TOOLS	ART. NO.	CONTENTS
	- 4311175	1 Combination pliers 7"
	- 4321200	1 Long nose pliers 8"
	- 4331200	1 Bent long nose pliers 8"
	- 4341175	1 Diagonal pliers 7"
	- 4351250	1 Waterpump pliers 10"
	- 4380250	1 Locking pliers 10"
	- 45118190...24220	2 Grip chisel 190mm 18, 220mm 24
	- 4533150...6210	4 Grip pin punch 150mm 3, 180mm 4, 200mm 5, 210mm 6
	- 4552185...4185	3 Grip taper punch 185mm 2, 3, 4
	- 4611400	1 Machinist hammer with ash handle, 512GR
	- 4631000	1 Stoning hammer with ash handle, 1106gr
	- 47013	1 Measuring tape 5 meter
	- 46806	1 Utility knife (incl. 10 blades)
	- 46911	1 Flat file 8"
	- 46912	1 Half round file 8"
	- 46913	1 Round file 8"
	- 46914	1 Triangular file 8"

FOR A COMPLETE INVENTORY ORDER LIST SEE OUR WEBSITE

601707 - PLIERS, CHISEL AND HAMMER SET, SFS, 12-PCS

M

570 X 370MM

5496
GRAM



TOOLS	ART. NO.	CONTENTS
	- 4311175	1 Combination pliers 7"
	- 4321200	1 Long nose pliers 8"
	- 4331200	1 Bent long nose pliers 8"
	- 4341175	1 Diagonal pliers 7"
	- 4351250	1 Waterpump pliers 10"
	- 4380250	1 Locking pliers 10"
	- 45118190...24220	2 Grip chisel 190mm 18, 220mm 24
	- 4611400	1 Machinist hammer with ash handle, 512gr
	- 4631000	1 Stoning hammer with ash handle, 1106gr
	- 46911	1 Flat file 8"
	- 46912	1 Half round file 8"
	- 46913	1 Round file 8"
	- 46914	1 Triangular file 8"
	- 47013	1 Measuring tape 5 meter
	- 4820110	1 Telescopic magnet
	- 4811254	1 Steel wire brush

FOR A COMPLETE INVENTORY ORDER LIST SEE OUR WEBSITE

602209 - CHISEL, HAMMER & PLIERS SET, SFS, 22-PCS

M

570 X 370MM

5654
GRAM



TOOLS	ART. NO.	CONTENTS
	- 4311175	1 Combination pliers 7"
	- 4321200	1 Long nose pliers 8"
	- 4331200	1 Bent long nose pliers 8"
	- 4341175	1 Diagonal pliers 7"
	- 4351250	1 Waterpump pliers 10"
	- 43611	1 Snap ring pliers (straight-open)
	- 43612	1 Snap ring pliers (straight-close)
	- 43613	1 Snap ring pliers (bent-open)
	- 43614	1 Snap ring pliers (bent-close)
	- 4611400	1 Machinist hammer with ash handle, 512GR
	- 4631000	1 Stoning hammer with ash handle, 1106gr
	- 4380250	1 Locking pliers 10"
	- 45118190...24220	2 Grip chisel 190mm 18, 220mm 24
	- 4533150...6210	4 Grip pin punch 150mm 3", 180mm 4", 200mm 5", 210mm 6"
	- 4552185...4185	3 Grip taper punch 185mm 2", 3", 4"
	- 47013	1 Measuring tape 5 meter

FOR A COMPLETE INVENTORY ORDER LIST SEE OUR WEBSITE

601207 - PLIERS SET, SFS, 12-PCS

M

570 X 370MM

3326
GRAM

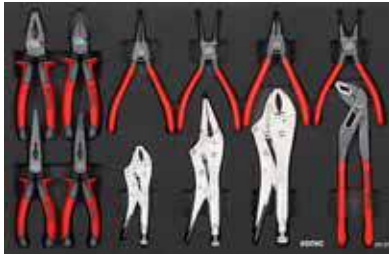

TOOLS	ART. NO.	CONTENTS
	- 4311175	1 Combination pliers 7"
	- 4321200	1 Long nose pliers 8"
	- 4331200	1 Bent long nose pliers 8"
	- 4341175	1 Diagonal pliers 7"
	- 4351250	1 Waterpump pliers 10"
	- 43611	1 Snap ring pliers (straight-open)
	- 43612	1 Snap ring pliers (straight-close)
	- 43613	1 Snap ring pliers (bent-open)
	- 43614	1 Snap ring pliers (bent-close)
	- 4380250	1 Locking pliers 10"
	- 4381225	1 Long nose locking pliers 225mm
	- 4382125	1 Curved jaw locking pliers 125mm

FOR A COMPLETE INVENTORY ORDER LIST SEE OUR WEBSITE

601802 - PLIERS SET, SFS, 18-PCS

M

570 X 370MM

4144
GRAM



TOOLS	ART. NO.	CONTENTS
	- 4311175	1 Combination pliers 7"
	- 4321200	1 Long nose pliers 8"
	- 4331200	1 Bent long nose pliers 8"
	- 4341175	1 Diagonal pliers 7"
	- 4351250	1 Waterpump pliers 10"
	- 43611	1 Snap ring pliers (straight-open)
	- 43612	1 Snap ring pliers (straight-close)
	- 43613	1 Snap ring pliers (bent-open)
	- 43614	1 Snap ring pliers (bent-close)
	- 4380250	1 Locking pliers 10"
	- 46807	1 Utility knife (incl. 13 blades)
	- 46911	1 Flat file 8"
	- 46912	1 Half round file 8"
	- 46913	1 Round file 8"
	- 46914	1 Triangular file 8"
	- 47002	1 Feeler gauge 26-pcs
	- 47003	1 Vernier caliper
	- 47013	1 Measuring tape 5 meter

FOR A COMPLETE INVENTORY ORDER LIST SEE OUR WEBSITE

604207 - PLIERS SET SFS, 42-PCS

M

570 X 370MM

4290
GRAM



TOOLS	ART. NO.	CONTENTS
	- 4311175	1 Combination pliers 7"
	- 4341180	1 Diagonal pliers
	- 4321200	1 Long nose pliers 8"
	- 4331200	1 Bent long nose pliers 8"
	- 4351250	1 Waterpump pliers 10"
	- 43611	1 Snap ring pliers (straight-open)
	- 43612	1 Snap ring pliers (straight-close)
	- 43613	1 Snap ring pliers (bent-open)
	- 43614	1 Snap ring pliers (bent-close)
	- 4380250	1 Locking pliers 10"
	- 47013	1 Measuring tape 5 meter
	- 46806-1	1 10-pcs spare blades dispenser (46806)
	- 46806	1 Utility knife (incl. 10- spare blades)
	- 47003	1 Vernier caliper
	- 47002	1 Feeler gauge 26-pcs
	- 46912	1 Half round file 8"
	- 46913	1 Round file 8"
	- 47004	1 Stainless steel straight ruler 30cm

FOR A COMPLETE INVENTORY ORDER LIST SEE OUR WEBSITE

Sonic Foam System (SFS)

602103 - CHISEL & HAMMER SET, SFS, 21-PCS

M

570 X 370MM

4580
GRAM



TOOLS	ART. NO.	CONTENTS
	- 45118190	1 Grip chisel 190mm 18
	- 45124220	1 Grip chisel 190mm 24
	- 4527190	1 Grip cape chisel 190mm 7
	- 4533150	1 Grip pin punch 150mm 3
	- 4534180	1 Grip pin punch 180mm 4
	- 4535200	1 Grip pin punch 200mm 5
	- 4536210	1 Grip pin punch 210mm 6
	- 4538220	1 Grip pin punch 220mm 8
	- 4552185	1 Grip taper punch 185mm 2
	- 4553185	1 Grip taper punch 185mm 3
	- 4554185	1 Grip taper punch 185mm 4
	- 4564185	1 Grip center punch 185mm 4
	- 4611400	1 Machinist hammer with ash handle, 512gr
	- 4620400	1 Install hammer soft/hard, with ash handle, 608gr
	- 4631000	1 Stoning hammer with ash handle, 1106gr
	- 47903	1 Scraper
	- 4820110	1 Telescopic magnet
	- 4811254	1 Steel wire brush
	- 4821301	1 Wedge universal 190x30mm
	- 48212380	1 Pry bar 380mm
	- 4820207	1 Flexible magnet pickup 500g-400L

FOR A COMPLETE INVENTORY ORDER LIST SEE OUR WEBSITE

601606 - CHISEL & HAMMER SET, SFS, 16-PCS

M

570 X 370MM

4148
GRAM



TOOLS	ART. NO.	CONTENTS
	- 4720107	1 Empty tray (54x110x45mm)
	- 4820516	1 Pocket-sized, ultra-slim work light
	- 45118190	1 Grip chisel 190mm 18
	- 45124220	1 Grip chisel 190mm 24
	- 4533150	1 Grip pin punch 150mm 3
	- 4534180	1 Grip pin punch 180mm 4
	- 4535200	1 Grip pin punch 200mm 5
	- 4536210	1 Grip pin punch 210mm 6
	- 4538220	1 Grip pin punch 220mm 8
	- 4564185	1 Grip center punch 185mm 4
	- 4611400	1 Machinist hammer with ash handle, 512gr
	- 4652035	1 Hammer with nylon tips 610gr. with ash handle
	- 4822102	1 Install hammer soft/hard, with ash handle, 366gr
	- 4811254	1 Steel wire brush
	- 4821301	1 Wedge universal 190x30mm
	- 4820207	1 Flexible magnet pickup 500g-400L

FOR A COMPLETE INVENTORY ORDER LIST SEE OUR WEBSITE

601601 - CHISEL & HAMMER SET, SFS, 16-PCS

M

570 X 370MM

3700
GRAM



TOOLS	ART. NO.	CONTENTS
	- 45110141	1 Grip chisel 140mm 10
	- 45112160	1 Grip chisel 160mm 12
	- 45118190	1 Grip chisel 190mm 18
	- 45124220	1 Grip chisel 220mm 24
	- 4527190	1 Grip cape chisel 190mm 7
	- 4533150	1 Grip pin punch 150mm 3
	- 4534180	1 Grip pin punch 180mm 4
	- 4535200	1 Grip pin punch 200mm 5
	- 4536210	1 Grip pin punch 210mm 6
	- 4552185	1 Grip taper punch 185mm 2
	- 4553185	1 Grip taper punch 185mm 3
	- 4554185	1 Grip taper punch 185mm 4
	- 4564185	1 Grip center punch 185mm 4
	- 4611400	1 Machinist hammer with ash handle, 512gr
	- 4620400	1 Install hammer soft/hard, with ash handle, 608gr
	- 4631000	1 Stoning hammer with ash handle, 1106gr

FOR A COMPLETE INVENTORY ORDER LIST SEE OUR WEBSITE

601706 - CHISEL & HAMMER SET, SFS, 15-PCS



TOOLS	ART. NO.	CONTENTS
	- 45118190	1 Grip chisel 190mml 18
	- 45124220	1 Grip chisel 220mml 24
	- 4527190	1 Grip cape chisel 190mml 7
	- 4533150	1 Grip pin punch 150mml 3
	- 4534180	1 Grip pin punch 180mml 4
	- 4535200	1 Grip pin punch 200mml 5
	- 4536210	1 Grip pin punch 210mml 6
	- 4538220	1 Grip pin punch 220mml 8
	- 4564185	1 Grip center punch 185mml
	- 4611400	1 Machinist hammer with ash handle, 512gr
	- 4620400	1 Install hammer soft/hard, with ash handle, 608gr
	- 47013	1 Measuring tape 5 meter
	- 47019	1 Volt circuit tester
	- 47903	1 Scraper
	- 4811254	1 Steel wire brush
	- 4821301	1 Wedge universal 190x30mm
	- 48212380	1 Pry bar 380mml

FOR A COMPLETE INVENTORY ORDER LIST SEE OUR WEBSITE

602007 - CHISEL & HAMMER SET, SFS, 20-PCS



TOOLS	ART. NO.	CONTENTS
	- 45110141	1 Grip chisel 140mml 10
	- 45112160	1 Grip chisel 160mml 12
	- 45116170	1 Grip chisel 170mml 16
	- 45118190	1 Grip chisel 190mml 18
	- 45124220	1 Grip chisel 220mml 24
	- 4527190	1 Grip cape chisel 190mml 7
	- 4532140	1 Grip pin punch 140mml 2
	- 4533150	1 Grip pin punch 150mml 3
	- 4534180	1 Grip pin punch 180mml 4
	- 4535200	1 Grip pin punch 200mml 5
	- 4536210	1 Grip pin punch 210mml 6
	- 4538220	1 Grip pin punch 220mml 8
	- 4552185	1 Grip taper punch 185mml 2
	- 4553185	1 Grip taper punch 185mml 3
	- 4554185	1 Grip taper punch 185mml 4
	- 4611200	1 Machinist hammer with ash handle, 262gr
	- 4611400	1 Machinist hammer with ash handle, 512gr
	- 4631000	1 Stoning hammer with ash handle, 1106gr
	- 4620400	1 Install hammer soft/hard, with ash handle, 608gr
	- 4822102	1 Install hammer soft/hard, with ash handle, 366gr

FOR A COMPLETE INVENTORY ORDER LIST SEE OUR WEBSITE

Sonic Foam System (SFS)

600928 - HEX NUT DRIVER T-HANDLE SET, SFS, 9-PCS

M

570 X 370MM

1620 GRAM

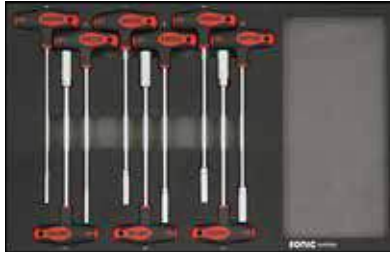

TOOLS	ART. NO.	CONTENTS
	14423005	9 Hex nut driver T-handle 5, 6, 7, 8, 9, 10, 11, 12, 13mm

FOR A COMPLETE INVENTORY ORDER LIST SEE OUR WEBSITE

604402 - UTILITY TOOLS SET, SFS, 44-PCS

M

570 X 370MM

2738 GRAM



TOOLS	ART. NO.	CONTENTS
	- 45602	1 Auto center punch
	- 46602	1 Mini hacksaw
	- 46603	1 Saw blade (3-pcs)
	- 46806	1 Utility knife (incl. 10- spare blades)
	- 46806-1	1 10-pcs spare blades dispenser (46806)
	- 46905	1 Brake caliper file
	- 46911	1 Flat file 8"
	- 46912	1 Half round file 8"
	- 46913	1 Round file 8"
	- 46914	1 Triangular file 8"
	- 47002	1 Feeler gauge 26-pcs
	- 47003	1 Vernier caliper
	- 47004	1 Stainless steel straight ruler 30cm
	- 47005	1 Stainless steel protractor
	- 47013	1 Measuring tape 5 meter
	- 47028	1 Tire profile gauge 50mm
	- 4811254	1 Steel wire brush
	- 48212380	1 Pry bar 380mm
	- 4821301	1 Wedge (190x30mm) universal

FOR A COMPLETE INVENTORY ORDER LIST SEE OUR WEBSITE

602104 - SOCKET SCREWDRIVER, HEX & GRIPS KEY SET, SFS, 21-PCS

M

570 X 370MM

3100 GRAM



TOOLS	ART. NO.	CONTENTS
	12425008...13	9 Hex nut driver 4, 5, 5.5, 6, 9, 10, 11, 12, 13mm
	1950202...12	10 Hex ball point grip key 2, 2.5, 3, 4, 5, 6, 7, 8, 10, 12mm
	47537...38	2 Flexible hex nut driver 7, 8mm

FOR A COMPLETE INVENTORY ORDER LIST SEE OUR WEBSITE

602105 - SOCKET SCREWDRIVER, HEX & GRIP KEY SET, SFS, 21-PCS

M

570 X 370MM

2796 GRAM



TOOLS	ART. NO.	CONTENTS
	12425004...13	9 Hex nut driver 4, 5, 5.5, 6, 9, 10, 11, 12, 13mm
	1960208...50	10 TX grip key T8, T10, T15, T20, T25, T27, T30, T40, T45, T50
	47537...38	2 Flexible hex nut screwdriver 7, 8mm

FOR A COMPLETE INVENTORY ORDER LIST SEE OUR WEBSITE

601806 - HEX BALL GRIP KEY SET, SFS, 18-PCS

M

570 X 370MM

1762 GRAM

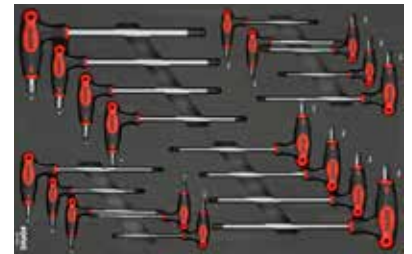

TOOLS	ART. NO.	CONTENTS
	1950202...10	9 Hex ball point grip key 2, 2.5, 3, 4, 5, 6, 7, 8, 10mm
	1960208...45	9 TX grip key T8, T10, T15, T20, T25, T27, T30, T40, T45

FOR A COMPLETE INVENTORY ORDER LIST SEE OUR WEBSITE

310001 - SOCKET SET 1/4", 3/8" & 1/2", 12 PT., SFS, 100-PCS



570 X 370MM



TOOLS	ART. NO.	CONTENTS
	21905...13	9 Socket 1/4", 12 pt. 3/16", 7/32", 1/4", 9/32", 5/16", 11/32", 3/8", 7/16", 1/2"
	2195005...12	9 Socket deep 1/4", 12 pt. 3/16", 7/32", 1/4", 9/32", 5/16", 11/32", 3/8", 7/16", 1/2"
	22910...21	8 Socket 3/8", 12 pt. 3/8", 7/16", 1/2", 9/16", 5/8", 11/16", 3/4", 13/16"
	2296310...21	8 Socket deep 3/8", 12 pt. 3/8", 7/16", 1/2", 9/16", 5/8", 11/16", 3/4", 13/16"
	23910...32	15 Socket 1/2", 12 pt. 3/8", 7/16", 1/2", 9/16", 5/8", 11/16", 3/4", 13/16", 7/8", 15/16", 1", 1.1/16", 1.1/8", 1.3/16", 1.1/4"
	2397710...32	15 Socket 1/2", 12 pt. deep 3/8", 7/16", 1/2", 9/16", 5/8", 11/16", 3/4", 13/16", 7/8", 15/16", 1", 1.1/16", 1.1/8", 1.3/16", 1.1/4"
	81413703...10	7 Bit socket hex 1/4", 1/8", 5/32", 3/16", 7/32", 1/4", 5/16", 3/8"
	82414803...13	9 Bit socket hex 3/8", 1/8", 5/32", 3/16", 7/32", 1/4", 5/16", 3/8", 7/16", 1/2"
	834106205...17	10 Bit socket hex 1/2", 3/16", 1/4", 9/32", 5/16", 11/32", 3/8", 7/16", 1/2", 9/16", 5/8"
	601003	10 Hex key wrench, extra long set 10-pcs, 1/16", 5/64", 3/32", 1/8", 5/32", 3/16", 7/32", 1/4", 5/16", 3/8"

FOR A COMPLETE INVENTORY ORDER LIST SEE OUR WEBSITE

309301 - SOCKET SET 12 PT. 1/4" 3/8" 1/2", SFS, 93-PCS



570 X 370MM



TOOLS	ART. NO.	CONTENTS
	21905...13	9 Socket 1/4", 12 pt. 3/16", 7/32", 1/4", 9/32", 5/16", 11/32", 3/8", 7/16", 1/2"
	2195005...12	9 Deep socket 1/4", 12 pt. 3/16", 7/32", 1/4", 9/32", 5/16", 11/32", 3/8", 7/16", 1/2"
	22910...19	7 Socket 3/8", 12 pt. 3/8", 7/16", 1/2", 9/16", 5/8", 11/16", 3/4"
	2296310...19	7 Deep socket 3/8", 12 pt. 3/8", 7/16", 1/2", 9/16", 5/8", 11/16", 3/4"
	23921...32	8 Socket 1/2", 12 pt. 13/16", 7/8", 15/16", 1", 1.1/16", 1.1/8", 1.3/16", 1.1/4"
	2397721...32	8 Deep socket 1/2", 12 pt. 13/16", 7/8", 15/16", 1", 1.1/16", 1.1/8", 1.3/16", 1.1/4"
	81413703...06	4 Bit socket hex 1/4", 1/8", 5/32", 3/16", 7/32"
	82414803...13	9 Bit socket hex 3/8", 1/8", 5/32", 3/16", 7/32", 1/4", 5/16", 3/8", 7/16", 1/2"
	834106210...17	5 Bit socket hex 1/2", 3/8", 7/16", 1/2", 9/16", 5/8"
	601003	10 Hex key wrench, extra long set 10-pcs, 1/16", 5/64", 3/32", 1/8", 5/32", 3/16", 7/32", 1/4", 5/16", 3/8"
	7110201	1 Rotor ratchet 1/4", 72 teeth
	7110301	1 Disc ratchet 1/4", 72 teeth
	7141050...150	3 Extension 1/4" 50, 100, 150mm
	7110202	1 Rotor ratchet 3/8", 72 teeth
	7110302	1 Disc ratchet 3/8", 72 teeth
	7142044...250	4 Extension 3/8" 44mm, 75mm, 150mm, 250mm
	71522	1 Universal ball joint 3/8"
	71632	1 Adaptor for extension 1/2"(F) x 3/8"(M)
	7110203	1 Rotor ratchet 1/2", 72 teeth
	7143125...250	2 Extension 1/2" 125mm, 250mm
	71531	1 Universal ball joint 1/2"

FOR A COMPLETE INVENTORY ORDER LIST SEE OUR WEBSITE

603101 - WRENCH SET, SFS, 31-PCS



570 X 370MM



TOOLS	ART. NO.	CONTENTS
	4150206...24	12 Combination wrench 1/4", 5/16", 3/8", 7/16", 1/2", 9/16", 5/8", 11/16", 3/4", 13/16", 7/8", 15/16"
	4220608...2932	8 Double open wrench 1/4"x5/16", 3/8"x7/16", 1/2"x9/16", 5/8"x11/16", 11/16"x3/4", 13/16"x7/8", 15/16"x1", 1.1/8"x1.1/4"
	4270608...2425	7 45° offset ring wrench 1/4"x5/16", 3/8"x7/16", 1/2"x9/16", 5/8"x5/8", 11/16"x3/4", 13/16"x7/8", 15/16"x1"
	4250608...1617	4 Flare nut wrench 1/4"x5/16", 3/8"x7/16", 1/2"x9/16", 5/8"x11/16"

FOR A COMPLETE INVENTORY ORDER LIST SEE OUR WEBSITE

602712 - PRY REMOVAL MASTER KIT, SFS 27-PCS



570 X 370MM

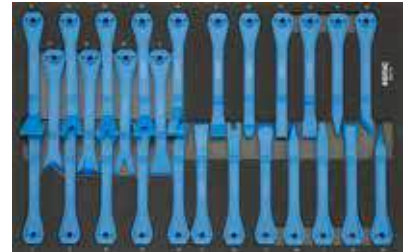

TOOLS	ART. NO.	CONTENTS
	821001-1	1 Wedge 180mm
	821001-2	1 Wedge 180mm
	821001-3	1 Wedge 180mm
	821001-4	1 Wedge 180mm
	821001-5	1 Wedge 180mm
	821001-6	1 Wedge 180mm
	821001-7	1 Wedge 180mm
	821001-8	1 Wedge 180mm
	821001-9	1 Wedge 180mm
	821001-10	1 Wedge 180mm
	821001-11	1 Wedge 180mm
	821001-12	1 Wedge 180mm
	821001-13	1 Wedge 180mm
	821001-14	1 Wedge 180mm
	821001-15	1 Wedge 180mm
	821001-16	1 Wedge 180mm
	821001-17	1 Wedge 180mm
	821001-18	1 Wedge 180mm
	821001-19	1 Wedge 180mm
	821001-20	1 Wedge 180mm
	821001-21	1 Wedge 180mm
	821001-22	1 Wedge 180mm
	821001-23	1 Wedge 180mm
	821001-24	1 Wedge 180mm
	821001-25	1 Wedge 180mm
	821001-26	1 Wedge 180mm
	821001-27	1 Wedge 180mm

FOR A COMPLETE INVENTORY ORDER LIST SEE OUR WEBSITE

Sonic Foam System (SFS)

601907 - ALUMINUM OIL FILTER CUP WRENCH SET, SFS, 19-PCS

M

570 X 370MM



TOOLS	ART. NO.	CONTENTS
	- 601907-1	1 SW100.5mm 15 point: Mazda, Mitsubishi
	- 601907-2	1 SW94.5mm 15 point: Nissan, Toyota
	- 601907-3	1 SW92mm 15 point: Nissan, Subaru
	- 601907-4	1 SW79mm, 15 point: Toyota, Mitsubishi, Subaru, Mazda, Lsuzu
	- 601907-5	1 SW87mm, 16 point: Volvo
	- 601907-6	1 SW79.5mm, 14 point: Lexus
	- 601907-7	1 SW70mm, 14 point: Toyota
	- 601907-8	1 SW63-64mm, 14 point: Toyota
	- 601907-9	1 SW66.5mm, 14 point: Ford, Mazda
	- 601907-10	1 SW84mm, 14 point: 2007 Dodger Sprinter, 2007 Mercedes-Benz E320, 2007 Jeep Cherokee V6 Common rail diesel engines
	- 601907-11	1 27mm: Benz A class
	- 601907-12	1 24mm: BMW 2004 and newer 5.7 Series and X5 with V8 motor (N62) Saturn 2008 Astra with Chrysler 2011 aftr with 3.6L V6 engine, 200, 300 and T/C Dodge Jeep
	- 601907-13	1 30mm: Audi A2, VW Polo, Lupo 1.4L or 1.6L engine
	- 601907-14	1 Adaptor: 1/2" - 3/8"
	- 601907-15	1 Oil filter claw wrench: 55mm - 90mm
	- 601907-16	1 32.5mm: Opel Astra G. Corsa B.Zafira Audi
	- 601907-17	1 38mm: Opel Vectra 2.0D
	- 601907-18	1 35mm: Opel Omega, Vectra B, Zafira (98 on), BMW M43/60, Benz Vito CDI, C and E Class
	- 601907-19	1 SW74mm, 14 point: Mercedes-Benz

FOR A COMPLETE INVENTORY ORDER LIST SEE OUR WEBSITE

47612 - S15 FOAM SPACER, SFS



ART. NO.	CONTENTS
47612	- S15 foam spacer

604302 - BRAKE CALIPER SET, SFS, 43-PCS

M

570 X 370MM



TOOLS	ART. NO.	CONTENTS
	- 809007-1	1 0 Disc
	- 809007-2	1 2 disc
	- 809007-3	1
	- 809007-4	1 4 Disc
	- 809007-5	1 6 Disc
	- 809007-6	1 7 Disc
	- 809007-7	1 8 Disc
	- 809007-8	1 9 Disc
	- 809007-9	1 Holder plate 11
	- 809007-10	1 Holder plate 12
	- 809007-11	1 A Disc
	- 809007-12	1 B disc
	- 809007-13	1 C disc
	- 809007-14	1 D Disc
	- 809007-15	1 E Disc
	- 809007-16	1 F Disc
	- 809007-17	1 G Disc
	- 809007-18	1 6mm 147mm
	- 809007-19	1 7mm 147mm
	- 809007-20	1 J Disc
	- 809007-21	1 K Disc
	- 809007-22	1 K1 Disc
	- 809007-23	1 K2 Disc
	- 809007-24	1 M Disc
	- 809007-25	1 N Disc
	- 809007-26	1 3mm 164mm
	- 809007-27	1 5.5mm 164mm
	- 809007-28	1 P Disc
	- 809007-29	1 R Disc
	- 809007-30	1 S Disc
	- 809007-31	1 Z Disc
	- 809007-32	1 110mm
	- 809007-33	1 Holder plate 0
	- 809007-34	1 Holder plate 1
	- 809007-35	1 5 Disk
	- 830002	1
	- 830003	1
	- 830004	1
	300306-1	1 10mm 56mm
	300306-2	1 14mm 38mm
	300306-3	1 19mm 38mm
	- 805010	1 160mm
	- 805011	1 160mm

FOR A COMPLETE INVENTORY ORDER LIST SEE OUR WEBSITE

603202 - SCREWDRIVER SET, SFS, 32-PCS

L

745 X 435MM

3300 GRAM

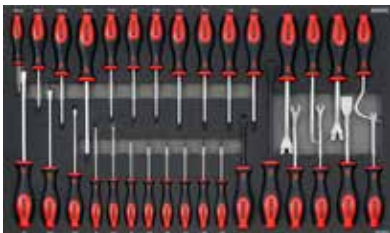

TOOLS	ART. NO.	CONTENTS
	1310...3	4 Screwdriver PH, PH.0, PH.1, PH.2, PH.3
	13303...08	6 Screwdriver slotted, 3, 3.5, 4, 5.5, 6.5, 8mm
	13605...40	12 Screwdriver TX, T5, T6, T7, T8, T9, T10, T15, T20, T25, T27, T30, T40
	- 47901...2	2 Door upholstery panel remover small 100mm, 110mm
	- 47903	1 Scraper
	- 47904	1 Cotter pin puller
	- 47905	1 Radiator hose remover
	- 47906	1 Trim pad tool 1/4" x 115mm
	- 47907	1 Trim pad tool 5/16" x 115mm
	- 47908	1 Door upholstery panel remover 132mm
	- 4821308...12	2 Pry bar 200mm 8", 300mm 12"

FOR A COMPLETE INVENTORY ORDER LIST SEE OUR WEBSITE

603207 - SCREWDRIVER SET, SFS, 32-PCS

L

745 X 435MM

3346 GRAM

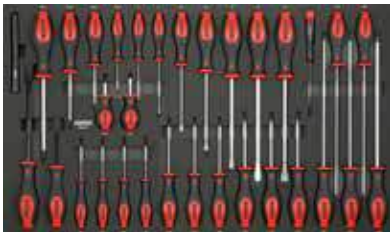

TOOLS	ART. NO.	CONTENTS
	1310...3	5 Screwdriver PH, PH.0, PH.1, PH.2, PH.3
	13303...65	8 Screwdriver slotted, 3, 4, 5.5, 5.5S, 6.5, 8, 10, 12mm
	13606...30	10 Screwdriver TX, T6, T7, T8, T9, T10, T15, T20, T25, T27, T30
	13625015...45	5 Screwdriver TX extra long, 250mm T15, T20, T25, T30, T45
	17320002	1 Electronic screwdriver 2mm
	- 4821105	1 Flash pen
	- 4821308...12	2 Pry bar 200mm 8", 300mm 12"

FOR A COMPLETE INVENTORY ORDER LIST SEE OUR WEBSITE

114602 - SCREWDRIVER & 1/4" BIT SOCKET SET, SFS, 146-PCS

L

745 X 435MM

5070 GRAM

























TOOLS	ART. NO.	CONTENTS
	1310...3	4 Screwdriver PH, PH.0, PH.1, PH.2, PH.3
	1311S	1 Screwdriver stubby PH, PH.1
	13303...08	6 Screwdriver slotted, 3, 3.5, 4, 5.5, 6.5, 8mm
	13305S	1 Screwdriver stubby slotted, 5.5mm
	13605...40	12 Screwdriver TX, T5, T6, T7, T8, T9, T10, T15, T20, T25, T27, T30, T40
	- 47903	1 Scraper
	- 4821312	1 Pry bar 300mm 12"
	- 4821105	1 Flash pen
	21504...13	12 Flank socket 1/4", 6 pt. 4, 4.5, 5, 5.5, 6, 7, 8, 9, 10, 11, 12, 13mm
	2155004...13	12 Flank deep socket 1/4", 6 pt. 4, 4.5, 5, 5.5, 6, 7, 8, 9, 10, 11, 12, 13mm
	21604...10	6 Socket TX 1/4", E4, E5, E6, E7, E8, E10
	2165004...10	6 Deep socket TX 1/4", E4, E5, E6, E7, E8, E10
	- 7110201	1 Rotor ratchet 1/4", 72 teeth
	- 7110301	1 Disc ratchet 1/4", 72 teeth
	- 7121501	1 Ratchet 1/4" 60 teeth
	- 7141050...150	3 Extension 1/4" 50, 100, 150mm
	- 7261250	1 Wobble extension 1/4" 250mm
	- 71511	1 Universal joint 1/4"
	- 71912	1 Adaptor 1/4"(F) x 3/8"(M)
	- 71921	1 Adaptor 3/8"(F) x 1/4"(M)
	- 72225	1 Magnet socket pick-up 1/4"
	- 72401	1 Spinner 1/4" 150mm
	8103703...10	9 Bit socket hex ball 1/4", 3, 4, 5, 5.5, 6, 7, 8, 9, 10mm
	8113700...02	3 Bit socket PH 1/4", PH.0, PH.1, PH.2
	8123700...02	3 Bit socket PZ 1/4", PZ.0, PZ.1, PZ.2
	81337055...065	2 Bit socket slotted 1/4", 5.5, 6.5mm
	8143703...10	9 Bit socket hex 1/4", 3, 4, 5, 5.5, 6, 7, 8, 9, 10mm
	8153708...45	9 Tamper-Resistant 1/4", TX plus (5 lobes) 8IPR, 10IPR, 15IPR, 20IPR, 25IPR, 27IPR, 30IPR, 40IPR, 45IPR
	81613710...40	7 Bit socket TX ball 1/4", T10, T15, T20, T25, T27, T30, T40
	8163706...27	9 Bit socket TX 1/4", T6, T7, T8, T9, T10, T15, T20, T25, T27
	8173707...27	9 Bit socket TX tamperproof 1/4", T7H, T8H, T9H, T10H, T15H, T20H, T25H, T27H
	8183704...10	5 Bit socket spline 1/4", M4, M5, M6, M8, M10
	8193704...10	6 Bit socket ribe 1/4", M4, M5, M6, M7, M8, M10

FOR A COMPLETE INVENTORY ORDER LIST SEE OUR WEBSITE

Sonic Foam System (SFS)

213001 - SOCKET 1/4", 1/2" & WRENCH SET, SFS 130-PCS





























TOOLS	ART. NO.	CONTENTS
	21504...13	12 Flank socket 1/4", 6 pt. 4, 4.5, 5, 5.5, 6, 7, 8, 9, 10, 11, 12, 13mm
	2155004...13	12 Flank deep socket 1/4", 6 pt. 4, 4.5, 5, 5.5, 6, 7, 8, 9, 10, 11, 12, 13mm
	23510...32	20 Flank socket 1/2", 6 pt. 10, 11, 12, 13, 14, 15, 16, 17, 18, 19, 20, 21, 22, 23, 24, 26, 27, 28, 30, 32mm
	2357710...22	5 Flank socket 1/2", 6 pt. deep 10, 13, 17, 19, 22mm
	41506...24	19 Combination wrench 6, 7, 8, 9, 10, 11, 12, 13, 14, 15, 16, 17, 18, 19, 20, 21, 22, 23, 24mm
	601006	10 Hex ball long key set 10-pcs, 1.27, 1.5, 2, 2.5, 3, 4, 5, 6, 8, 10mm
	600902	9 TX wrench, extra long key set 9-pcs, T10, T15, T20, T25, T27, T30, T40, T45, T50
	7110301	1 Disc ratchet 1/4", 72 teeth
	7121501	1 Ratchet 1/4" 60 teeth
	7211	1 Flexible extension 1/4"
	7141050...150	3 Extension 1/4" 50, 100, 150mmL
	71511	1 Universal joint 1/4"
	71623	1 Adaptor for extension 3/8"(F) x 1/2"(M)
	7121503	1 Ratchet 1/2" 60 teeth
	7143125...250	2 Extension 1/2" 125, 250mmL
	71531	1 Universal joint 1/2"
	72402	1 Spinner 1/4" 150mmL
	8113700...02	3 Bit socket PH 1/4", PH.0, PH.1, PH.2
	8123700...02	3 Bit socket PZ 1/4", PZ.0, PZ.1, PZ.2
	8133704...65	3 Bit socket slotted 1/4", 4, 5.5, 6.5mm
	8143703...08	6 Bit socket hex 1/4", 3, 4, 5, 6, 7, 8mm
	8163708...40	8 Bit socket TX 1/4", T8, T10, T15, T20, T25, T27, T30, T40
	8173710...40	7 Bit socket TX tamperproof 1/4", T10H, T15H, T20H, T25H, T27H, T30H, T40H

FOR A COMPLETE INVENTORY ORDER LIST SEE OUR WEBSITE

216401 - SOCKET SET 3/8", SFS, 164-PCS



TOOLS	ART. NO.	CONTENTS
	22506...22	17 Flank socket 3/8", 6 pt. 6, 7, 8, 9, 10, 11, 12, 13, 14, 15, 16, 17, 18, 19, 20, 21, 22mm
	2256306...22	17 Flank deep socket 3/8", 6 pt. 6, 7, 8, 9, 10, 11, 12, 13, 14, 15, 16, 17, 18, 19, 20, 21, 22mm
	22606...20	10 Deep socket TX 3/8", E6, E7, E8, E10, E11, E12, E14, E16, E18, E20
	2266306...20	10 Deep socket TX 3/8", E6, E7, E8, E10, E11, E12, E14, E16, E18, E20
	7110202	1 Rotor ratchet 3/8", 72 teeth
	7121502	1 Ratchet 3/8" 60 teeth
	7142044...250	4 Extension 3/8" 44, 75, 150, 250mmL
	7262044...450	5 Wobble extension 3/8" 44, 150, 200, 300, 450mmL
	71521	1 Universal joint 3/8"
	7152450	1 T-wrench universal joint 3/8", 450mmL
	71632	1 Adaptor for extension 1/2"(F) x 3/8"(M)
	7172214	1 Spark plug clip socket 12 pt. 3/8" 14mm
	7172216...21	3 Spark plug clip socket 3/8", 16, 18, 21mm
	72602	1 Speedy T-grip 3/8"
	7272250	1 Swivel grip handle 3/8" 250mmL
	732210100	1 Torque wrench 3/8" 10-100NM
	8214801...03	3 Bit socket PH 3/8", PH.1, PH.2, PH.3
	8224801...03	3 Bit socket PZ 3/8", PZ.1, PZ.2, PZ.3
	82348055...08	4 Bit socket slotted 3/8", 5.5, 6, 7, 8mm
	8244803...12	10 Bit socket hex 3/8" 3, 4, 5, 5.5, 6, 7, 8, 9, 10, 12mm
	8249004...10	8 Bit socket hex 3/8", 90mmL 4, 5, 5.5, 6, 7, 8, 9, 10mm
	8264808...60	12 Bit socket TX 3/8", T8, T10, T15, T20, T25, T27, T30, T40, T45, T50, T55, T60
	8269010...50	9 Bit socket TX 3/8", 90mmL T10, T15, T20, T25, T27, T30, T40, T45, T50
	8274808...60	12 Bit socket TX tamperproof 3/8", T8H, T10H, T15H, T20H, T25H, T27H, T30H, T40H, T45H, T50H, T55H, T60H
	8284804...12	7 Bit socket spline 3/8", M4, M5, M6, M8, M9, M10, M12
	8289005...12	6 Bit socket spline 3/8", 90mmL M5, M6, M8, M9, M10, M12

FOR A COMPLETE INVENTORY ORDER LIST SEE OUR WEBSITE

218502 - SOCKET COMBINATON SET 1/4" & 3/8", SFS, 185-PCS



745 X 435MM

9480 GRAM



TOOLS	ART. NO.	CONTENTS
	100301-1..2	2 Drill adaptor 3/8", 1/4"
	21504...55	12 Flank socket 1/4", 6 pt. 4, 5, 5.5, 6, 7, 8, 9, 10, 11, 12, 13, 14mm
	21604...10	6 Socket TX 1/4", E4, E5, E6, E7, E8, E10
	7110201	1 Swivel ratchet 1/4" 72 teeth
	7110301	1 Disc ratchet 1/4", 72 teeth
	7121501	1 Ratchet 1/4" 60 teeth
	7141050...150	3 Extension 1/4", 50, 100, 150mm
	71511	1 Universal joint 1/4"
	72225	1 Magnet socket pick-up 1/4"
	72401	1 Spinner 150mm 1/4"
	7261250	1 Wobble extension 1/4", 250mm
	8113701...2	2 Bit socket PH 1/4", bit PH.1, PH.2
	81337055	1 Bit socket slotted 1/4", 5.5mm
	8143703...8	6 Bit socket hex 1/4" 3, 4, 5, 6, 7, 8mm
	8153715...40	6 Tamper-resistant 1/4", TX plus (5 lobes) 15IPR, 20IPR, 25IPR, 27IPR, 30IPR, 40IPR
	8163706...40	11 Bit socket TX 1/4" T6, T7, T8, T9, T10, T15, T20, T25, T27, T30, T40
	9182504...5	2 Bit spline 1/4", 25mm M4, M5
	22506...19	14 Flank socket 3/8", 6 pt. 6, 7, 8, 9, 10, 11, 12, 13, 14, 15, 16, 17, 18, 19mm
	22608...20	8 Socket 3/8", TX E8, E10, E11, E12, E14, E16, E18, E20
	22808...21	12 Flank socket 3/8", 12 pt. 8, 9, 10, 11, 12, 13, 14, 15, 16, 17, 18, 19, 21mm
	2286306...19	14 Flank deep socket 3/8", 12 pt. 6, 7, 8, 9, 10, 11, 12, 13, 14, 15, 16, 17, 18, 19mm
	7110202	1 Flexible ratchet 3/8", 45 teeth
	7110302	1 Disc ratchet 3/8", 72 teeth
	7121502	1 Ratchet 3/8" 60 teeth
	7142044...600	2 Extension 3/8", 44, 600mm
	71521	1 Universal joint 3/8"
	7152810...19	10 Cardan socket 3/8", 12 pt. 10, 11, 12, 13, 14, 15, 16, 17, 18, 19mm
	7172214	1 Spark plug clip socket 12 pt. 3/8" 14mm
	7172216...21	3 Spark plug clip socket 3/8", 16, 18, 21mm
	7262044...450	5 Wobble extension 3/8" 44, 75, 150, 250, 450mm
	7272250	1 Swivel grip handle 3/8", 250mm
	8244805...12	8 Bit socket spline 3/8", 5, 5.5, 6, 7, 8, 9, 10, 12mm
	8264825...60	8 Bit socket TX 3/8", T25, T27, T30, T40, T45, T50, T55, T60
	8284804...12	7 Bit socket spline 3/8" M4, M5, M6, M8, M9, M10, M12
	9283006...10	3 Bit spline 5/16", 30mm M6, M8, M10
	601008	10 Hex ball key set extra long 10-pcs, 1.27, 1.5, 2, 2.5, 3, 4, 5, 6, 8, 10mm
	600902	9 TX key set extra long 9-pcs, T10, T15, T20, T25, T27, T30, T40, T45, T50
	7201001	1 9x12 insert holder for bits 1/4"
	7202001	1 9x12 insert holder for bits 5/16"
	71932	1 Adaptor 1/2"(F) x 3/8"(M)
	71921	1 Adaptor 3/8"(F) x 1/4"(M)
	72032	1 Bit holder 1/2"(F) x 5/16"(F)
	72011	1 Bit holder 1/4"(F) x 1/4"(F)
	41201	1 Hinged driver 1/4" - 1/4" in hex
	41202	1 Hinged driver 1/4" - 3/8"

FOR A COMPLETE INVENTORY ORDER LIST SEE OUR WEBSITE

221201 - SOCKET SET 1/4" & 3/8", SFS, 212-PCS



745 X 435MM

11000 GRAM



TOOLS	ART. NO.	CONTENTS
	21504...13	12 Flank socket 1/4", 6 pt. 4, 4.5, 5, 5.5, 6, 7, 8, 9, 10, 11, 12, 13mm
	2155004...13	12 Flank deep socket 1/4" 6 pt. 4, 4.5, 5, 5.5, 6, 7, 8, 9, 10, 11, 12, 13mm
	21604...10	6 Socket TX 1/4", E4, E5, E6, E7, E8, E10
	2165004...10	6 Deep TX socket 1/4", E4, E5, E6, E7, E8, E10
	8143703...10	7 Bit socket hex 1/4", 3, 4, 5, 6, 7, 8, 10mm
	8113700...02	3 Bit socket PH 1/4", PH.0, PH.1, PH.2
	8123700...02	3 Bit socket PZ 1/4", PZ.0, PZ.1, PZ.2
	8133704...065	3 Bit socket slotted 1/4", 4, 5.5, 6.5mm
	8153710...40	7 Tamper-Resistant 1/4", TX plus (5 lobes) 10IPR, 15IPR, 20IPR, 25IPR, 27IPR, 30IPR, 40IPR
	8163708...40	8 Bit socket TX 1/4", T8, T10, T15, T20, T25, T27, T30, T40
	8173708...40	8 Bit socket TX tamperproof 1/4", T8H, T10H, T15H, T20H, T25H, T27H, T30H, T40H
	7121501	1 Ratchet 1/4" 60 teeth
	7120701	1 Ratchet 1/4" 72 teeth
	7110101	1 Flexible ratchet 1/4", 45 teeth
	7110301	1 Disc ratchet 1/4", 72 teeth
	7141050...150	3 Extension 1/4", 50, 100, 150mm
	71511	1 Universal joint 1/4"
	71921	1 Adaptor 3/8"(F) x 1/4"(M)
	72225	1 Magnet socket pick-up 1/4"
	22506...22	17 Flank socket 3/8", 6 pt. 6, 7, 8, 9, 10, 11, 12, 13, 14, 15, 16, 17, 18, 19, 20, 21, 22mm
	2256306...22	17 Flank deep socket 3/8", 6 pt. 6, 7, 8, 9, 10, 11, 12, 13, 14, 15, 16, 17, 18, 19, 20, 21, 22mm
	22604...16	10 Socket TX 3/8", E4, E5, E6, E7, E8, E10, E11, E12, E14, E16
	2266304...16	10 Deep socket TX 3/8", E4, E5, E6, E7, E8, E10, E11, E12, E14, E16
	8214801...03	3 Bit socket PH 3/8", PH.1, PH.2, PH.3
	8224801...03	3 Bit socket PZ 3/8", PZ.1, PZ.2, PZ.3
	8234805...07	3 Bit socket slotted 3/8", 5.5, 6, 7mm
	8244803...12	10 Bit socket hex 3/8", 3, 4, 5, 5.5, 6, 7, 8, 9, 10, 12mm
	8264808...60	12 Bit socket TX 3/8", T8, T10, T15, T20, T25, T27, T30, T40, T45, T50, T55, T60
	8274808...60	12 Bit socket TX tamperproof 3/8", T8H, T10H, T15H, T20H, T25H, T27H, T30H, T40H, T45H, T50H, T55H, T60H
	8284805...12	6 Bit socket spline 3/8", M5, M6, M8, M9, M10, M12
	8294804...12	8 Bit socket ribe 3/8", M4, M5, M6, M7, M8, M9, M10, M12
	7120102	1 Stubby ratchet 3/8" 45 teeth
	7121502	1 Ratchet 3/8" 60 teeth
	7110102	1 Flexible ratchet 3/8", 45 teeth
	7110302	1 Disc ratchet 3/8", 72 teeth
	732210100	1 Torque wrench 3/8" 10-100Nm
	7142044...250	4 Extension 3/8", 44, 75, 150, 250mm
	71521	1 Universal joint 3/8"
	7152450	1 T-wrench universal joint 3/8", 450mm
	71632	1 Adaptor for extension 1/2"(F) x 3/8"(M)
	7172216...21	3 Spark plug clip socket 3/8", 16, 18, 21mm
	7273250	1 Swivel handle 3/8", 250mm

FOR A COMPLETE INVENTORY ORDER LIST SEE OUR WEBSITE

Sonic Foam System (SFS)

308201 - COMBINATION SET 1/2", SFS, 82-PCS



745 X 435MM



TOOLS	ART. NO.	CONTENTS
	23517...32	10 Flank socket 1/2", 6 pt. 17, 18, 19, 20, 21, 22, 24, 27, 29, 30, 32mm
	23614...24	6 Socket TX 1/2", E14, E16, E18, E20, E22, E24
	23817...32	10 Flank socket 1/2" 12 pt. 17, 18, 19, 20, 21, 22, 24, 27, 29, 30, 32mm
	2387717...32	10 Flank deep socket 1/2", 12 pt. 17, 18, 19, 20, 21, 22, 24, 27, 29, 30, 32mm
	3310117...19	2 Wheel socket 1/2", 17, 19mm
	3398534...36	2 Deep impact socket 1/2", 12 pt. 85mml 34, 36mm
	- 7110203	1 Flexible ratchet 1/2", 72 teeth
	- 7121503	1 Ratchet 1/2" 60 teeth
	- 71531	1 Universal joint 1/2"
	- 71623	1 Adaptor for extension 3/8"(F) x 1/2"(M)
	- 71923	1 Adaptor 3/8"(F) x 1/2"(M)
	- 71934	1 Adaptor 1/2"(F) x 3/4"(M)
	- 71943	1 Adaptor 3/4"(F) x 1/2"(M)
	- 7263050...500	4 Wobble extension 1/2", 50, 125, 250, 500mm
	- 7273380	1 Swivle handle 1/2", 380mml
	83014006...10	4 Bit socket ball hex 1/2", 140mml bit 6, 7, 8, 10mm
	83406208...19	6 Bit socket hex 1/2", 8, 10, 12, 14, 17, 19mm
	83424806	1 Bit socket hex 1/2", 248mml 6
	83606240...70	6 Bit socket TX 1/2", T40, T45, T50, T55, T60, T70
	83805517	1 Bit socket spline 1/2", M17
	83806209...16	5 Bit socket spline 1/2", M9, M10, M12, M14, M16
	83806216T	1 Bit socket spline 1/2", M16T
	83810008...14	3 Bit socket spline 1/2", 100mml M8, M9, M14
	83814010...12	2 Bit socket spline 1/2", 140mml M10, M12
	86807818	1 Impact bit socket spline 1/2", M18

FOR A COMPLETE INVENTORY ORDER LIST SEE OUR WEBSITE

311801 - SOCKET SET 1/2", SFS, 118-PCS



745 X 435MM



TOOLS	ART. NO.	CONTENTS
	23508...32	22 Flank socket 1/2", 6 pt. 8, 9, 10, 11, 12, 13, 14, 15, 16, 17, 18, 19, 20, 21, 22, 23, 24, 26, 27, 28, 30, 32mm
	2357708...32	22 Flank deep socket 1/2", 6 pt. 8, 9, 10, 11, 12, 13, 14, 15, 16, 17, 18, 19, 20, 21, 22, 23, 24, 26, 27, 28, 30, 32mm
	23610...22	8 Socket TX 1/2", E10, E11, E12, E14, E16, E18, E20, E22
	3310117...21	3 Wheel socket 1/2", 6 pt. 17, 19, 21mm
	- 7121503	1 Ratchet 1/2" 60 teeth
	- 7143125...250	2 Extension 1/2" 125, 250mml
	- 71531	1 Universal joint 1/2"
	- 71623	1 Adaptor for extension 3/8"(F) x 1/2"(M)
	- 7273380	1 Swivle grip handle 1/2" 380mml
	- 732320200	1 Torque wrench 1/2" 20-200NM
	83406205...14	8 Bit socket hex 1/2", 5, 6, 7, 8, 9, 10, 12, 14mm
	83410005...14	8 Bit socket hex 1/2", 100mml 5, 6, 7, 8, 9, 10, 12, 14mm
	83606227...70	8 Bit socket TX 1/2", T27, T30, T40, T45, T50, T55, T60, T70
	83610027...70	8 Bit socket TX 1/2", 100mml T27, T30, T40, T45, T50, T55, T60, T70
	83706227...70	8 Bit socket TX tamperproof 1/2", T27H, T30H, T40H, T45H, T50H, T55H, T60H, T70H
	83806205...14	7 Bit socket spline 1/2", M5, M6, M8, M9, M10, M12, M14
	83806216T	1 Bit socket spline 1/2", M16-T
	83906207...16	8 Bit socket ribe 1/2", M7, M8, M9, M10, M12, M13, M14, M16

FOR A COMPLETE INVENTORY ORDER LIST SEE OUR WEBSITE

315601 - COMBINATION SET 1/4", 3/8" & 1/2", SFS, 156-PCS



745 X 435MM



TOOLS	ART. NO.	CONTENTS
	21503...13	13 Flank socket 1/4", 6 pt. 3, 4, 4.5, 5, 5.5, 6, 7, 8, 9, 10, 11, 12, 13mm
	2155005...13	9 Flank deep socket 1/4", 6 pt. 5, 6, 7, 8, 9, 10, 11, 12, 13mm
	8143703...10	7 Bit socket hex 1/4", 3, 4, 5, 6, 7, 8, 10mm
	8113701...03	3 Bit socket PH 1/4", PH.1, PH.2, PH.3
	8123701...03	3 Bit socket PZ 1/4", PZ.1, PZ.2, PZ.3
	8133704...065	3 Bit socket slotted 1/4", 4, 5.5, 6.5mm
	8163708...40	8 Bit socket TX 1/4", T8, T10, T15, T20, T25, T27, T30, T40
	7121501	1 Ratchet 1/4" 60 teeth
	7141050...100	2 Extension 1/4" 50, 100mm
	71511	1 Universal joint 1/4"
	72401	1 Spinner 1/4" 150mm
	22506...22	17 Flank socket 3/8", 6 pt. 6, 7, 8, 9, 10, 11, 12, 13, 14, 15, 16, 17, 18, 19, 20, 21, 22mm
	22604...14	9 Socket TX 3/8", E4, E5, E6, E7, E8, E10, E11, E12, E14
	8244803...10	9 Bit socket hex 3/8", 3, 4, 5, 5.5, 6, 7, 8, 9, 10mm
	8264815...55	9 Bit socket TX 3/8", T15, T20, T25, T27, T30, T40, T45, T50, T55
	8274815...55	9 Bit socket TX tamperproof 3/8", T15H, T20H, T25H, T27H, T30H, T40H, T45H, T50H, T55H
	7121502	1 Ratchet 3/8" 60 teeth
	7171216...21	3 Spark plug socket 3/8" 16, 18, 21mm
	7142075...250	3 Extension 3/8" 75, 150, 250mm
	71521	1 Universal joint 3/8"
	71632	1 Adaptor for extension 1/2"(F) x 3/8"(M)
	7110302	1 Disc ratchet 3/8", 72 teeth
	23508...32	24 Flank socket 1/2", 6 pt. 8, 9, 10, 11, 12, 13, 14, 15, 16, 17, 18, 19, 20, 21, 22, 23, 24, 25, 26, 27, 28, 29, 30, 32mm
	23610...24	9 Socket 1/2", TX E10, E11, E12, E14, E16, E18, E20, E22, E24
	7121503	1 Ratchet 1/2" 60 teeth
	71623	1 Adaptor for extension 3/8"(F) x 1/2"(M)
	7143125...250	2 Extension 1/2" 125, 250mm
	71531	1 Universal joint 1/2"
	3310117...19	3 Wheel socket 1/2", 6 pt. 17, 19, 21mm
	7273380	1 Swivel grip handle 1/2" 380mm

FOR A COMPLETE INVENTORY ORDER LIST SEE OUR WEBSITE

308401 - SOCKET SET, SFS, 84-PCS



745 X 435MM



TOOLS	ART. NO.	CONTENTS
	23508...32	22 Flank socket 1/2", 6 pt. 8, 9, 10, 11, 12, 13, 14, 15, 16, 17, 18, 19, 20, 21, 22, 23, 24, 26, 27, 28, 30, 32mm
	2357708...32	22 Flank deep socket 1/2", 6 pt. 8, 9, 10, 11, 12, 13, 14, 15, 16, 17, 18, 19, 20, 21, 22, 23, 24, 26, 27, 28, 30, 32mm
	23610...24	8 Socket TX 1/2", E10, E11, E12, E14, E16, E18, E20, E24
	2367710...24	8 Deep socket TX 1/2", E10, E11, E12, E14, E16, E18, E20, E24
	83410005...12	6 Bit socket hex 1/2", 100mm 5, 6, 7, 8, 10, 12mm
	83610040...55	4 Bit socket TX 1/2", 100mm T40, T45, T50, T55
	83810006...14	5 Bit socket spline 1/2", 100mm M6, M8, M10, M12, M14
	3310117...21	3 Wheel socket 1/2", 6 pt. 17, 19, 21mm
	732320200	1 Torque wrench 1/2" 20-200NM
	7121503	1 Ratchet 1/2" 60 teeth
	7143125...250	2 Extension 1/2" 125, 250mm
	71531	1 Universal joint 1/2"
	7273380	1 Swivel handle 1/2" 380mm

FOR A COMPLETE INVENTORY ORDER LIST SEE OUR WEBSITE

605101 - WRENCHSET, SFS, 51-PCS



745 X 435MM



TOOLS	ART. NO.	CONTENTS
	4081011	1 Flexible flare nut wrench 10x11mm
	41506...32	21 Combination wrench 6, 7, 8, 10, 11, 12, 13, 14, 15, 16, 17, 18, 19, 20, 21, 22, 24, 27, 30, 32mm
	4160608...2024	6 TX wrench E6XE8, E7xE11, E10XE12, E14XE18, E16XE22, E20XE24
	4170208...19	12 Reversible ratcheting wrench 12 pt. 8, 9, 10, 11, 12, 13, 14, 15, 16, 17, 18, 19mm
	4190607...3032	10 75 offset ring wrench 6X7, 8X9, 10X11, 12X13, 14X15, 16X17, 18X19, 21X22, 24X27, 30X32mm
	4200113	1 Injection pump wrench 13mm

FOR A COMPLETE INVENTORY ORDER LIST SEE OUR WEBSITE

605301 - WRENCH SET, SFS, 53-PCS



745 X 435MM



TOOLS	ART. NO.	CONTENTS
	41506...32	26 Combination wrench 6, 7, 8, 9, 10, 11, 12, 13, 14, 15, 16, 17, 18, 19, 20, 21, 22, 23, 24, 25, 26, 27, 28, 29, 30, 32mm
	4170208...19	12 Reversible ratcheting wrench 12 pt. 8, 9, 10, 11, 12, 13, 14, 15, 16, 17, 18, 19mm
	4190607...2022	8 75° offset ring wrench 6x7, 8x9, 10x11, 12x13, 14x15, 16x17, 18x19, 20x22mm
	4120809...1819	7 Hinged socket wrench 6x7, 8x9, 10x11, 12x13, 14x15, 16x17, 18x19mm

FOR A COMPLETE INVENTORY ORDER LIST SEE OUR WEBSITE

Sonic Foam System (SFS)

604801 - WRENCH SET, SFS, 48-PCS

L
745 X 435MM

6980
GRAM

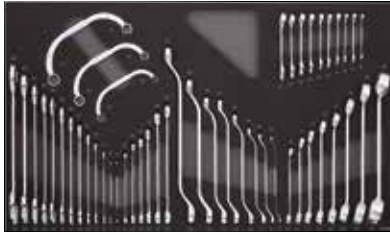

TOOLS	ART. NO.	CONTENTS
	4110810...3032	8 Flare nut wrench 8x10, 11x13, 12x14, 16x18, 17x19, 19x22, 24x27, 30x32mm
	4140607...3032	12 Double open wrench 6x7, 8x9, 10x11, 12x13, 14x15, 16x17, 18x19, 21x23, 20x22, 24x27, 25x28, 30x32mm
	4180607...2123	8 45° offset ring wrench 6X7, 8X9, 10X11, 12X13, 14X15, 16X17, 18X19, 21X23mm
	4200607...1819	7 Flat double ring wrench 6x7, 8x9, 10x11, 12x13, 14x15, 16x17, 18x19mm
	4211012...1417	3 Half-moon wrench 10x12, 11x13, 14x17mm
	42608...17	10 Stubby combination wrench 8, 9, 10, 11, 12, 13, 14, 15, 16, 17mm

FOR A COMPLETE INVENTORY ORDER LIST SEE OUR WEBSITE

606901 - WRENCH SET, SFS, 69-PCS

L
745 X 435MM

7900
GRAM



TOOLS	ART. NO.	CONTENTS
	4110810...3032	8 Flare nut wrench 8x10, 11x13, 12x14, 16x18, 17x19, 19x22, 24x27, 30x32mm
	4140607...3032	12 Double open wrench 6x7, 8x9, 10x11, 12x13, 14x15, 16x17, 18x19, 20x22, 21x23, 24x27, 25x28, 30x32mm
	4170401...02	2 4-in-1 ring ratcheting wrench 8-10, 12-13, 16-17, 18-19mm
	4200607...1819	9 Flat double ring wrench 6x7, 8x9, 10x11, 12x13, 14x15, 16x17, 18x19mm
	4211012...1417	3 Half-moon wrench 10x12, 11x13, 14x17mm
	42608...17	10 Stubby combination wrench 8, 9, 10, 11, 12, 13, 14, 15, 16, 17mm
	41760608...2024	4 TX ratcheting wrench E6xE8, E10XE12, E14XE18, E20XE24
	4160608...2024	4 TX wrench E6xE8, E10XE12, E14XE18, E20XE24
	601007	10 Hex extra long key set 10-pcs, 1,27, 1,5, 2, 2,5, 3, 4, 5, 6, 8, 10mm
	600902	9 TX key set extra long, 9-pcs, T10, T15, T20, T25, T27, T30, T40, T45, T50

FOR A COMPLETE INVENTORY ORDER LIST SEE OUR WEBSITE

602204 - PLIERS & CUTTING SET, SFS, 22-PCS

L
745 X 435MM

4600
GRAM



TOOLS	ART. NO.	CONTENTS
	4321200	1 Long nose pliers 8"
	4331200	1 Bent long nose pliers 8"
	4311175	1 Combination pliers 7"
	4341175	1 Diagonal pliers 7"
	43611	1 Snap ring pliers (straight-open)
	43612	1 Snap ring pliers (straight-close)
	43613	1 Snap ring pliers (bent-open)
	43614	1 Snap ring pliers (bent-close)
	4351250	1 Waterpump pliers 10"
	4380250	1 Locking pliers 10"
	46701	1 Straight shears
	46602	1 Mini hacksaw
	46603	1 Saw blade 3-pcs
	46806	1 Utility knife (incl. 10 blades)
	47004	1 Stainless steel straight ruler 30cm
	47005	1 Stainless steel protractor
	47013	1 Measuring tape 5 meter
	4471250	1 Wire stripper 10"
	4820110	1 Telescopic magnet
	45602	1 Auto center punch
	47002	1 Feeler gauge 26-pcs
	47003	1 Stainless steel vernier caliper

FOR A COMPLETE INVENTORY ORDER LIST SEE OUR WEBSITE

602605 - PLIERS & CUTTING SET, SFS, 26-PCS

L

745 X 435MM

6659
GRAM



TOOLS	ART. NO.	CONTENTS
	- 4311175	1 Combination pliers 7"
	- 4321200	1 Long nose pliers 8"
	- 4323275	1 Long nose pliers 11" straight
	- 4331200	1 Bent long nose pliers 8"
	- 4333270	1 Long nose pliers 11" 90 degree bent
	- 4333275	1 Long nose pliers 11" 45 degree bent
	- 4341175	1 Diagonal pliers 7"
	- 4351250	1 Waterpump pliers 10"
	- 43611	1 Snap ring pliers (straight-open)
	- 43612	1 Snap ring pliers (straight-close)
	- 43613	1 Snap ring pliers (bent-open)
	- 43614	1 Snap ring pliers (bent-close)
	- 4380250	1 Locking pliers 10"
	- 4393002	1 Circle nose pliers 11"-1/2"
	- 4471250	1 Wire stripper 10"
	- 46601	1 Super heavy duty hacksaw
	- 46701	1 Straight shears
	- 46807	1 Utility knife (incl. 13 blades)
	- 47002	1 Feeler gauge 26-pcs
	- 47003	1 Vernier caliper
	- 47004	1 Stainless steel straight ruler 30cm
	- 47013	1 Measuring tape 5 meter
	- 4820110	1 Telescopic magnet
	- 48212380	1 Pry bar 380mml
	- 4811254	1 Steel wire brush
	- 4821301	1 Wedge (190x30mm) universal

FOR A COMPLETE INVENTORY ORDER LIST SEE OUR WEBSITE

602308 - PLIERS, CHISEL AND HAMMER SET, SFS, 23-PCS

L

745 X 435MM

4554
GRAM



TOOLS	ART. NO.	CONTENTS
	14423008...13	3 Hex nut driver T-handle 8, 10, 13mm
	1950205...08	3 Hex ball point grip key 5, 6, 8mm
	- 4311175	1 Combination pliers 7"
	- 4321200	1 Long nose pliers 8"
	- 4322160	1 Long nose pliers
	- 4331200	1 Bent long nose pliers 8"
	- 4333275	1 Long nose pliers 11" 45 degree bent
	- 4341180	1 Diagonal pliers
	- 4351250	1 Waterpump pliers 10"
	- 43611	1 Snap ring pliers (straight-open)
	- 43612	1 Snap ring pliers (straight-close)
	- 43613	1 Snap ring pliers (bent-open)
	- 43614	1 Snap ring pliers (bent-close)
	- 4380250	1 Locking pliers 10"
	- 4471180	1 Wire stripper 7"
	- 47902	1 Door upholstery panel remover 110mml
	- 47904	1 Cotter pin puller
	- 47905	1 Radiator hose remover
	- 47907	1 Trim pad tool 5/16"x115mml

FOR A COMPLETE INVENTORY ORDER LIST SEE OUR WEBSITE

Sonic Foam System (SFS)

604001 - CHISEL, HAMMER & IMPACT SET, SFS, 40-PCS

L
745 X 435MM

9960
GRAM



TOOLS	ART. NO.	CONTENTS
	3358510...32	22 Deep impact socket 1/2", 6 pt. 10, 11, 12, 13, 14, 15, 16, 17, 18, 19, 20, 21, 22, 23, 24, 25, 26, 27, 28, 29, 30, 32mm
	- 45110141	1 Grip chisel 140mml 10
	- 45112160	1 Grip chisel 160mml 12
	- 45118190	1 Grip chisel 190mml 18
	- 45124220	1 Grip chisel 220mml 24
	- 4527190	1 Grip cape chisel 190mml 7
	- 4533150	1 Grip pin punch 150mml 3
	- 4534180	1 Grip pin punch 180mml 4
	- 4535200	1 Grip pin punch 200mml 5
	- 4536210	1 Grip pin punch 210mml 6
	- 4552185	1 Grip taper punch 185mml 2
	- 4553185	1 Grip taper punch 185mml 3
	- 4554185	1 Grip taper punch 185mml 4
	- 4564185	1 Grip center punch 185mml 4
	- 4611400	1 Machinist hammer with ash handle, 512gr
	- 4631000	1 Stoning hammer with ash handle, 1106gr
	- 4620400	1 Install hammer soft/hard, with ash handle, 608gr
	- 7343125	1 Impact extension 1/2" 125mml
	- 73531	1 Impact universal joint 1/2"

FOR A COMPLETE INVENTORY ORDER LIST SEE OUR WEBSITE

602710 - PLIERS AND CHISEL SET, SFS, 27-PCS

L
745 X 435MM

5186
GRAM



TOOLS	ART. NO.	CONTENTS
	- 45118190	1 Grip chisel 190mml 18
	- 45124220	1 Grip chisel 220mml 24
	- 4533150	1 Grip pin punch 150mml 3
	- 4534180	1 Grip pin punch 180mml 4
	- 4535200	1 Grip pin punch 200mml 5
	- 4536210	1 Grip pin punch 210mml 6
	- 4538220	1 Grip pin punch 220mml 8
	- 4564185	1 Grip center punch 185mml 4
	- 4611400	1 Machinist hammer with ash handle, 512gr
	- 46807	1 Utility knife (incl. 13 blades)
	- 46807-1	1 Spare blades dispenser 10-pcs (46807)
	- 46905	1 Brake caliper file
	- 46912	1 Half round file 8"
	- 46913	1 Round file 8"
	- 46914	1 Triangular file 8"
	- 47003	1 Vernier caliper
	- 47006	1 Feeler gauge 20-pcs, 0.05-1.00mm
	- 47013	1 Measuring tape 5 meter
	- 47023	1 Brake fluid tester
	- 47028	1 Tire profile gauge 50mm
	- 47903	1 Scraper
	- 4811254	1 Steel wire brush
	- 4820110	1 Magnet pickup
	- 4820111	1 Telescopic mirror 31-61cm
	- 4821301	1 Wedge (190x30mm) universal
	- 4822102	1 Install hammer soft/hard, with ash handle, 366gr
	- 48222500	1 Pry bar with plastic cover 500mml

FOR A COMPLETE INVENTORY ORDER LIST SEE OUR WEBSITE

03

604202 - HEX NUT & KEY GRIP SET, SFS, 42-PCS

L

745 X 435MM

3940 GRAM



TOOLS	ART. NO.	CONTENTS
	12425004...13	10 Hex nut driver 4, 5, 5.5, 6, 8, 9, 10, 11, 12, 13mm
	47537	1 Flexible hex nut driver 7mm
	1950202...08	8 Hex ball point grip key 2, 2.5, 3, 4, 5, 6, 7, 8mm
	- 46911	1 Flat file 8"
	- 46912	1 Half round file 8"
	- 46913	1 Round file 8"
	- 46914	1 Triangular file 8"
	600902	9 TX key set extra long, 9-pcs, T10, T15, T20, T25, T27, T30, T40, T45, T50
	601008	10 Hex ball key set extra long 10-pcs, 1,27, 1.5, 2, 2.5, 3, 4, 5, 6, 8, 10mm

FOR A COMPLETE INVENTORY ORDER LIST SEE OUR WEBSITE

602803 - HEX NUT & KEY GRIP SET, SFS, 27-PCS

L

745 X 435MM

4280 GRAM

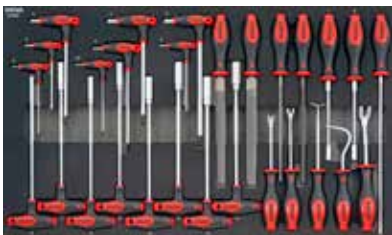

TOOLS	ART. NO.	CONTENTS
	14423006...13	8 Hex nut driver T-handle 6, 7, 8, 9, 10, 11, 12, 13mm
	47537...38	2 Flexible hex nut driver 7, 8mm
	1950202...8	8 Hex ball point grip key 2, 2.5, 3, 4, 5, 6, 7, 8mm
	- 46911	1 Flat file 8"
	- 46912	1 Half round file 8"
	- 46913	1 Round file 8"
	- 46914	1 Triangular file 8"
	- 47901	1 Door upholstery panel remover 100mml
	- 47902	1 Door upholstery panel remover 110mml
	- 47904	1 Cotter pin puller
	- 47905	1 Radiator hose remover
	- 47906	1 Trim pad tool 1/4" x 115mml
	- 4820207	1 Flexible magnet pickup 500g

FOR A COMPLETE INVENTORY ORDER LIST SEE OUR WEBSITE

602411 - VDE TOOLS KITS SET, SFS, 24-PCS

L

745 X 435MM

3628 GRAM



TOOLS	ART. NO.	CONTENTS
	- 4611400	1 Machinist hammer with ash handle, 512gr
	47016	1 Electric main tester 120-250
	1610...2	3 VDE screwdriver PH, PH.0, PH.1, PH.2
	16325...65	4 VDE screwdriver slotted, 2.5, 4, 5.5, 6.5mm
	- 4813908...17	1 VDE socket 3/8", 8-17mm
	- 4813902	1 VDE adaptor 3/8", 125mml
	- 4813901	1 VDE ratchet 3/8"
	- 4312180	1 VDE combination pliers
	- 4322200	1 VDE long nose pliers
	- 4342160	1 VDE diagonal pliers
	- 4472160	1 VDE stripping pliers

FOR A COMPLETE INVENTORY ORDER LIST SEE OUR WEBSITE

47309 - S14 FOAM SPACER, SFS

102 GRAM



ART. NO.	CONTENTS
47309	- S14 foam spacer 750 x 145mm

Sonic Foam System (SFS)

114101 - SCREWDRIVER & 1/4" BIT SOCKET SET, SFS, 141-PCS



TOOLS	ART. NO.	CONTENTS
	1310...3	4 Screwdriver PH, PH.0, PH.1, PH.2, PH.3
	13303...10	7 Screwdriver slotted, 3, 3.5, 4, 5.5, 6.5, 8, 10mm
	13605...40	12 Screwdriver TX, T5, T6, T7, T8, T9, T10, T15, T20, T25, T37, T30, T40
	- 47902	1 Door upholstery panel remover 110mm
	- 47903	1 Scraper
	- 47904	1 Cotter pin puller
	- 47905	1 Radiator hose remover
	- 47906	1 Trim pad tool 1/4"x115mm
	- 47907	1 Trim pad tool 5/16"x115mm
	- 47908	1 Door upholstery panel remover 132mm
	- 47833	2 Straight removal tool 3X63mm, 3X133mm
	- 47835	2 Angle removal tool 3X63mm, 3X133mm
	21504...13	12 Flank socket 1/4", 6 pt. 4, 4.5, 5, 5.5, 6, 7, 8, 9, 10, 11, 12, 13mm
	2155004...13	12 Flank deep socket 1/4", 6 pt. 4, 4.5, 5, 5.5, 6, 7, 8, 9, 10, 11, 12, 13mm
	21604...10	6 Socket TX 1/4", E4, E5, E6, E7, E8, E10
	2165004...10	6 Deep socket TX 1/4", E4, E5, E6, E7, E8, E10
	- 7121501	1 Ratchet 1/4" 60 teeth
	- 7110101	1 Flexible ratchet 1/4", 45 teeth
	- 7110301	1 Disc ratchet 1/4", 72 teeth
	- 7110201	1 Ratchet 1/4" 72 teeth
	- 7191110	1 Universal 2-in-1 SB-Adapter 1/4", 110mm
	- 7271150	1 Swivel grip handle 1/4"
	- 72401	1 Spinner 1/4" 150mm
	- 7141050...150	3 Extension 1/4", 50, 100, 150mm
	- 7261250	1 Wobble extension 1/4", 250mm
	- 71511	1 Universal joint 1/4"
	- 71921	1 Adaptor 3/8"(F) x 1/4"(M)
	- 71912	1 Adaptor 1/4"(F) x 3/8"(M)
	- 7211	1 Flexible extension 1/4"
	- 72225	1 Magnet socket pick-up 1/4"
	8113700...02	3 Bit socket PH 1/4", PH.0, PH.1, PH.2
	8123700...02	3 Bit socket PZ 1/4", PZ.0, PZ.1, PZ.2
	81337055...65	2 Bit socket slotted 1/4", 5.5, 6.5mm
	8143703...10	9 Bit socket hex 1/4", 3, 4, 5, 5.5, 6, 7, 8, 9, 10mm
	8153708...45	9 Tamper-Res.TX plus (5 lobes) 1/4", 8IPR, 10IPR, 15IPR, 20IPR, 25IPR, 27IPR, 30IPR, 40IPR, 45IPR
	8163708...40	9 Bit socket TX 1/4", T8, T9, T10, T15, T20, T25, T27, T30, T40
	8173708...40	9 Bit socket TX tamperproof 1/4", T8H, T10H, T15H, T20H, T25H, T27H, T30H, T40H
	8183704...10	5 Bit socket spline 1/4", M4, M5, M6, M8, M10
	8193704...10	6 Bit socket ribe 1/4", M4, M5, M6, M7, M8, M10

FOR A COMPLETE INVENTORY ORDER LIST SEE OUR WEBSITE

221801 - COMBINATINATION SET 3/8", SFS, 218-PCS



TOOLS	ART. NO.	CONTENTS
	22506...22	17 Flank socket 3/8", 6 pt. 6, 7, 8, 9, 10, 11, 12, 13, 14, 15, 16, 17, 18, 19, 20, 21, 22mm
	2256306...22	17 Flank deep socket 3/8", 6, 7, 8, 9, 10, 11, 12, 13, 14, 15, 16, 17, 18, 19, 20, 21, 22mm
	22806...22	17 Flank socket 3/8", 12 pt. 6, 7, 8, 9, 10, 11, 12, 13, 14, 15, 16, 17, 18, 19, 20, 21, 22mm
	2286306...22	17 Flank deep socket 3/8", 12 pt. 6, 7, 8, 9, 10, 11, 12, 13, 14, 15, 16, 17, 18, 19, 20, 21, 22mm
	22606...20	10 Socket TX 3/8", E6, E7, E8, E10, E11, E12, E14, E16, E18, E20
	2266306...20	10 Deep socket TX 3/8", E6, E7, E8, E10, E11, E12, E14, E16, E18, E20
	- 7121502	1 Ratchet 3/8" 60 teeth
	- 7120102	1 Stubby ratchet 3/8" 45 teeth
	- 7110302	1 Disc ratchet 3/8" 72 teeth
	- 7110202	1 Flexible ratchet 3/8" 72 teeth
	- 7142044...600	6 Extension 3/8" 44, 75, 150, 200, 450, 600mm
	- 71521	1 Universal joint 3/8"
	- 71923	1 Adaptor 3/8"(F) x 1/2"(M)
	- 71932	1 Adaptor 1/2"(F) x 3/8"(M)
	- 7272250	1 Swivel grip handle 3/8" 250mm
	- 72602	1 Speedy T-grip 3/8"
	- 7152450	1 T-wrench universal joint 3/8" 450mm
	7172214	1 Spark plug clip socket 12 pt. 3/8", 14mm
	7172216...21	3 Spark plug clip socket 3/8", 16, 18, 21mm
	- 732210100	1 Torques wrench 3/8", 10-100NM
	8214801...3	3 Bit socket PH 3/8", PH.1, PH.2, PH.3
	8224801...3	3 Bit socket PZ 3/8", PZ.1, PZ.2, PZ.3
	8244803...12	11 Bit socket hex 3/8", 3, 4, 5, 5.5, 6, 7, 8, 9, 10, 11, 12mm
	8249003...11	9 Bit socket hex 3/8", 90mm 3, 4, 5, 6, 7, 8, 9, 10, 11mm
	8209003...11	9 Bit socket ball hex 3/8", 90mm 3, 4, 5, 6, 7, 8, 9, 10, 11mm
	8264808...60	12 Bit socket TX 3/8", T8, T10, T15, T20, T25, T27, T30, T40, T45, T50, T55, T60
	8269008...50	10 Bit socket TX 3/8", 90mm T8, T10, T15, T20, T25, T27, T30, T40, T45, T50
	8274808...60	12 Bit socket TX tamperproof 3/8", T8H, T10H, T15H, T20H, T25H, T27H, T30H, T40H, T45H, T50H, T55H, T60H
	8279008...50	10 Bit socket TX tamperproof 3/8", 90mm T8H, T10H, T15H, T20H, T25H, T27H, T30H, T40H, T45H, T50H
	8284804...12	7 Bit socket spline 3/8", M4, M5, M6, M8, M9, M10, M12
	8289005...12	6 Bit socket spline 3/8", 90mm M5, M6, M8, M9, M10, M12
	8294804...12	8 Bit socket ribe 3/8", M4, M5, M6, M7, M8, M9, M10, M12
	8299005...12	7 Bit socket ribe 3/8", 90mm M5, M6, M7, M8, M9, M10, M12
	- 41202	1 Hinged driver 1/4"-3/8"
	- 100301-2	1 Drill adaptor 3/8"

FOR A COMPLETE INVENTORY ORDER LIST SEE OUR WEBSITE

221803 - COMBINATINATION SET 3/8", SFS, 218-PCS (HEAVY DUTY)

XL

745 X 570MM

15560 GRAM

HEAVY DUTY



TOOLS	ART. NO.	CONTENTS
	22506...22	17 Flank socket 3/8", 6 pt. 6, 7, 8, 9, 10, 11, 12, 13, 14, 15, 16, 17, 18, 19, 20, 21, 22mm
	2256306...22	17 Flank deep socket 3/8", 6, 7, 8, 9, 10, 11, 12, 13, 14, 15, 16, 17, 18, 19, 20, 21, 22mm
	22806...22	17 Flank socket 3/8", 12 pt. 6, 7, 8, 9, 10, 11, 12, 13, 14, 15, 16, 17, 18, 19, 20, 21, 22mm
	2286306...22	17 Flank deep socket 3/8", 12 pt. 6, 7, 8, 9, 10, 11, 12, 13, 14, 15, 16, 17, 18, 19, 20, 21, 22mm
	22606...20	10 Socket TX 3/8", E6, E7, E8, E10, E11, E12, E14, E16, E18, E20
	2266306...20	10 Deep socket TX 3/8", E6, E7, E8, E10, E11, E12, E14, E16, E18, E20
	8214801...3	3 Bit socket PH 3/8", PH.1, PH.2, PH.3
	8224801...3	3 Bit socket PZ 3/8", PZ.1, PZ.2, PZ.3
	8244803...12	11 Bit socket hex 3/8", 3, 4, 5, 5.5, 6, 7, 8, 9, 10, 11, 12mm
	8249003...11	9 Bit socket hex 3/8", 90mmml 3, 4, 5, 6, 7, 8, 9, 10, 11mm
	8209003...11	9 Bit socket ball hex 3/8", 90mmml 3, 4, 5, 6, 7, 8, 9, 10, 11mm
	8264808...60	12 Bit socket TX 3/8", T8, T10, T15, T20, T25, T27, T30, T40, T45, T50, T55, T60
	8269008...50	10 Bit socket TX 3/8", 90mmml T8, T10, T15, T20, T25, T27, T30, T40, T45, T50
	8274808...60	12 Bit socket TX tamperproof 3/8", T8H, T10H, T15H, T20H, T25H, T27H, T30H, T40H, T45H, T50H, T55H, T60H
	8279008...50	10 Bit socket TX tamperproof 3/8", 90mmml T8H, T10H, T15H, T20H, T25H, T27H, T30H, T40H, T45H, T50H
	8284804...12	7 Bit socket spline 3/8", M4, M5, M6, M8, M9, M10, M12
	8289005...12	6 Bit socket spline 3/8", 90mmml M5, M6, M8, M9, M10, M12
	8294804...12	8 Bit socket ribe 3/8", M4, M5, M6, M7, M8, M9, M10, M12
	8299005...12	7 Bit socket ribe 3/8", 90mmml M5, M6, M7, M8, M9, M10, M12
	7142044...600	6 Extension 3/8" 44, 75, 150, 200, 450, 600mmml
	71923	1 Adaptor 3/8"(F) x 1/2"(M)
	71932	1 Adaptor 1/2"(F) x 3/8"(M)
	41202	1 Hinged driver 1/4"-3/8"
	7176208...14	4 Glow plug socket 3/8", 72I 8, 10, 12, 14mm
	71521	1 Universal joint 3/8"
	7110302	1 Disc ratchet 3/8" 72 teeth
	7152450	1 T-wrench universal joint 3/8" 450mmml
	7120102	1 Stubby ratchet 3/8" 45 teeth
	7121502	1 Ratchet 3/8" 60 teeth
	7121102	1 Twister ratchet 3/8"
	72602	1 Speedy T-grip 3/8"
	732210100	1 Torques wrench 3/8", 10-100NM
	7272250	1 Swivel grip handle 3/8" 250mmml
	100301-2	1 Drill adaptor 3/8"

FOR A COMPLETE INVENTORY ORDER LIST SEE OUR WEBSITE

314901 - COMBINATION SET 1/2", SFS, 149-PCS

XL

745 X 570MM

20200 GRAM



TOOLS	ART. NO.	CONTENTS
	23510...32	20 Flank socket 1/2", 6 pt. 10, 11, 12, 13, 14, 15, 16, 17, 18, 19, 20, 21, 22, 23, 24, 26, 27, 28, 30, 32mm
	23810...32	20 Flank socket 1/2", 12 pt. 10, 11, 12, 13, 14, 15, 16, 17, 18, 19, 20, 21, 22, 23, 24, 26, 27, 28, 30, 32mm
	23910...32	15 Flank socket 1/2", 12 pt. 3/8", 7/16", 1/2", 9/16", 5/8", 11/16", 3/4", 13/16", 7/8", 15/16", 1", 1.1/16", 1.1/8", 1.3/16", 1.1/4"
	23610...24	9 Socket TX 1/2", E10, E11, E12, E14, E16, E18, E20, E22, E24
	3310717...21	3 Wheel socket 1/2", 6 pt. 17, 19, 21mm
	3310617	1 Impact socket 1/2", 17mm for Mercedes-Benz 88mmml
	7110403	1 Swivel stubby ratchet 1/2" 72 teeth
	7121503	1 Ratchet 1/2" 60 teeth
	7110203	1 Swivel ratchet 1/2" 72 teeth
	71531	1 Universal joint 1/2"
	7273380	1 Swivel grip handle 1/2" 380mmml
	7233600	1 Swivel handle 1/2" 600mmml
	7143125...250	2 Extension 1/2" 125, 250mmml
	7263050...500	4 Wobble extension 1/2" 50, 125, 250, 500mmml
	71923	1 Adaptor 3/8"(F) x 1/2"(M)
	71932	1 Adaptor 1/2"(F) x 3/8"(M)
	71623	1 Adaptor for extension 3/8"(F) x 1/2"(M)
	71943	1 Adaptor 3/4"(F) x 1/2"(M)
	71934	1 Adaptor 1/2"(F) x 3/4"(M)
	732380400	1 1/2" torques wrench 80-400NM
	83406204...19	12 Bit socket hex 1/2", 4, 5, 5.5, 6, 7, 8, 9, 10, 12, 14, 17, 19mm
	834106205...17	10 Bit socket hex 1/2", 3/16", 1/4", 9/32", 5/16", 11/32", 3/8", 7/16", 1/2", 9/16", 5/8"
	83606220...70	10 Bit socket TX 1/2", T20, T25, T27, T30, T40, T45, T50, T55, T60, T70
	83706220...70	10 Bit socket TX tamperproof 1/2", T20H, T25H, T27H, T30H, T40H, T45H, T50H, T55H, T60H, T70H
	83806205...16	8 Bit socket spline 1/2", M5, M6, M7, M8, M9, M10, M12, M14, M16, M16T
	83806216T	1 Bit socket spline 1/2", M16T
	83805517	1 Bit socket spline 1/2", M17
	83906205...16	11 Bit socket ribe 1/2", M5, M6, M7, M8, M9, M10, M10-1, M12, M13, M14, M16

FOR A COMPLETE INVENTORY ORDER LIST SEE OUR WEBSITE

Sonic Foam System (SFS)

311501 - COMBINATINATION SET 1/2", SFS, 115-PCS (HEAVY DUTY)

XL

745 X 570MM

20200
GRAM

**HEAVY
DUTY**



TOOLS	ART. NO.	CONTENTS
	23508...32	22 Flank socket 1/2", 6 pt. 8, 9, 10, 11, 12, 13, 14, 15, 16, 17, 18, 19, 20, 21, 22, 23, 24, 26, 27, 28, 30, 32mm
	2357721...32	9 Flank deep socket 1/2", 6 pt. 21, 22, 23, 24, 26, 27, 28, 30, 32mm
	23610...22	9 Socket TX 1/2", E10, E11, E12, E14, E16, E18, E20, E22
	7121103	1 Twister ratchet 1/2"
	7121503	1 Ratchet 1/2" 60 teeth
	7110303	1 Disc ratchet 1/2", 72 teeth
	71531	1 Universal joint 1/2"
	7273380	1 Swivel grip handle 1/2" 380mm
	7233600	1 Swivel handle 1/2" 600mm
	7143125...250	2 Extension 1/2" 125, 250mm
	7263050...500	4 Wobble extension 1/2" 50, 125, 250, 500mm
	71923	1 Adaptor 3/8"(F) x 1/2"(M)
	71932	1 Adaptor 1/2"(F) x 3/8"(M)
	71623	1 Adaptor for extension 3/8"(F) x 1/2"(M)
	71943	1 Adaptor 3/4"(F) x 1/2"(M)
	71934	1 Adaptor 1/2"(F) x 3/4"(M)
	732380400	1 1/2" torques wrench 80-400NM
	83406205...14	8 Bit socket hex 1/2", 5, 6, 7, 8, 9, 10, 12, 14mm
	83606227...70	8 Bit socket TX 1/2", T27, T30, T40, T45, T50, T55, T60, T70
	83706227...70	8 Bit socket TX tamperproof 1/2", T27H, T30H, T40H, T45H, T50H, T55H, T60H, T70H
	83806205...14	7 Bit socket spline 1/2", M5, M6, M8, M9, M10, M12, M14
	83806216T	1 Bit socket spline 1/2", M16T
	83906207...16	8 Bit socket ribe 1/2", M7, M8, M9, M10, M12, M13, M14, M16

FOR A COMPLETE INVENTORY ORDER LIST SEE OUR WEBSITE

603402 - PLIERS & CUTTING SET, SFS, 34-PCS

XL

745 X 570MM

6948
GRAM



TOOLS	ART. NO.	CONTENTS
	4311175	1 Combination pliers 7"
	4321160	1 Long nose pliers
	4321200	1 Long nose pliers 8"
	4331200	1 Bent long nose pliers 8"
	4341175	1 Diagonal pliers 7"
	4341190	1 Universal diagonal pliers
	4351180	1 Waterpump pliers 7"
	4351250	1 Waterpump pliers 10"
	43611	1 Snap ring pliers (straight-open)
	43612	1 Snap ring pliers (straight-close)
	43613	1 Snap ring pliers (bent-open)
	43614	1 Snap ring pliers (bent-close)
	4380250	1 Locking pliers 10"
	4381150	1 Long nose locking pliers 150mm
	4382125	1 Curved jaw locking pliers 125mm
	4391175	1 Locking pliers for brake and air plug
	4333270	1 Long nose pliers 11" 90 degree bent
	4393003	1 Circle nose pliers 11"-1"
	4471180	1 Wire stripper 7"
	44005	1 Multi-grip pliers straight jaw
	46702	1 Shears left 7"
	46703	1 Shears right 7"
	47023	1 Brake fluid tester
	4820207	1 Flexible magnet pickup 500g
	81301	1 Crimping pliers
	81302	1 Jaw for crimping insulated terminals A
	81303	1 Jaw for crimping non-insulated terminals B
	81304	1 Jaw for crimping open barrel terminals C
	81305	1 Jaw for cord-end terminal D (small sizes)
	81306	1 Jaw for cord-end terminal F (big sizes)
	81307	1 Jaw for crimping open barrel Terminals H (small sizes)
	600308	3 Hose line clamp set 3-pcs

FOR A COMPLETE INVENTORY ORDER LIST SEE OUR WEBSITE

603209 - PLIERS SET, SFS, 32-PCS (HEAVY DUTY)

XL

745 X 570MM

7790 GRAM

HEAVY DUTY



TOOLS	ART. NO.	CONTENTS
	- 4311175	1 Combination pliers 7"
	- 4322160	1 Long nose pliers 6"
	- 4321200	1 Long nose pliers 8"
	- 4331200	1 Bent long nose pliers 8"
	- 4341180	1 Diagonal side cutting pliers 7"
	- 4351180...400	3 Waterpump pliers 7", 10", 16"
	4820516	1 Pocket-sized, ultra-slim work light
	- 4393004	1 Snap ring pliers (straight close) ø 40-100mm
	- 4393005	1 Snap ring pliers (straight open) ø 40-100mm
	- 4393006	1 Snap ring pliers (bent close) ø 40-100mm
	- 4393007	1 Snap ring pliers (bent open) ø 40-100mm
	- 4380250	1 Locking pliers 10"
	- 4382125	1 Curved jaw locking pliers 125mm
	- 4391175	1 Locking pliers for brake and air plug
	- 4720107	1 Empty tray (54x110x45mm)
	- 4471180	1 Wire stripper 7"
	- 46702	1 Shears left 7"
	- 46703	1 Shears right 7"
	- 46704	1 Combi scissors
	- 4820207	1 Flexible magnet pickup 500g
	- 81301	1 Crimping pliers
	- 81302	1 Jaw for crimping insulated terminals A
	- 81303	1 Jaw for crimping non-insulated terminals B
	- 81304	1 Jaw for crimping open barrel terminals C
	- 81305	1 Jaw for cord-end terminal D (small sizes)
	- 81306	1 Jaw for cord-end terminal F (big sizes)
	- 81307	1 Jaw for crimping open barrel Terminals H (small sizes)
	- 600308	3 Hose line clamp set 3-pcs

FOR A COMPLETE INVENTORY ORDER LIST SEE OUR WEBSITE

607201 - WRENCH SET, SFS, 72-PCS

XL

745 X 570MM

11900 GRAM



TOOLS	ART. NO.	CONTENTS
	- 4081011	1 Flexible flare nut wrench 10x11mm
	- 4110810...1719	5 Flare nut wrench 8x10, 11x13, 12x14, 16x18, 17x19mm
	- 41506...36	28 Combination wrench 6, 7, 8, 9, 10, 11, 12, 13, 14, 15, 16, 17, 18, 19, 20, 21, 22, 23, 24, 25, 26, 27, 28, 29, 30, 32, 34, 36mm
	- 42608...17	10 Stubby combination wrench 8, 9, 10, 11, 12, 13, 14, 15, 16, 17mm
	- 4190607...2122	8 75 offset ring wrench 6x7, 8x9, 10x11, 12x13, 14x15, 16x17, 18x19, 21x22mm
	- 4170208...19	12 Reversible ratcheting wrench 12 pt. 8, 9, 10, 11, 12, 13, 14, 15, 16, 17, 18, 19mm
	4160608...2024	4 TX wrench E6xE8, E10xE12, E14xE18, E20xE24
	41760608...2024	4 TX wrench E6xE8, E10xE12, E14xE18, E20xE24

FOR A COMPLETE INVENTORY ORDER LIST SEE OUR WEBSITE

604501 - SCREWDRIVER SET, SFS, 45-PCS

XL

745 X 570MM

4240 GRAM



TOOLS	ART. NO.	CONTENTS
	1310...3	4 Screwdriver PH, PH.0, PH.1, PH.2, PH.3
	1311S...2S	2 Screwdriver stubby PH, PH.1, PH.2
	13303...10	7 Screwdriver slotted, 3.0, 3.5, 4, 5.5, 6.5, 8, 10
	133055S...65S	2 Screwdriver stubby slotted, 5.5, 6.5mm
	13605...40	12 Screwdriver TX, T5, T6, T7, T8, T9, T10, T15, T20, T25, T27, T30, T40
	13625015...45	7 Screwdriver TX, 250mm T15, T20, T25, T27, T30, T40, T45
	- 47902	1 Door upholstery panel remover 110mm
	- 47903	1 Scraper
	- 47904	1 Cotter pin puller
	- 47905	1 Radiator hose remover
	- 47906	1 Trim pad tool 1/4"x115mm
	- 47907	1 Trim pad tool 5/16"x115mm
	- 47908	1 Door upholstery panel remover 132mm
	- 47833...34	2 Straight removal tool 3x63, 3x133mm
	- 47835...36	2 Angle removal tool 3x63, 3x133mm

FOR A COMPLETE INVENTORY ORDER LIST SEE OUR WEBSITE

Sonic Foam System (SFS)

606302 - CHISEL AND UTILITY TOOLS SET, SFS, 63-PCS, (HEAVY DUTY)

XL

745 X 570MM

7110 GRAM

HEAVY DUTY



TOOLS	ART. NO.	CONTENTS
	- 4811254	1 Steel wire brush
	- 46806-1	1 10-pcs spare blades dispenser (46806)
	- 47006	1 Feeler gauge 20-pcs, 0.05-1.00mm
	- 46806	1 Utility knife (incl. 10 blades)
	600902	9 TX key set extra long, 9-pcs
	601008	10 Hex ball key set extra long 10-pcs, 1.27, 1.5, 2, 2.5, 3, 4, 5, 6, 8, 10mm
	- 47003	1 Stainless steel vernier caliper
	- 47032	1 Stainless square ruler 200x125mm
	- 47005	1 Stainless steel protractor
	- 47013	1 Measuring tape 5 meter
	- 47028	1 Tire profile gauge 50mm
	- 812008	1 Hinged chain wrench for oil filters
	- 46911	1 Flat file 8"
	- 46912	1 Half round file 8"
	- 46913	1 Round file 8"
	- 46914	1 Triangular file 8"
	- 47004	1 Stainless steel straight ruler 30cm
	- 46905	1 Triangular file for brakes 8"
	- 45310230	1 Grip Pin punch 230mmL 10"
	- 45312250	1 Grip Pin punch 250mmL 12"
	- 45314290	1 Grip Pin punch 290mmL 14"
	- 45316310	1 Grip Pin punch 310mmL 16"
	- 45602	1 Auto center punch
	- 4820110	1 Telescopic magnet
	- 47817	1 Plastic scraper
	- 4820111	1 Telescopic mirror 31-61cm
	- 4821301	1 Wedge (190x30mm) universal
	- 46601	1 Super heavy duty hacksaw

FOR A COMPLETE INVENTORY ORDER LIST SEE OUR WEBSITE

606601 - WRENCH SET, SFS, 66-PCS (HEAVY DUTY)

XL

745 X 570MM

7110 GRAM

HEAVY DUTY

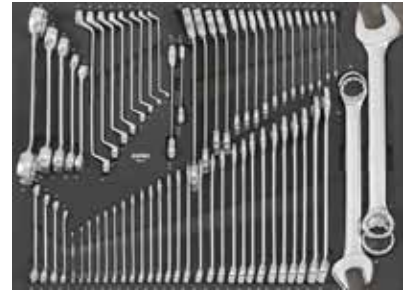

TOOLS	ART. NO.	CONTENTS
	- 4110810...3641	5 Flare nut wrench 8x10, 11x13, 12x14, 16x18, 17x19, 19x22, 24x27, 30x32, 36x41mm
	- 4190607...2022	8 75° offset ring wrench 6x7, 8x9, 10x11, 12x13, 14x15, 16x17, 18x19, 20x22mm
	- 4170401...02	2 4-in-1 ring ratcheting wrench 8-10, 12-13; 16-17, 18-19mm
	- 4170208...22	14 Reversible ratcheting wrench 12 pt. 8-10, 12-13; 16-17, 18-19mm
	- 41506...46	31 Combination wrench 6, 7, 8, 9, 10, 11, 12, 13, 14, 15, 16, 17, 18, 19, 20, 21, 22, 23, 24, 25, 26, 27, 28, 29, 30, 32, 34, 36, 38, 41, 46mm

FOR A COMPLETE INVENTORY ORDER LIST SEE OUR WEBSITE



**WORK
EFFICIENT
WORK
WITH SONIC**





**WORK
EFFICIENT
WORK
WITH SONIC**



SONIC
BMCS

Taking organization & efficiency
to the next level.

04 > Blow Mould Case Storage (BMCS)



> BMCS 1/4"
PAGE 165, 171



> BMCS SAE
PAGE 173



> BMCS 3/8"
PAGE 166, 172



> BMCS empty
PAGE 174



> BMCS 1/2"
PAGE 168

101105 - TPMS SET 11-PCS BMCS

1600 GRAM



TOOLS	ART. NO.	CONTENTS
	- 73310002	1 1/4" Torques driver 0.4-2Nm 3-15 inch-pounds
	- 73310109	1 1/4" Torques driver 1-9Nm 10-80 inch-pounds
	- 47825	1 Trim removal
	- 47826	1 Tyre valve driver 0.25Nm
	- 47827	1 Tyre valve driver 0.45Nm
	● 2155011...12	2 Flank deep socket 1/4", 6 pt. 11, 12mm
	- 7131115	1 Sliding T-handle 1/4"
	- 7191125	1 Adaptor bit 1/4" hex-1/4" square 25mm
	⊛ 8163710...20	2 Bit socket TX 1/4", T10, T20

104001 - COMBINATION SET 1/4", 40-PCS BMCS

1360 GRAM



TOOLS	ART. NO.	CONTENTS
	- 7121501	1 Ratchet 1/4" 60 teeth
	● 21503...14	14 Flank socket 1/4", 6 pt. 3, 4, 4.5, 5, 5.5, 6, 7, 8, 9, 10, 11, 12, 13, 14mm
	○ 8143703...08	5 Bit socket hex 1/4", 3, 4, 5, 6, 8mm
	⊛ 8163710...40	6 Bit socket TX 1/4", T10, T15, T20, T25, T30, T40
	◐ 8133704...65	3 Bit socket slotted 1/4", 4, 5, 5.5, 6.5mm
	⊕ 8113701...03	3 Bit socket PH 1/4", PH.1, PH.2, PH.3
	⊕ 8123701...03	3 Bit socket PZ 1/4", PZ.1, PZ.2, PZ.3
	- 7131115	1 Sliding T-handle 1/4"
	- 7141050...100	2 Extension 1/4" 50, 100mm
	- 71511	1 Universal joint 1/4"
	- 72401	1 Spinner 1/4" 150mm

103502 - SOCKET & BIT SET 1/4", 35-PCS BMCS

1220 GRAM



TOOLS	ART. NO.	CONTENTS
	- 7121501	1 Ratchet 1/4" 60 teeth
	● 21504...13	12 Flank socket 1/4", 6 pt. 4, 4.5, 5, 5.5, 6, 7, 8, 9, 10, 11, 12, 13mm
	- 7141050	1 Extension 1/4" 50mm
	- 71511	1 Universal joint 1/4"
	- 7131115	1 Sliding T-handle 1/4"
	- 72401	1 Spinner 1/4" 150mm
	⊕ 8113700...03	4 Bit socket PH 1/4", PH.0, PH.1, PH.2, PH.3
	◐ 8133704...65	3 Bit socket slotted 1/4", 4, 5.5, 6.5mm
	○ 8143703...06	4 Bit socket hex 1/4", 3, 4, 5, 6mm
	⊛ 8163710...40	7 Bit socket TX 1/4", T10, T15, T20, T25, T27, T30, T40

104602 - COMBINATION SET 1/4", 46-PCS BMCS

1660 GRAM



TOOLS	ART. NO.	CONTENTS
	- 7121501	1 Ratchet 1/4" 60 teeth
	- 184-3	3 Hex key wrench 1.5, 2, 2.5mm
	- 7191125	1 Adaptor bit 1/4" hex-1/4" square 25mm
	● 21504...14	13 Flank socket 1/4", 6 pt. 4, 4.5, 5, 5.5, 6, 7, 8, 9, 10, 11, 12, 13, 14mm
	- 7131115	1 Sliding T-handle 1/4"
	- 7141050...100	2 Extension 1/4" 50, 100mm
	- 71511	1 Universal joint 1/4"
	- 7211	1 Flexible extension 1/4"
	- 72401	1 Spinner 1/4" 150mm
	⊕ 8113701...03	3 Bit socket PH 1/4", PH.1, PH.2, PH.3
	⊕ 8123701...03	3 Bit socket PZ 1/4", PZ.1, PZ.2, PZ.3
	◐ 8133704...65	3 Bit socket slotted 1/4", 4, 5.5, 6.5mm
	○ 8143703...08	6 Bit socket hex 1/4", 3, 4, 5, 6, 7, 8mm
	⊛ 8163710...40	6 Bit socket TX 1/4", T10, T15, T20, T25, T30, T40

107403 - COMBINATION SET 1/4", 74-PCS BMCS

2680 GRAM



TOOLS	ART. NO.	CONTENTS
	21504...13	12 Flank socket 1/4", 6 pt. 4, 4.5, 5, 5.5, 6, 7, 8, 9, 10, 11, 12, 13mm
	2155004...13	12 Flank deep socket 1/4", 6 pt. 4, 4.5, 5, 5.5, 6, 7, 8, 9, 10, 11, 12, 13mm
	21604...10	6 Socket TX 1/4", E4, E5, E6, E7 E8, E10
	2165004...10	6 Deep TX socket 1/4", E4, E5, E6, E7 E8, E10
	- 7131115	1 Sliding T-handle 1/4"
	- 7141050...100	2 Extension 1/4" 50, 100mm
	- 71511	1 Universal joint 1/4"
	- 72225	1 Magnet socket pick-up 1/4"
	- 72401	1 Spinner 1/4" 150mm
	8113701...03	3 Bit socket PH 1/4", PH.1, PH.2, PH.3
	8123701...03	3 Bit socket PZ 1/4", PZ.1, PZ.2, PZ.3
	8133704...65	3 Bit socket slotted 1/4", 4, 5.5, 6.5mm
	8143703...08	6 Bit socket hex 1/4", 3, 4, 5, 6, 7, 8mm
	8163708...40	8 Bit socket TX 1/4", T8, T10, T15, T20, T25, T27, T30, T40
	8173708...40	8 Bit socket TX tamperproof 1/4", T8H, T10H, T15H, T20H, T25H, T27H, T30H, T40H
	- 7121501	1 Ratchet 1/4" 60 teeth

200804 - SAMPLE SET SONIC, 8-PCS BMCS

1700 GRAM



TOOLS	ART. NO.	CONTENTS
	- 7121502	1 Ratchet 3/8" 60 teeth
	1312	1 Screwdriver, PH.2
	22517	1 Flank socket 3/8", 6 pt. 17mm
	2256317	1 Flank deep socket 3/8", 6 pt. 17mm
	- 41517	1 Combination wrench 17mm
	- 4311175	1 Combination pliers 7"
	- 7110302	1 Disc ratchet 3/8", 72 teeth
	8264840	1 Bit socket TX 3/8", T40

202803 - SOCKET SET 3/8", 28-PCS BMCS

3320 GRAM



TOOLS	ART. NO.	CONTENTS
	22506...22	17 Flank socket 3/8", 6 pt. 6, 7, 8, 9, 10, 11, 12, 13, 14, 15, 16, 17, 18, 19, 20, 21, 22mm
	- 7142044...250	4 Extension 3/8" 44, 75, 150, 250mm
	- 7121502	1 Ratchet 3/8" 60 teeth
	- 71521	1 Universal joint 3/8"
	- 71632	1 Adaptor for extension 1/2"(F) x 3/8"(M)
	7171216...21	3 Spark plug socket 3/8" 16, 18, 21mm
	- 7272250	1 Swivel handle 3/8" 250mm



203703 - SOCKET AND WRENCH SET 3/8", 37-PCS BMCS

3540 GRAM



TOOLS	ART. NO.	CONTENTS
	- 7121502	1 Ratchet 3/8" 60 teeth
	22506...22	17 Flank socket 3/8", 6 pt. 6, 7, 8, 9, 10, 11, 12, 13, 14, 15, 16, 17, 18, 19, 20, 21, 22mm
	- 41506...19	14 Combination wrench 6, 7, 8, 9, 10, 11, 12, 13, 14, 15, 16, 17, 18, 19mm
	- 7142044...150	3 Extension 3/8" 44, 75, 150mm
	- 71521	1 Universal joint 3/8"
	- 71632	1 Adaptor for extension 1/2"(F) x 3/8"(M)

204003 - COMBINATION SET 3/8", 40-PCS BMCS

3080 GRAM



TOOLS	ART. NO.	CONTENTS
	- 7121502	1 Ratchet 3/8" 60 teeth
	22506...22	17 Flank socket 3/8", 6 pt. 6, 7, 8, 9, 10, 11, 12, 13, 14, 15, 16, 17, 18, 19, 20, 21, 22mm
	- 7142044...150	3 Extension 3/8" 44, 75, 150mm
	- 71521	1 Universal joint 3/8"
	- 71632	1 Adaptor for extension 1/2"(F) x 3/8"(M)
	8244804...08	5 Bit socket hex 3/8", 4, 5, 6, 7, 8mm
	8264820...50	7 Bit socket TX 3/8", T20, T25, T27, T30, T40, T45, T50
	8284805...12	5 Bit socket spline 3/8", M5, M6, M8, M10, M12

206102 - SOCKET & BIT SOCKET SET 3/8", 61-PCS BMCS

4380 GRAM



TOOLS	ART. NO.	CONTENTS
	- 7121502	1 Ratchet 3/8" 60 teeth
	22506...24	18 Flank socket 3/8", 6 pt. 6, 7, 8, 9, 10, 11, 12, 13, 14, 15, 16, 17, 18, 19, 20, 21, 22, 24mm
	2256308...19	10 Flank deep socket 3/8", 6 pt. 8, 9, 10, 11, 12, 13, 14, 15, 17, 19mm
	- 7142075...250	2 Extension 3/8" 75, 250mm
	- 71521	1 Universal joint 3/8"
	- 71632	1 Adaptor for extension 1/2"(F) x 3/8"(M)
	7171216...21	2 Spark plug socket 3/8" 16, 21mm
	8214801...03	3 Bit socket PH 3/8", PH.1, PH.2, PH.3
	8224801...03	3 Bit socket PZ 3/8", PZ.1, PZ.2, PZ.3
	82348055...08	3 Bit socket slotted 3/8", 5.5, 7, 8mm
	8244803...10	7 Bit socket hex 3/8", 3, 4, 5, 6, 7, 8, 10mm
	8264810...55	10 Bit socket TX 3/8", T10, T15, T20, T25, T27, T30, T40, T45, T50, T55

207601 - SOCKET & BIT SOCKET SET 1/2", 76-PCS BMCS

1140 GRAM



TOOLS	ART. NO.	CONTENTS
	- 7121502	1 Ratchet 3/8" 60 teeth
	22506...24	18 Flank socket 3/8", 6 pt. 6, 7, 8, 9, 10, 11, 12, 13, 14, 15, 16, 17, 18, 19, 20, 21, 22, 24mm
	2256308...22	13 Flank deep socket 3/8", 6 pt. 8, 9, 10, 11, 12, 13, 14, 15, 16, 17, 18, 19, 22mm
	8244803...10	7 Bit socket hex 3/8", 3, 4, 5, 6, 7, 8, 10mm
	8214801...03	3 Bit socket PH 3/8", PH.1, PH.2, PH.3
	8224801...03	3 Bit socket PZ 3/8", PZ.1, PZ.2, PZ.3
	82348055...08	4 Bit socket slotted 3/8", 5.5, 6, 7, 8mm
	8264808...55	11 Bit socket TX 3/8", T8, T10, T15, T20, T25, T27, T30, T40, T45, T50, T55
	8274810...55	10 Bit socket TX tamperproof 3/8", T10H, T15H, T20H, T25H, T27H, T30H, T40H, T45H, T50H, T55H
	- 7142075...250	2 Extension 3/8" 75, 250mm
	- 71521	1 Universal joint 3/8"
	7171216...21	2 Spark plug socket 3/8" 16, 21mm
	- 71632	1 Adaptor for extension 1/2"(F) x 3/8"(M)

300817 - BIT SOCKET TX SET 1/2", 8-PCS BMCS

1400 GRAM



TOOLS	ART. NO.	CONTENTS
	83606227...70	8 Bit socket TX 1/2", T27, T30, T40, T45, T50, T55, T60, T70

300818 - TX BIT SOCKET SET 1/2", 8-PCS BMCS

1390 GRAM



TOOLS	ART. NO.	CONTENTS
	83610027...70	8 Bit socket TX 1/2", 100mm T27, T30, T40, T45, T50, T55, T60, T70

300816 - BIT SOCKET HEX SET 1/2", 8-PCS BMCS

1480 GRAM



TOOLS	ART. NO.	CONTENTS
	83410006...17	8 Bit socket hex 1/2", 100mm 6, 7, 8, 9, 10, 12, 14, 17mm

300819 - BIT SOCKET SPLINE SET 1/2", 8-PCS BMCS

1220 GRAM



TOOLS	ART. NO.	CONTENTS
	83806205...16	8 Bit socket spline 1/2", M5, M6, M8, M9, M10, M12, M14, M16

300820 - BIT SOCKET SPLINE SET 1/2", 8-PCS BMCS

1480 GRAM



TOOLS	ART. NO.	CONTENTS
	83810005...16	8 Bit socket spline 1/2", 100mm M5, M6, M8, M9, M10, M12, M14, M16

300823 - BIT SOCKET HEX SET 1/2", 8-PCS BMCS

1280 GRAM



TOOLS	ART. NO.	CONTENTS
	83406206...17	8 Bit socket hex 1/2", 6, 7, 8, 9, 10, 12, 14, 17mm

04

300821 - BIT SOCKET RIBE SET 1/2" 8-PCS BMCS

1220 GRAM



TOOLS	ART. NO.	CONTENTS
	83906206...14	8 Bit socket ribe 1/2", M6, M7, M8, M9, M10, M12, M13, M14

301702 - BIT SOCKET TX 1/2", 17-PCS BMCS

1280 GRAM



TOOLS	ART. NO.	CONTENTS
	23610...24	9 Socket TX 1/2", E10, E11, E12, E14, E16, E18, E20, E22, E24
	83606225...60	8 Bit socket TX 1/2", T25, T27, T30, T40, T45, T50, T55, T60

300822 - BIT SOCKET RIBE SET 1/2", 8-PCS BMCS

1440 GRAM



TOOLS	ART. NO.	CONTENTS
	83910006...14	8 Bit socket ribe 1/2", 100mm M6, M7, M8, M9, M10, M12, M13, M14

301904 - SOCKET SET 1/2", 19-PCS BMCS

3800 GRAM



TOOLS	ART. NO.	CONTENTS
	7121503	1 Ratchet 1/2" 60 teeth
	23510...24	14 Flank socket 1/2", 6 pt. 10, 11, 12, 13, 14, 15, 16, 17, 18, 19, 21, 22, 23, 24mm
	7133250	1 Sliding T-handle 1/2"
	7143125...250	2 Extension 1/2" 125, 250mm
	71531	1 Universal joint 1/2"

304501 - SOCKET AND WRENCH SET 1/2", 45-PCS BMCS

6660 GRAM



306701 - TX SET, 67-PCS BMCS

4880 GRAM



04

TOOLS	ART. NO.	CONTENTS
	- 7121503	1 Ratchet 1/2" 60 teeth
	23508...32	23 Flank socket 1/2", 6 pt. 8, 9, 10, 11, 12, 13, 14, 15, 16, 17, 18, 19, 20, 21, 22, 23, 24, 25, 26, 27, 28, 30, 32mm
	- 7143125...250	2 Extension 1/2" 125, 250mm
	- 71531	1 Universal joint 1/2"
	7171316...21	2 Spark plug socket 1/2" 16, 21mm
	- 71623	1 Adaptor for extension 3/8"(F) x 1/2"(M)
	- 41506...22	15 Combination wrench 6, 7, 8, 9, 10, 11, 12, 13, 14, 15, 16, 17, 18, 19, 22mm

TOOLS	ART. NO.	CONTENTS
	13606...40	9 Screwdriver TX, T6, T8, T10, T15, T20, T25, T27, T30, T40
	1860108...70	14 Key wrench TX, extra long T8, T9, T10, T15, T20, T25, T27, T30, T40, T45, T50, T55, T60, T70
	21604...10	6 Socket TX 1/4", E4, E5, E6, E7, E8, E10
	23611...24	8 Socket TX 1/2", E11, E12, E14, E16, E18, E20, E22, E24
	4160608...2024	4 TX wrench E6xE8, E10xE12, E14xE18, E20xE24
	8163708...40	9 Bit socket TX 1/4", T8, T9, T10, T15, T20, T25, T27, T30, T40
	83706250...60	3 Bit socket TX tamperproof 1/2", TX T50H, T55H, T60H
	9367520...55	7 Bit TX 10mm, 75mm T20, T25, T30, T40, T45, T50, T55
	9373015...45	6 Bit TX 10mm tamperproof, 30mm T15H, T20H, T25H, T30H, T40H, T45H
	- 72033	1 Bit holder, 1/2"(F)x10mm(F)

302404 - SOCKET SET 1/2", 24-PCS BMCS

5040 GRAM



TOOLS	ART. NO.	CONTENTS
	- 7121503	1 Ratchet 1/2" 60 teeth
	23510...32	18 Flank socket 1/2", 6 pt. 10, 11, 12, 13, 14, 15, 16, 17, 18, 19, 20, 21, 22, 23, 24, 27, 30, 32mm
	- 7143125...250	2 Extension 1/2" 125, 250mm
	- 71531	1 Universal joint 1/2"
	- 71623	1 Adaptor for extension 3/8"(F) x 1/2"(M)
	- 7273380	1 Swivel handle 1/2" 380mm

B M C S
BLOW MOULD CASE STORAGE



307603 - SOCKET SET 1/4" & 1/2", 76-PCS BMCS

5740 GRAM



309101 - SOCKET SET 1/4" & 1/2", 91-PCS BMCS

8500 GRAM



04

TOOLS	ART. NO.	CONTENTS
	21504...13	12 Flank socket 1/4", 6 pt. 4, 4.5, 5, 5.5, 6, 7, 8, 9, 10, 11, 12, 13mm
	8113701...03	3 Bit socket PH 1/4", PH.1, PH.2, PH.3
	8123701...03	3 Bit socket PZ 1/4", PZ.1, PZ.2, PZ.3
	8133704...65	3 Bit socket slotted 1/4", 4, 5.5, 6.5mm
	8143703...10	7 Bit socket hex 1/4", 3, 4, 5, 6, 7, 8, 10mm
	8163708...40	8 Bit socket TX 1/4", T8, T10, T15, T20, T25, T27, T30, T40
	8173708...40	8 Bit socket TX tamperproof 1/4", T8H, T10H, T15H, T20H, T25H, T27H, T30H, T40H
	- 7121501	1 Ratchet 1/4" 60 teeth
	- 7131115	1 Sliding T-handle 1/4"
	- 7141050...150	3 Extension 1/4" 50mm, 100, 150mm
	- 71511	1 Universal joint 1/4"
	- 72401	1 Spinner 150mm 1/4"
	23508...32	20 Flank socket 1/2", 6 pt. 8, 9, 10, 11, 12, 13, 14, 15, 16, 17, 18, 19, 20, 21, 22, 23, 24, 27, 30, 32mm
	- 7121503	1 Ratchet 3/8" 60 teeth
	- 7143125...250	2 Extension 1/2" 125, 250mm
	- 71531	1 Universal joint 1/2"
	- 71623	1 Adaptor for extension 3/8"(F) x 1/2"(M)

TOOLS	ART. NO.	CONTENTS
	21503...14	14 Flank socket 1/4", 6 pt. 3, 4, 4.5, 5, 5.5, 6, 7, 8, 9, 10, 11, 12, 13, 14mm
	2155006...13	8 Flank deep socket 1/4", 6 pt. 6, 7, 8, 9, 10, 11, 12, 13mm
	8113701...03	3 Bit socket PH 1/4", PH.1, PH.2, PH.3
	8123701...03	3 Bit socket PZ 1/4", PZ.1, PZ.2, PZ.3
	8133704...065	3 Bit socket slotted 1/4" 4, 5.5, 6.5mm
	8143703...06	4 Bit socket hex 1/4" 3, 4, 5, 6mm
	8163708...40	8 Bit socket TX 1/4" T8, T10, T15, T20, T25, T27, T30, T40
	- 7121501	1 Ratchet 1/4" 60 teeth
	- 7131115	1 Sliding T-handle 1/4"
	- 7141050...100	2 Extension 1/4" 50, 100mm
	- 71511	1 Universal joint 1/4"
	- 72401	1 Spinner 1/4" 150mm
	23510...32	14 Flank socket 1/2", 6 pt. 10, 13, 15, 16, 17, 18, 19, 20, 21, 22, 24, 27, 30, 32mm
	2357714...19	4 Flank deep socket 1/2", 6 pt. 14, 15, 17, 19mm
	7171316...21	2 Spark plug socket 1/2", 16, 21mm
	83606250...60	3 Bit socket TX 1/2", T50, T55, T60
	- 7121503	1 Ratchet 1/2" 60 teeth
	- 7143125...250	2 Extension 1/2" 125, 250mm
	- 71531	1 Universal joint 1/2"
	- 71623	1 Adaptor for extension 3/8"(F) x 1/2"(M)
	- 72032	1 Bit holder 1/2"(F) x 5/16"(F)
	9213002...04	3 Bit PH 5/16" 30mm, PH.2, PH.3, PH.4
	9223002...04	3 Bit PZ 5/16" 30mm, PZ.2, PZ.3, PZ.4
	9233006...12	4 Bit slotted 5/16" 30mm, 6, 8, 10, 12mm
	9263030...45	3 Bit TX 5/16" 30mm, T30, T40, T45

309402 - SOCKET SET 1/4" & 1/2", 94-PCS BMCS

6460 GRAM



309901 - SOCKET SET 1/4", 3/8" & 1/2", 99-PCS BMCS

8500 GRAM



04

TOOLS	ART. NO.	CONTENTS
	- 184-3	3 Hex key wrench 1.5, 2, 2.5mm
	21504...14	13 Flank socket 1/4", 6 pt. 4, 4.5, 5, 5.5, 6, 7, 8, 9, 10, 11, 12, 13, 14mm
	2155006...13	8 Flank deep socket 1/4", 6 pt. 6, 7, 8, 9, 10, 11, 12, 13mm
	8113701...02	2 Bit socket PH 1/4", PH.1, PH.2
	8123701...02	2 Bit socket PZ 1/4", PZ.1, PZ.2
	8133704...65	3 Bit socket slotted 1/4", 4, 5.5, 6.5mm
	8143703...06	4 Bit socket hex 1/4", 3, 4, 5, 6mm
	8163708...30	7 Bit socket TX 1/4" T8, T10, T15, T20, T25, T27, T30
	- 7121501	1 Ratchet 1/4" 60 teeth
	- 7131115	1 Sliding T-handle 1/4"
	- 7141050...100	2 Extension 1/4" 50, 100mm
	- 71511	1 Universal joint 1/4"
	- 72401	1 Spinner 1/4" 150mm
	23510...32	17 Flank socket 1/2", 6 pt. 10, 11, 12, 13, 14, 15, 16, 17, 18, 19, 20, 21, 22, 24, 27, 30, 32mm
	2357713...22	5 Flank deep socket 1/2", 6 pt. 13, 15, 17, 19, 22mm
	7171316...21	2 Spark plug socket 1/2", 16, 21mm
	- 7121503	1 Ratchet 1/2", 60 teeth
	- 7143125...250	2 Extension 1/2", 125, 250mm
	- 71531	1 Universal joint 1/2"
	- 71623	1 Adaptor 3/8"(F) x 1/2"(M)
	- 72032	1 Bit holder 1/2"(F) x 5/16"(F)
	9213003...04	2 Bit PH 5/16", 30mm PH.3, PH.4
	9223003...04	2 Bit PZ 5/16", 30mm PZ.3, PZ.4
	9233008...12	3 Bit slotted 5/16", 30mm 8, 10, 12mm
	9243007...14	5 Bit hex 5/16", 30mm 7, 8, 10, 12, 14mm
	9263040...55	4 Bit TX 5/16", 30mm T40, T45, T50, T55

TOOLS	ART. NO.	CONTENTS
	21504...13	12 Flank socket 1/4", 6 pt. 4, 4.5, 5, 5.5, 6, 7, 8, 9, 10, 11, 12, 13mm
	22510...19	10 Flank socket 3/8", 6 pt. 10, 11, 12, 13, 14, 15, 16, 17, 18, 19mm
	23517...32	13 Flank deep socket 1/2", 6 pt. 17, 18, 19, 20, 21, 22, 23, 24, 26, 27, 28, 30, 32mm
	21604...10	6 Socket TX 1/4", E4, E5, E6, E7, E8, E10
	22611...20	6 Socket TX 3/8", E11, E12, E14, E16, E18, E20
	- 41506	16 Combination wrench 6, 7, 8, 9, 10, 11, 12, 13, 14, 15, 16, 17, 18, 19, 20, 22mm
	7171316...21	2 Spark plug socket 1/2", 16, 21mm
	8113701...02	2 Bit socket PH 1/4", PH.1, PH.2
	8123701...02	2 Bit socket PZ 1/4", PZ.1, PZ.2
	8133704...65	3 Bit socket slotted 1/4", 4, 5.5, 6.5mm
	8143703...06	4 Bit socket hex 1/4", 3, 4, 5, 6
	8163708...30	8 Bit socket TX 1/4", T8, T9, T10, T15, T20, T25, T27, T30
	- 7121501	1 Ratchet 1/4" 60 teeth
	- 7121502	1 Ratchet 3/8", 60 teeth
	- 7121503	1 Ratchet 1/2", 60 teeth
	- 7131115	1 Sliding T-handle 1/4"
	- 7141050...100	2 Extension 1/4", 50, 100mm
	- 7262075...150	2 Wobble extension 3/8", 75, 150mm
	- 7263125...250	2 Wobble extension 1/2", 125, 250mm
	- 71511	1 Universal joint 1/4"
	- 71521	1 Universal joint 3/8"
	- 71531	1 Universal joint 1/2"
	- 71921	1 Adaptor 3/8"(F) x 1/4"(M)
	- 71932	1 Adaptor 1/2"(F) x 3/8"(M)

103202 - COMBINATION SET 1/4", 32-PCS BMCS (SAE)



TOOLS	ART. NO.	CONTENTS
	21905...13	9 Flank socket 1/4", 12 pt. 3/16", 7/32", 1/4", 9/32", 5/16", 11/32", 3/8", 7/16", 1/2"
	8113700...03	4 Bit socket PH 1/4", bit PH.0, PH.1, PH.2, PH.3
	8133704...65	3 Bit socket slotted 1/4", 4, 5.5, 6.5
	81413703...06	4 Bit socket hex 1/4", 1/8", 5/32", 3/16", 7/32"
	8163710...40	7 Bit socket TX 1/4", T10, T15, T20, T25, T27, T30, T40
	- 7121501	1 Ratchet 1/4" 60 teeth
	- 7131115	1 Sliding T-handle 1/4"
	- 7141050	1 Extension 1/4", 50mmml
	- 71511	1 Universal joint 1/4"
	- 72401	1 Spinner 1/4", 150mmml

205301 - SOCKET & BITSOCKET SET 3/8" 53-PCS BMCS (SAE)



TOOLS	ART. NO.	CONTENTS
	22906...21	10 Flank socket 3/8", 12 pt. 1/4", 5/16", 3/8", 7/16", 1/2", 9/16", 5/8", 11/16", 3/4", 13/16"
	2296306...21	10 Flank deep socket 3/8", 12 pt. 1/4", 5/16", 3/8", 7/16", 1/2", 9/16", 5/8", 11/16", 3/4", 13/16"
	82414803...12	7 Bit socket hex 3/8" 1/8", 5/32", 3/16", 1/4", 5/16", 3/8", 7/16"
	8214801...03	3 Bit socket PH 3/8", PH.1, PH.2, PH.3
	8224801...03	3 Bit socket PZ 3/8", PZ.1, PZ.2, PZ.3
	82348055...08	3 Bit socket slotted 3/8", 5.5, 7, 8
	8264810...55	10 Bit socket TX 3/8", T10, T15, T20, T25, T27, T30, T40, T45, T50, T55
	- 7121502	1 Ratchet 3/8", 60 teeth
	- 7142075...250	2 Extension 3/8", 75, 250mmml
	- 71521	1 Universal joint 3/8"
	7171216...21	2 Spark plug socket 3/8", 16, 21
	- 71632	1 Adaptor 1/2"(F)x3/8"(M)

302801 - SOCKET SET 1/2", 28-PCS BMCS (SAE)



TOOLS	ART. NO.	CONTENTS
	23910...32	15 Flank socket 1/2", 12 pt. 3/8", 7/16", 1/2", 9/16", 5/8", 11/16", 3/4", 13/16", 7/8", 15/16", 1", 1.1/16", 1.1/8", 1.3/16", 1.1/4"
	834106206...17	8 Bit socket hex 1/2" 1/4", 9/32", 5/16", 11/32", 3/8", 7/16", 9/16", 5/8"
	- 7121503	1 Ratchet 1/2" 60 teeth
	- 7143125...250	2 Extension 1/2", 125, 250mmml
	- 71623	1 Adaptor 3/8"(F)x1/2"(M)
	- 71531	1 Universal joint 1/2"

303401 - SOCKET AND WRENCH SET 1/2", 34-PCS BMCS (SAE)



TOOLS	ART. NO.	CONTENTS
	23910...32	15 Flank socket 1/2" 12 pt. 3/8", 7/16", 1/2", 9/16", 5/8", 11/16", 3/4", 13/16", 7/8", 15/16", 1", 1.1/16", 1.1/8", 1.3/16", 1.1/4"
	- 7121503	1 Ratchet 1/2" 60 teeth
	- 7143125...250	2 Extension 1/2", 125, 250mmml
	- 71531	1 Universal joint 1/2"
	7171316...21	2 Spark plug socket 1/2", 16, 21
	- 71623	1 Adaptor 3/8"(F)x1/2"(M)
	- 4150206...24	12 Combination wrench 1/4", 5/16", 3/8", 7/16", 1/2", 9/16", 5/8", 11/16", 3/4", 13/16", 7/8", 15/16"

308502 - SOCKET SET 1/4" & 1/2", 85-PCS BMCS (SAE)

5984 GRAM



S403 - EMPTY BLOW MOULD CASE 240 X 120 X 45MM

386 GRAM



S404 - EMPTY BLOW MOULD CASE 280 X 150 X 45MM

554 GRAM



S407 - EMPTY BLOW MOULD CASE 340 X 220 X 60MM

936 GRAM



S409 - EMPTY BLOW MOULD CASE 380 X 250 X 65MM

1328 GRAM



S409-1 - EMPTY BLOW MOULD CASE 380 X 250 X 85MM

1256 GRAM



S413 - EMPTY BLOW MOULD CASE 440 X 310 X 75MM

1772 GRAM



TOOLS	ART. NO.	CONTENTS
	21905...13	9 Flank socket 1/4", 12 pt. 3/16", 7/32", 1/4", 9/32", 5/16", 11/32", 3/8", 7/16", 1/2"
	2195006...12	7 Flank deep socket 1/4", 12 pt. 1/4", 9/32", 5/16", 11/32", 3/8", 7/16", 1/2"
	81413703...06	4 Bit socket hex 1/4", 1/8", 5/32", 3/16", 7/32"
	8163708...30	7 Bit socket TX 1/4", T8, T10, T15, T20, T25, T27, T30
	8133704...65	3 Bit socket slotted 1/4", 4, 5.5, 6.5
	8113701...02	2 Bit socket PH 1/4", PH.1, PH.2
	8123701...02	2 Bit socket PZ 1/4", PZ.1, PZ.2
	7121501	1 Ratchet 1/4" 60 teeth
	7131115	1 Sliding T-handle 1/4"
	7141050...100	2 Extension 1/4", 50, 100mm
	71511	1 Universal joint 1/4"
	72401	1 Spinner 1/4", 150mm
	184-3	3 Hex key 1.5, 2, 2.5
	23910...32	15 Flank socket 1/2" 12 pt. 3/8", 7/16", 1/2", 9/16", 5/8", 11/16", 3/4", 13/16", 7/8", 15/16", 1", 1.1/16", 1.1/8", 1.3/16", 1.1/4"
	2397713...22	5 Flank deep socket 1/2" 12 pt. 1/2", 5/8", 11/16", 3/4", 7/8"
	7121503	1 Ratchet 1/2" 60 teeth
	7143125...250	2 Extension 1/2", 125, 250mm
	71531	1 Universal joint 1/2"
	7171316...21	2 Spark plug socket 1/2", 16, 21
	71623	1 Adaptor 3/8"(F)x1/2"(M)
	72032	1 Bit holder 1/2"(F)x5/16"(F)
	9243007...14	5 Bit hex 5/16" 30mm, 7, 8, 10, 12, 14mm
	9263040...55	4 Bit TX 5/16" 30mm, T40, T45, T50, T55
	9233008...12	3 Bit slotted 5/16" 30mm, 8, 10, 12mm
	9213003...04	2 Bit PH 5/16" 30mm, PH.3, PH.4
	9223003...04	2 Bit 5/16" 30mm, PZ.3, PZ.4



**WORK
EFFICIENT
WORK
WITH SONIC**

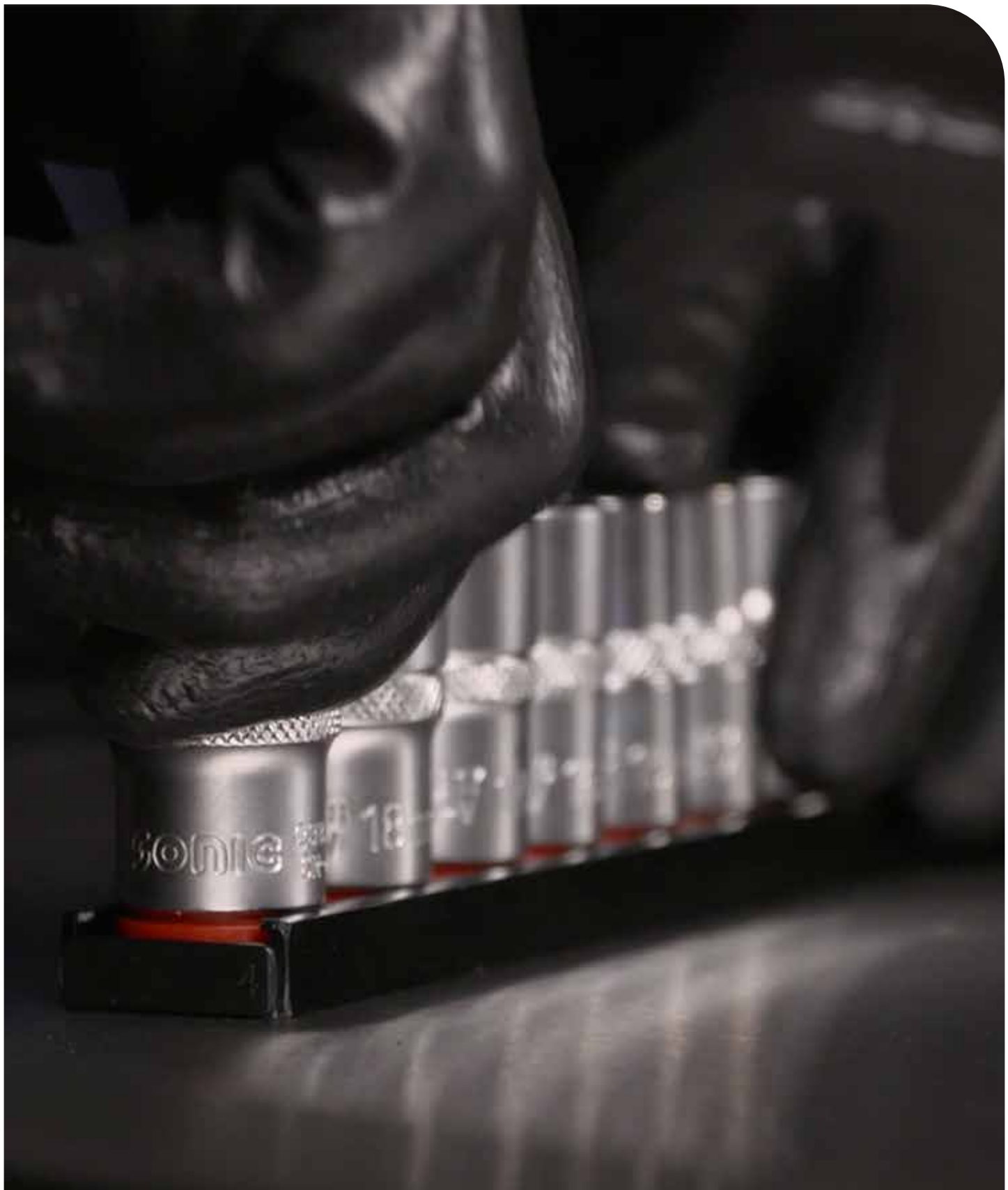

**WORK
EFFICIENT
WORK
WITH SONIC**



SONIC SOCKET RAILS

Sockets & bit sockets always perfectly organized.

05 > Sonic socket rails



> Sets 1/4"
PAGE 179



> Sets 3/8"
PAGE 180



> Sets 1/4" + 3/8"
PAGE 182



> Sets 1/2"
PAGE 182



> Sets universal
PAGE 183

101001 - FLANK SOCKET SET 1/4", 6 PT. ON RAIL 10-PCS

6.3
1/4"



TOOLS	ART. NO.	CONTENTS
	21505...13	Flank socket 1/4", 6 pt. 5, 5.5, 6, 7, 8, 9, 10, 11, 12, 13mm

101203 - FLANK SOCKET SET 1/4", 6 PT. ON RAIL 12-PCS

6.3
1/4"



TOOLS	ART. NO.	CONTENTS
	21504...13	Flank socket 1/4", 6 pt. 4, 4.5, 5, 5.5, 6, 7, 8, 9, 10, 11, 12, 13mm

101204 - FLANK DEEP SOCKET SET 1/4", 6 PT. ON RAIL 12-PCS

6.3
1/4"



TOOLS	ART. NO.	CONTENTS
	2155004...13	Flank deep socket 1/4", 6 pt. 4, 4.5, 5, 5.5, 6, 7, 8, 9, 10, 11, 12, 13mm

101201 - SOCKET SET 1/4", 12 PT. ON RAIL 12-PCS

6.3
1/4"



TOOLS	ART. NO.	CONTENTS
	21804...13	Socket 1/4", 12 pt. 4, 4.5, 5, 5.5, 6, 7, 8, 9, 10, 11, 12, 13mm

101202 - DEEP SOCKET SET 1/4", 12 PT. ON RAIL 12-PCS

6.3
1/4"

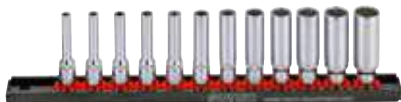

TOOLS	ART. NO.	CONTENTS
	2185004...13	Deep socket 1/4", 12 pt. 4, 4.5, 5, 5.5, 6, 7, 8, 9, 10, 11, 12, 13mm

100901 - DEEP SOCKET SET 1/4", 12 PT. ON RAIL 12-PCS

6.3
1/4"



TOOLS	ART. NO.	CONTENTS
	21905...13	Socket 1/4", 12 pt. 3/16", 7/32", 1/4", 9/32", 5/16", 11/32", 3/8", 7/16", 1/2"

100902 - DEEP SOCKET SET 1/4", 12 PT. ON RAIL 9-PCS

6.3
1/4"



TOOLS	ART. NO.	CONTENTS
	2195005...12	Deep socket 1/4", 12 pt. 3/16", 7/32", 1/4", 9/32", 5/16", 11/32", 3/8", 7/16", 1/2"

101002 - TX SOCKET SET 1/4", TX ON RAIL 10-PCS

6.3
1/4"



TOOLS	ART. NO.	CONTENTS
	21605...10	Socket TX 1/4", E5, E6, E7, E8, E10
	2165005...10	Deep socket TX 1/4", E5, E6, E7, E8, E10

101003 - BIT SOCKET SET 1/4", ON RAIL 10-PCS

6.3
1/4"



TOOLS	ART. NO.	CONTENTS
	8113701...02	Bit socket PH 1/4", PH.1, PH.2
	8123701...02	Bit socket PZ 1/4", PZ.1, PZ.2
	8143703...08	Bit socket hex 1/4", 3, 4, 5, 6, 7, 8mm

100904 - BIT SOCKET SET 1/4", HEX ON RAIL 9-PCS

6.3
1/4"



TOOLS	ART. NO.	CONTENTS
	8143703...10	Bit socket hex 1/4", 3, 4, 5, 5.5, 6, 7, 8, 9, 10mm

100903 - BIT SOCKET SET 1/4", HEX WITH BALL END ON RAIL 9-PCS

6.3
1/4"



TOOLS	ART. NO.	CONTENTS
	8103703...10	Bit socket hex ball 1/4", 3, 4, 5, 5.5, 6, 7, 8, 9, 10mm

100702 - BIT SOCKET SET 1/4", HEX ON RAIL 7-PCS

6.3
1/4"



TOOLS	ART. NO.	CONTENTS
	81413703...10	Bit socket hex 1/4", 1/8", 5/32", 3/16", 7/32", 1/4", 5/16", 3/8"

Sonic socket rails

101004 - BIT SOCKET SET 1/4", TX ON RAIL 10-PCS

6.3
1/4"



TOOLS	ART. NO.	CONTENTS
	8163708...25	Bit socket TX 1/4", T8, T10, T15, T20, T25
	8173708...25	Bit socket TX tamperproof 1/4", T8H, T10H, T15H, T20H, T25H

100704 - BIT SOCKET SET 1/4", TX WITH BALL END ON RAIL 7-PCS

6.3
1/4"



TOOLS	ART. NO.	CONTENTS
	81613710...40	Bit socket TX ball 1/4", T10, T15, T20, T25, T27, T30, T40

100701 - BIT SOCKET SET 1/4", TX TAMPERPROOF ON RAIL 7-PCS

6.3
1/4"



TOOLS	ART. NO.	CONTENTS
	8153710...40	Tamper-resistant 1/4", TX plus (5 lobes) 10IPR, 15IPR, 20IPR, 25IPR, 27IPR, 30IPR, 40IPR

101005 - BIT SOCKET SET 1/4", TX TAMPERPROOF ON RAIL 10-PCS

6.3
1/4"



TOOLS	ART. NO.	CONTENTS
	8153708...50	Tamper-resistant 1/4", TX plus (5 lobes) 8IPR, 10IPR, 15IPR, 20IPR, 25IPR, 27IPR, 30IPR, 40IPR, 45IPR, 50IPR

100501 - BIT SOCKET SET 1/4", SPLINE ON RAIL 5-PCS

6.3
1/4"



TOOLS	ART. NO.	CONTENTS
	8183704...10	Bit socket spline 1/4", M4, M5, M6, M8, M10

100601 - BIT SOCKET SET 1/4", RIBE ON RAIL 6-PCS

6.3
1/4"



TOOLS	ART. NO.	CONTENTS
	8193704...10	Bit socket ribe 1/4", M4, M5, M6, M7, M8, M10

201001 - SOCKET SET 3/8", 6 PT. ON RAIL 10-PCS

10
3/8"



TOOLS	ART. NO.	CONTENTS
	22508...17	Flank socket 3/8", 6 pt. 8, 9, 10, 11, 12, 13, 14, 15, 16, 17mm

201008 - FLANK DEEP SOCKET 3/8", 6 PT. ON RAIL 10-PCS

10
3/8"



TOOLS	ART. NO.	CONTENTS
	2256308...17	Flank deep socket 3/8", 6 pt. 8, 9, 10, 11, 12, 13, 14, 15, 16, 17mm

201009 - SOCKET SET 3/8", 12 PT. ON RAIL 10-PCS

10
3/8"



TOOLS	ART. NO.	CONTENTS
	22808...19	Socket 3/8", 12 pt. 8, 10, 11, 12, 13, 14, 15, 16, 17, 19mm

201010 - DEEP SOCKET SET 3/8", 12 PT. ON RAIL 10-PCS

10
3/8"



TOOLS	ART. NO.	CONTENTS
	2286308...19	Deep socket 3/8", 12 pt. 8, 10, 11, 12, 13, 14, 15, 16, 17, 19mm

200801 - SOCKET SET 3/8", 12 PT. ON RAIL 8-PCS

10
3/8"



TOOLS	ART. NO.	CONTENTS
	22910...21	Socket 3/8", 12 pt. 3/8", 7/16", 1/2", 9/16", 5/8", 11/16", 3/4", 13/16"

200802 - DEEP SOCKET SET 3/8", 12 PT. ON RAIL 8-PCS

10
3/8"



TOOLS	ART. NO.	CONTENTS
	2296310...21	Socket 3/8", 12 pt. deep 3/8", 7/16", 1/2", 9/16", 5/8", 11/16", 3/4", 13/16"

201002 - SOCKET SET 3/8", TX ON RAIL 10-PCS



10
3/8"

TOOLS	ART. NO.	CONTENTS
	22610...16	Socket TX 3/8", E10, E11, E12, E14, E16
	2266310...16	Deep socket TX 3/8", E10, E11, E12, E14, E16

201014 - CARDAN SOCKET SET 3/8", 12 PT. ON RAIL 10-PCS



10
3/8"

TOOLS	ART. NO.	CONTENTS
	7152810...19	Cardan socket 3/8" 10, 11, 12, 13, 14, 15, 16, 17, 18, 19mm

200907 - HEX LOW SOCKET BIT SET 3/8", ON RAIL 9-PCS



10
3/8"

TOOLS	ART. NO.	CONTENTS
	8242704...12	Hex low socket bit set 3/8" 4, 5, 6, 7, 8, 9, 10, 11, 12mm

201003 - BIT SOCKET SET 3/8", HEX ON RAIL 10-PCS



10
3/8"

TOOLS	ART. NO.	CONTENTS
	8244803...12	Bit socket hex 3/8", 3, 4, 5, 5.5, 6, 7, 8, 9, 10, 12mm

200903 - HEX LONG BIT SOCKET SET 3/8", HEX ON RAIL 9-PCS



10
3/8"

TOOLS	ART. NO.	CONTENTS
	8249003...10	Bit socket hex 3/8", 90mm 3, 4, 5, 5.5, 6, 7, 8, 9, 10mm

200901 - BIT SOCKET HEX BALL SET 3/8", HEX WITH BALL ON RAIL 9-PCS



10
3/8"

TOOLS	ART. NO.	CONTENTS
	8209003...10	Bit socket hex ball 3/8", 3, 4, 5, 5.5, 6, 7, 8, 9, 10mm

200902 - BIT SOCKET HEX SET 3/8", HEX ON RAIL 9-PCS



10
3/8"

TOOLS	ART. NO.	CONTENTS
	82414803...13	Bit socket hex 3/8", 1/8", 5/32", 3/16", 7/32", 1/4", 5/16", 3/8", 7/16", 1/2"

201016 - STAR LOW SOCKET BIT SET 3/8", ON RAIL 10-PCS



10
3/8"

TOOLS	ART. NO.	CONTENTS
	8262710...55	Star low socket bit set 3/8" T10, T15, T20, T25, T27, T30, T40, T45, T50, T55

201005 - BIT SOCKET SET 3/8", TX ON RAIL 10-PCS



10
3/8"

TOOLS	ART. NO.	CONTENTS
	8264808...50	Bit socket TX 3/8" T8, T10, T15, T20, T25, T27, T30, T40, T45, T50

201012 - BIT SOCKET SET 3/8", TX LONG ON RAIL 10-PCS



10
3/8"

TOOLS	ART. NO.	CONTENTS
	8269008...50	Bit socket TX 3/8", 90mm T8, T10, T15, T20, T25, T27, T30, T40, T45, T50

201006 - BIT SOCKET SET 3/8", TX TAMPERPROOF ON RAIL 10-PCS



10
3/8"

TOOLS	ART. NO.	CONTENTS
	8274808...50	Bit socket TX tamperproof 3/8", T8H, T10H, T15H, T20H, T25H, T27H, T30H, T40H, T45H, T50H

201013 - BIT SOCKET SET 3/8", TX TAMPERPROOF LONG ON RAIL 10-PCS



10
3/8"

TOOLS	ART. NO.	CONTENTS
	8279008...50	Bit socket TX tamperproof 3/8", 90mm T8H, T10H, T15H, T20H, T25H, T27H, T30H, T40H, T45H, T50H

Sonic socket rails

201201 - BIT SOCKET SET 3/8", RIBE & SPLINE ON RAIL 12-PCS

10
3/8"



TOOLS	ART. NO.	CONTENTS
	8284805...12	Bit socket spline 3/8", M5, M6, M8, M9, M10, M12
	8294805...10	Bit socket ribe 3/8", M5, M6, M7, M8, M9, M10

200805 - 1/4" & 3/8" PORSCHE SOCKETS 10MM ON RAIL 8-PCS

6.3
1/4" 10
3/8"



TOOLS	ART. NO.	CONTENTS
	21510	Flank socket 1/4" 6 pt. 10mm
	2155010	Flank deep socket 1/4" 6 pt. 10mm
	22510	Flank socket 3/8" 6 pt. 10mm
	2256310	Flank deep socket 3/8" 6 pt. 10mm
	71511	Universal joint 1/4"
	7151810	Cardan socket 1/4" 12 pt. 10mm
	71521	Universal joint 3/8"
	7152810	Cardan socket 3/8", 10mm

201015 - 1/4" & 3/8" VW/AUDI SOCKET SET ON RAIL 10-PCS

6.3
1/4" 10
3/8"



TOOLS	ART. NO.	CONTENTS
	21510...13	Flank socket 1/4" 6 pt. 10, 13mm
	8163720...30	Bit socket TX 1/4", T20, T25, T30
	8244805...06	Bit socket hex 3/8", 5, 6mm
	8284806...10	Bit socket spline 3/8" M6, M8, M10

301201 - FLANK SOCKET SET 1/2", 6 PT. ON RAIL 12-PCS

12.5
1/2"



TOOLS	ART. NO.	CONTENTS
	23508...19	Flank socket 1/2", 6 pt. 8, 9, 10, 11, 12, 13, 14, 15, 16, 17, 18, 19mm

301007 - FLANK SOCKET SET 1/2", 6 PT. ON RAIL 10-PCS

12.5
1/2"



TOOLS	ART. NO.	CONTENTS
	23510...24	Flank socket 1/2", 6 pt. 10, 11, 12, 13, 14, 15, 17, 19, 21, 24mm

301202 - FLANK DEEP SOCKET SET 1/2", 6 PT. ON RAIL 12-PCS

12.5
1/2"



TOOLS	ART. NO.	CONTENTS
	2357708...19	Flank deep socket 1/2", 6 pt. 8, 9, 10, 11, 12, 13, 14, 15, 16, 17, 18, 19mm

301203 - SOCKET SET 1/2", 12 PT. ON RAIL 12-PCS

12.5
1/2"



TOOLS	ART. NO.	CONTENTS
	23808...19	Socket 1/2", 12 pt. 8, 9, 10, 11, 12, 13, 14, 15, 16, 17, 18, 19mm

301204 - DEEP SOCKET SET 1/2", 12 PT. ON RAIL 12-PCS

12.5
1/2"



TOOLS	ART. NO.	CONTENTS
	2387708...19	Deep socket 1/2", 12 pt. 8, 9, 10, 11, 12, 13, 14, 15, 16, 17, 18, 19mm

301503 - SOCKET SET 1/2", 12 PT. ON RAIL 15-PCS

12.5
1/2"



TOOLS	ART. NO.	CONTENTS
	23910...32	Socket 1/2", 12 pt. 3/8", 7/16", 1/2", 9/16", 5/8", 11/16", 3/4", 13/16", 7/8", 15/16", 1", 1.1/16", 1.1/8", 1.3/16", 1.1/4"

301504 - DEEP SOCKET SET 1/2", 12 PT. ON RAIL 15-PCS

12.5
1/2"



TOOLS	ART. NO.	CONTENTS
	2397710...32	Deep socket 1/2", 12 pt. 3/8", 7/16", 1/2", 9/16", 5/8", 11/16", 3/4", 13/16", 7/8", 15/16", 1", 1.1/16", 1.1/8", 1.3/16", 1.1/4"

300902 - SOCKET SET 1/2", TX ON RAIL 9-PCS

12.5
1/2"



TOOLS	ART. NO.	CONTENTS
	23610...24	Socket TX 1/2", E10, E11, E12, E14, E16, E18, E20, E22, E24

300903 - DEEP SOCKET SET 1/2", TX ON RAIL 9-PCS

12.5
1/2"



TOOLS	ART. NO.	CONTENTS
	2367710...24	Deep TX socket 1/2", E10, E11, E12, E14, E16, E18, E20, E22, E24

301003 - BIT SOCKET SET 1/2", HEX ON RAIL 10-PCS

12.5
1/2"



TOOLS	ART. NO.	CONTENTS
	83406204...14	Bit socket hex 1/2", 4, 5, 5.5, 6, 7, 8, 9, 10, 12, 14mm

301002 - BIT SOCKET SET 1/2", HEX ON RAIL 10-PCS

12.5
1/2"



TOOLS	ART. NO.	CONTENTS
	834106205...17	Bit socket hex 1/2", 3/16", 1/4", 9/32", 5/16", 11/32", 3/8", 7/16", 1/2", 9/16", 5/8"

301005 - BIT SOCKET SET 1/2", TX ON RAIL 10-PCS

12.5
1/2"



TOOLS	ART. NO.	CONTENTS
	83606220...70	Bit socket TX 1/2", T20, T25, T27, T30, T40, T45, T50, T55, T60, T70

301006 - BIT SOCKET SET 1/2", TX TAMPERPROOF ON RAIL 10-PCS

12.5
1/2"



TOOLS	ART. NO.	CONTENTS
	83706220...70	Bit socket TX tamperproof 1/2", T20H, T25H, T27H, T30H, T40H, T45H, T50H, T55H, T60H, T70H

300906 - BIT SOCKET SET 1/2", SPLINE ON RAIL 9-PCS

12.5
1/2"



TOOLS	ART. NO.	CONTENTS
	83806205...16	Bit socket spline 1/2", M5, M6, M8, M9, M10, M12, M14, M16
	83806216T	Bit socket spline 1/2", M16-T

301008 - BIT SOCKET SET 1/2", RIBE ON RAIL 10-PCS

12.5
1/2"



TOOLS	ART. NO.	CONTENTS
	83906205...14	Bit socket ribe 1/2", M5, M6, M7, M8, M9, M10, M10-1, M12, M13, M14

300308 - UNIVERSAL JOINT 3-PCS



ART. NO.	CONTENTS
300308-1	Universal joint 1/4"
300308-2	Universal joint 3/8"
300308-3	Universal joint 1/2"

300814 - ADAPTOR & UNIVERSAL JOINT 8-PCS



ART. NO.	CONTENTS
72011	Bit holder 1/4"[F] x 1/4"[F]
71912	Adaptor 1/4"[F] X 3/8"[M]
71511	Universal joint 1/4"
71921	Adaptor 3/8"[F] x 1/4"[M]
71923	Adaptor 3/8"[F] X 1/2"[M]
71521	Universal joint 3/8"
71932	Adaptor 1/2"[F] x 3/8"[M]
71531	Universal joint 1/2"



SONIC TOOL SETS

A wide variety of tool sets that will improve your productivity.

Sonic tool sets

602006 - SCREWDRIVER SET IN COLORED BOX, 20-PCS



ART. NO.	PCS	CONTENTS
1311...3	3	Screwdriver PH, PH.1, PH.2, PH.3
1312S	1	Screwdriver stubby PH, PH.2
1321...3	3	Screwdriver PZ, PZ.1, PZ.2, PZ.3
1322S	1	Screwdriver stubby PZ, PZ.2
13303...8	5	Screwdriver slotted, 3, 4, 5.5, 6.5, 8mm
133065S	1	Screwdriver stubby slotted, 6.5mm
13610...30	6	Screwdriver TX, T10, T15, T20, T25, T27, T30

600618 - SCREWDRIVER SET IN COLORED BOX, 6-PCS



ART. NO.	PCS	CONTENTS
1311...12	2	Screwdriver PH, PH.1, PH.2
13303...65	4	Screwdriver slotted, 3, 4, 5.5, 6.5mm

06

600514 - GO-THROUGH SCREWDRIVER SET IN COLORED BOX, 5-PCS



ART. NO.	PCS	CONTENTS
15101...2	2	Hammer go-through screwdriver PH, PH.1, PH.2
1530155...08	3	Hammer go-through screwdriver slotted, 5.5, 6.5, 8mm

600619 - SCREWDRIVER SET TX IN COLORED BOX, 6-PCS



ART. NO.	PCS	CONTENTS
13610...30	6	Screwdriver TX, T10, T15, T20, T25, T27, T30

600512 - SCREWDRIVER SET IN COLORED BOX, 5-PCS



ART. NO.	PCS	CONTENTS
1311...2	2	Screwdriver PH, PH.1, PH.2
13304...65	3	Screwdriver slotted, 4, 5.5, 6.5mm

600620 - SCREWDRIVER SET TX-H IN COLORED BOX, 6-PCS



ART. NO.	PCS	CONTENTS
13710...30	6	Screwdriver TX tamperproof, T10H, T15H, T20H, T25H, T27H, T30H

Sonic tool sets

601001 - 16 IN 1 RATCHET SCREWDRIVER



ART. NO.	PCS	CONTENTS
601001-1	1	Ratchet grip
601001-2	1	Bit holder
601001-3	1	Bit PH.1+PH.2
601001-4	1	Bit PZ.1+PZ.2
601001-5	1	Bit slotted 3.5mm + 5mm
601001-6	1	Bit 1/4"
601001-7	1	Bit T10+T15
601001-8	1	Bit T20+T25
601001-9	1	Bit T27+T30
601001-10	1	Bit hex 3mm+4mm

602303 - PRECISION SCREWDRIVER SET, 23-PCS

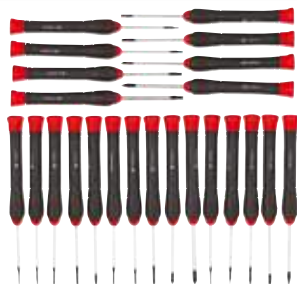

ART. NO.	PCS	CONTENTS
602303-1...5	5	Screwdriver PH, PH.0000, PH.000, PH.00, PH.0, PH.1
602303-6...7	2	Screwdriver PZ, PZ.0, PZ.1
602303-8...12	5	Screwdriver slotted, 1.5, 2, 2.5, 3, 3.5mm
602303-13...16	4	Screwdriver hex, 1.5, 2, 2.5, 3mm
602303-17...23	7	Screwdriver TX, T5, T6, T7, T8, T9, T10, T15

601503 - IMPACT DRIVER SET, 15-PCS



ART. NO.	PCS	CONTENTS
72501	1	Impact driver
9243604...08	4	Bit hex 5/16" 36mm, 4, 5, 6, 8mm
9233605...12	5	Bit slotted 5/16" 36mm, 5, 6, 8, 10, 12mm
9213601...04	4	Bit PH 5/16" 36mm, PH.1, PH.2, PH.3, PH.4
72032	1	Bit holder 1/2"(F) x 5/16"(F)

101007 - BIT SET 1/4", 10-PCS



PCS	CONTENTS
2	Bit PH.1, PH.2
2	Bit slotted 5.5, 6.5mm
6	Bit T10, T15, T20, T25, T27, T30

600919 - POCKET BITS, 9-PCS



103101 - BIT SET 1/4", 31-PCS



ART. NO.	PCS	CONTENTS
103101-1	1	Ratchet 1/4"
103101-2...4	3	Bit PH.1, PH.2, PH.3
103101-5...7	3	Bit PZ.1, PZ.2, PZ.3
103101-8...12	5	Bit slotted, 3.5, 4.5, 5.5, 6.5, 8mm
103101-13...19	7	Bit hex, 2, 3, 4, 5, 6, 7, 8mm
103101-20...29	10	Bit TX, T7, T8, T9, T10, T15, T20, T25, T27, T30, T40
103101-30...31	2	Bit robertson, R1, R2

103201 - BIT SET, 32-PCS



PCS	CONTENTS
1	Bit holder 1/4"(F)x1/4"(M) 65mm
1	Bit adaptor 1/4"(F)x1/4"(F) 25mm
4	Bit slotted 1/4" 25mm, 3, 4, 5.5, 6.5mm
4	Bit PH 1/4" 25mm, PH.1, PH.2, PH.3, PH.4
4	Bit PZ 1/4" 25mm, PZ.1, PZ.2, PZ.3, PZ.4
6	Bit hex 1/4" 25mm, 2, 2.5, 3, 4, 5, 6mm
6	Bit TX 1/4" 25mm, T10, T15, T20, T25, T30, T40
6	Bit TX tamperproof 1/4" 25mm, T10H, T15H, T20H, T25H, T30H, T40H

829136 - WHEEL NUT KEY SET - AUDI, 22-PCS



- 1/4" or 12mm
- Sockets are manufactured from chrome vanadium
- 1/4" with locking ring for use with supplied ratchet spanner
- Bits made from SNCM-V
- Ideal for car door hinges and for use where space is restricted

PCS	CONTENTS
4	7, 8, 10, 12mm
6	Hex 4, 5, 6, 7, 8, 10mm
5	TX T27, T30, T40, T45, T50
4	Spline M5, M6, M8, M10
1	12mm Bi-Hex ratchet spanner

601906 - FLEXIBLE HOSE CLIP DRIVER SET, 19-PCS

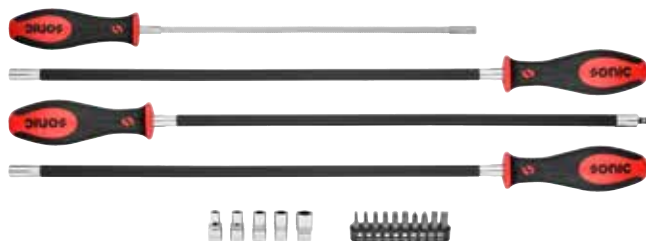

ART. NO.	PCS	CONTENTS
72403	1	Long flexible spinner 1/4" 545mml
4753701	1	Flexible Socket screwdriver, Hex 7mm 545mml
72001	1	Long flexible magnetic bit holder 1/4", 545mml
21505...10	5	Flank socket 1/4", 6 pt. 5, 6, 7, 8, 10mm
-	2	Bit PH.1, PH.2
-	2	Bit slotted 5.5, 6.5mm
-	6	Bit T10, T15, T20, T25, T27, T30

100602 - MINI RATCHET SET, 6-PCS



PCS	CONTENTS
1	Bit ratchet handle for 10mm Hex bit
1	Bit ratchet handle for 5/16" Hex bit
1	Bit ratchet handle for 1/4" Hex bit
1	Adaptor Hex 10mm - 3/8"
1	Adaptor Hex 5/16" - 3/8"
1	Adaptor Hex 1/4" - 1/4"

102801 - 1/4" SOCKET & BIT SET, 28-PCS



101901 - DISC RATCHET SET 1/4", 19-PCS



ART. NO.	PCS	CONTENTS
21506...12	5	Flank socket 1/4", 6 pt. 6, 8, 9, 10, 12mm
7110301	1	Disc ratchet 1/4", 72 teeth
7141050	1	Extension 1/4" 50mml
72011	1	Bit holder 1/4"(F) x 1/4"(F)
9112501...03	3	Bit PH 1/4" 25mml, PH.1, PH.2, PH.3
9132503...06	4	Bit slotted 1/4" 25mml, 3, 4, 5, 6mm
9142503...05	3	Bit hex 1/4" 25mml, 3, 4, 5mm

75214 - SOCKET & BIT SET 1/4", 36-PCS



PCS	CONTENTS
1	Flat ratcheting wrench 11mm
1	Bit holder 1/4"(F) x 1/4"(F)
1	Extension 1/4", 50mml
4	Bit 1/4", 25mml PH.0, PH.1, PH.2, PH.3
3	Bit 1/4", slotted 25mml 4, 5, 6mm
6	Bit 1/4", hex 25mml 2, 2.5, 3, 4, 5, 6mm
7	Bit 1/4", 25mml, T10, T15, T20, T25, T27, T30, T40
13	Multi grip socket 1/4", 4, 4.5, 5, 5.5, 6, 7, 8, 9, 10, 11, 12, 13, 14mm

Sonic tool sets

605003 - VDE TOOLSET, 50-PCS



A comprehensive 50 piece insulated tool set - 1000V, VDE & GS certified.

PCS	CONTENTS
3	Screwdrivers: PH.1 x 80mm, PH.2 x 100mm, PH.2 x 150mm
4	Screwdrivers: Slotted: 2.5 x 75mm, 3 x 100mm, 3.5 x 100mm, 4 x 100mm
3	Screwdrivers: TX: T20 x 100mm, T25 x 125mm, T30 x 150mm
17	3/8" Socket set: 6, 7, 8, 9, 10, 11, 12, 13, 14, 15, 16, 17, 18, 19, 20, 21, 22mm
2	3/8" Extensions: 150, 250mm
1	3/8" Ratchet
3	Spline bits: M8, M10, M12
7	Pliers set: cable shears, bent nose pliers, long nose pliers, flat nose pliers, side cutters, water pump pliers and an insulated cable stripping knife
10	Protective 100mm sleeves: 5 x 18mm and 5 x 24mm

104601 - BIT SOCKET SET 1/4", 46-PCS



ART. NO.	PCS	CONTENTS
21504...14	13	Flank socket 1/4", 6 pt. 4, 4.5, 5, 5.5, 6, 7, 8, 9, 10, 11, 12, 13, 14mm
8143703...08	6	Bit socket hex 1/4", 3, 4, 5, 6, 7, 8mm
8163710...40	6	Bit socket TX 1/4", T10, T15, T20, T25, T30, T40
8133704...065	3	Bit socket slotted 1/4", 4, 5.5, 6.5mm
8113701...03	3	Bit socket PH 1/4", PH.1, PH.2, PH.3
8123701...03	3	Bit socket PZ 1/4", PZ.1, PZ.2, PZ.3
7120201	1	Ratchet 1/4" 24 teeth
7131115	1	Sliding T-handle 1/4"
7141050...100	2	Extension 1/4" 50mm, 100mm
71511	1	Universal joint 1/4"
7191125	1	Adaptor bit 1/4" hex-1/4" square 25mm
72401	1	Spinner 1/4" 150mm
7211	1	Flexible extension 1/4"
184-3	3	Hex key wrench 1.5, 2, 2.5mm

601020 - VDE SLIM INSULATE SCREWDRIVER SET, 10-PCS



PCS	CONTENTS
8	PH.1, PH.2, PZ.1, PZ.2, 3.5, 4, 5.5, 6.5

402001 - SOCKET SET 3/4", 12 PT. 20-PCS



ART. NO.	PCS	CONTENTS
24919...50	16	Socket 3/4", 12 pt. 19, 21, 22, 23, 24, 26, 27, 29, 30, 32, 35, 36, 38, 41, 46, 50mm
7121204	1	Ratchet 3/4" 24 teeth
7134450	1	Sliding T-handle 3/4"
7144100...200	2	Extension 3/4" 100mm, 200mm

501401 - SOCKET SET 1", 12 PT. 15-PCS



ART. NO.	PCS	CONTENTS
25836...80	10	Socket 1", 12 pt. 36, 41, 46, 50, 55, 60, 65, 70, 75, 80mm
7121205	1	Ratchet 1" 24 teeth
7135550	1	Sliding T-handle 1"
7135	1	Sliding T-handle 1" head
7145200...400	2	Extension 1" 200mm, 400mm

301601 - MULTI FUNCTION SOCKET SET 1/2", 16-PCS

Sizes 8 - 24mm. The Sonic multi grip socket set is a new design. Now instead of 4 sockets, 1 Sonic multi grip socket will do the trick. The profile of the multi grip socket is capable of removing and tightening: - metric, hex, TX, square, SAE

ART. NO.	MULTI GRIP SOCKET	HEX MM	HEX INCH	STAR	SQUARE MM	SQUARE INCH	12 PT. MM	12 PT. INCH
301601-1	8	8	5/16"	E10	7	9/32"	8	5/16"
301601-2	9	9	11/32"	-	8	5/16"	9	11/32"
301601-3	10	10	3/8"	E12	9	11/32"	10	3/8"
301601-4	11	11	7/16"	E14	10	3/8"	11	7/16"
301601-5	12	12	15/32"	E16	-	-	12	15/32"
301601-6	13	13	1/2"	-	11	7/16"	13	1/2"
301601-7	14	14	9/16"	E18	12	15/32"	14	9/16"
301601-8	15	15	19/32"	-	13	1/2"	15	19/32"
301601-9	16	16	5/8"	E20	14	9/16"	16	5/8"
301601-10	17	17	11/16"	-	15	-	17	11/16"
301601-11	18	18	23/32"	E22	-	-	18	23/32"
301601-12	19	19	3/4"	E24	16	5/8"	19	3/4"
301601-13	20	20	25/32"	-	17	11/16"	20	25/32"
301601-14	21	21	13/16"	-	18	23/32"	21	13/16"
301601-15	22	22	7/8"	-	19	3/4"	22	7/8"
301601-16	24	24	15/16"	-	21	13/16"	24	15/16"

300603 - ADAPTOR SET, 6-PCS

ART. NO.	PCS	CONTENTS
71912	1	Adaptor 1/4"(F) x 3/8"(M)
71921	1	Adaptor 3/8"(F) x 1/4"(M)
71923	1	Adaptor 3/8"(F) x 1/2"(M)
71932	1	Adaptor 1/2"(F) x 3/8"(M)
71934	1	Adaptor 1/2"(F) x 3/4"(M)
71943	1	Adaptor 3/4"(F) x 1/2"(M)

300605 - IMPACT ADAPTOR SET, 6-PCS

ART. NO.	PCS	CONTENTS
73612	1	Impact adaptor 1/4"(F) x 3/8"(M)
73621	1	Impact adaptor 3/8"(F) x 1/4"(M)
73623	1	Impact adaptor 3/8"(F) x 1/2"(M)
73632	1	Impact adaptor 1/2"(F) x 3/8"(M)
73634	1	Impact adaptor 1/2"(F) x 3/4"(M)
73643	1	Impact adaptor 3/4"(F) x 1/2"(M)

304201 - BIT SET 10MM, 42-PCS

06

Note: Certain T40 TX fasteners are glued into place with Loctite. This glue must be melted with a hot air gun before attempting to remove the bolt or damage may result to the T40 TX bit.

ART. NO.	PCS	CONTENTS
9343004...12	7	Bit hex 10mm 30mm, 4, 5, 6, 7, 8, 10, 12mm
9347504...12	7	Bit hex 10mm 75mm, 4, 5, 6, 7, 8, 10, 12mm
9363020...60	8	Bit TX 10mm 30mm, T20, T25, T30, T40, T45, T50, T55, T60
9367520...60	8	Bit TX 10mm 75mm, T20, T25, T30, T40, T45, T50, T55, T60
9383005...12	5	Bit spline 10mm 30mm, M5, M6, M8, M10, M12
9387505...12	5	Bit spline 10mm 75mm, M5, M6, M8, M10, M12
72023...33	2	Bit holder 3/8"(F) x 10mm(F), 1/2"(F) x 10mm(F)

Sonic tool sets

807001 - HUB NUT IMPACT SOCKET SET 1/2", 12-PT. 3-PCS



- A set of three thin walled, bi-hex impact sockets specifically designed for front hub nuts
 - Manufactured from Chrome Molybdenum [CR-MO]

ART. NO.	PCS	CONTENTS
807001-1	1	Hub nut impact socket 1/2", 12 pt. 30mm
807001-2	1	Hub nut impact socket 1/2", 12 pt. 32mm
807001-3	1	Hub nut impact socket 1/2", 12 pt. 36mm

300910 - IMPACT DEEP E SOCKET SET 1/2", 9-PCS



ART. NO.	PCS	CONTENTS
3367810...24	9	Impact deep socket 1/2", TX 78mm E10, E11, E12, E14, E16, E18, E20, E22, E24

300601 - IMPACT BIT SOCKET SET 1/2", 6-PCS



- 3 thin walled bi-hex impact sockets specifically designed for front hub nuts
 - Manufactured from Chrome Molybdenum [CR-MO]

SIZES	PCS	CONTENTS
Bit sockets 43mm	3	M14, M16, M18
Bit sockets 78mm	3	M14, M16, M18

601401 - COMBINATION WRENCH SET IN POUCH, 14-PCS



ART. NO.	PCS	CONTENTS
41506...22	14	Combination wrench 6, 7, 8, 9, 10, 11, 12, 13, 14, 15, 16, 17, 19, 22mm

602603 - COMBINATION WRENCH SET IN POUCH, 26-PCS

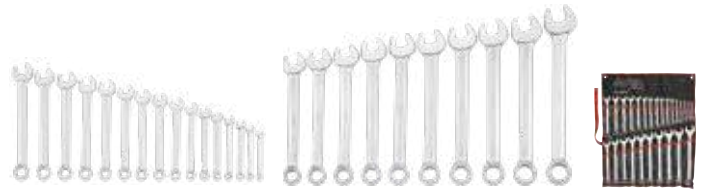

ART. NO.	PCS	CONTENTS
41506...32	26	Combination wrench 6, 7, 8, 9, 10, 11, 12, 13, 14, 15, 16, 17, 18, 19, 20, 21, 22, 23, 24, 25, 26, 27, 28, 29, 30, 32mm

601204 - COMBINATION WRENCH SET (SAE) 12-PCS



ART. NO.	PCS	CONTENTS
4150206...24	12	Combination wrench 1/4", 5/16", 3/8", 7/16", 1/2", 9/16", 5/8", 11/16", 3/4", 13/16", 7/8", 15/16"

600806 - DOUBLE OPEN WRENCH SET (SAE), 8-PCS



ART. NO.	PCS	CONTENTS
4220608...2932	8	Double open wrench 1/4"x5/16", 3/8"x7/16", 1/2"x9/16", 5/8"x11/16", 11/16"x3/4", 13/16"x7/8", 15/16"x1", 1.1/8"x1.1/4"

601702 - COMBINATION WRENCH SET IN POUCH, 17-PCS



ART. NO.	PCS	CONTENTS
41506...22	17	Combination wrench 6, 7, 8, 9, 10, 11, 12, 13, 14, 15, 16, 17, 18, 19, 20, 21, 22mm

600402 - FLARE NUT WRENCH SET (SAE), 4-PCS



ART. NO.	PCS	CONTENTS
4250608...1617	4	Flare nut wrench 1/4"x5/16", 3/8"x7/16", 1/2"x9/16", 5/8"x11/16"

600701 - 45° OFFSET RING WRENCH SET (SAE), 7-PCS



ART. NO.	PCS	CONTENTS
4270608...2425	7	45° offset ring wrench 1/4"x5/16", 3/8"x7/16", 1/2"x9/16", 9/16"x5/8", 11/16"x3/4", 13/16"x7/8", 15/16"x1"

600507 - FLEXIBLE FLARE NUT WRENCH SET, 5-PCS



ART. NO.	PCS	CONTENTS
40808...12	5	Flexible flare nut wrench 8, 9, 10, 11, 12mm

600203 - 4-IN-1 RATCHETING WRENCH SET IN POUCH, 2-PCS



ART. NO.	DESCRIPTION	L(MM)	B1(MM)	B2(MM)	A1(MM)	A2(MM)	G	PCS/BAG
4170401	4-in-1 ring ratcheting wrench 8-10, 12-13	160	21.5	26.5	8.9	9.8	98	5
4170402	4-in-1 ring ratcheting wrench 16-17, 18-19	230	34.5	35.6	11.7	12.2	264	5

601219 - REVERSIBLE RATCHETING WRENCH 12 PT. SET IN POUCH, 12-PCS



ART. NO.	PCS	CONTENTS
4170208...19	12	Reversible ratcheting wrench 12 pt. 8, 9, 10, 11, 12, 13, 14, 15, 16, 17, 18, 19mm

601218 - FLEXIBLE RATCHETING WRENCH 12 PT. SET IN POUCH, 12-PCS



ART. NO.	PCS	CONTENTS
4170308...19	12	Flexible ratcheting wrench 12 pt. 8, 9, 10, 11, 12, 13, 14, 15, 16, 17, 18, 19mm



SONIC SPECIAL TOOLS

Tools & tool sets for special projects
and services.

07 > Sonic special tools

- 

> Pry bars
PAGE 195



> Test and measuring sets
PAGE 215
- 

> Interior removal sets
PAGE 195



> Puller sets
PAGE 217
- 

> Crimping pliers
PAGE 197

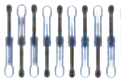

> Terminal release tool sets
PAGE 218
- 

> Hose line clamps
PAGE 198



> Tie raps
PAGE 219
- 

> Glow plug
PAGE 199



> Gloves
PAGE 219
- 

> Wheel sockets
PAGE 200



> Assortments
PAGE 222
- 

> Spiral sockets
PAGE 201



> Spring compressors
PAGE 227
- 

> Bolt twister socket sets
PAGE 202



> Jacks
PAGE 231
- 

> Drain plug key sets
PAGE 203



> Cable reels
PAGE 234
- 

> Alternator sets
PAGE 204



> Lights
PAGE 236
- 

> Oil filter sets
PAGE 206



> Boosters
PAGE 243
- 

> Brake caliper sets
PAGE 208



> Propulsions
PAGE 248
- 

> Heat guns
PAGE 211



> Battery chargers
PAGE 251
- 

> Ball joint separators
PAGE 212

Sonic special tools

600439 - MINI HOOK SET, 4-PCS



ART. NO.	PCS	DESCRIPTION
47829	1	Mini straight pick hook
47830	1	Mini degree hook
47831	1	Mini full hook
47832	1	Mini small angle hook

600437 - HOOK SET, 4-PCS



ART. NO.	PCS	DESCRIPTION
47909	1	Straight pick hook
47910	1	Degree hook
47911	1	Full hook
47912	1	Small angle hook

601014 - HEX KEY WRENCH SET 3 TIP T-HANDLE, 10-PCS



ART. NO.	DESCRIPTION
4840102...10	2, 2.5, 3, 4, 4.5, 5, 6, 7, 8, 10mm

601015 - TX KEY SET T-HANDLE 3 TIP, 10-PCS



ART. NO.	DESCRIPTION
4840210...55	T10, T15, T20, T25, T27, T30, T40, T45, T50, T55

4560201 - COTTER PIN DRIVER FOR BRAKE



- With extra long mandrel, specially for brake pins
- 175mm
- 4mm

4560202 - COTTER PIN DRIVER FOR BRAKE



- With extra long mandrel, specially for brake pins
- 175mm
- 6mm

803001 - ELECTRICAL CONNECTION CLIP REMOVER, 2-PCS



- Handy tools for removing electrical clips in confined or difficult areas
- Cushioned grip handles for non-slip operation
- Hook style and flat

ART. NO.	DESCRIPTION
803001-1	Clip remover hook
803001-2	Clip remover flat

600320 - SCRAPER SET, 3-PCS



ART. NO.	PCS	DESCRIPTION
47818	1	Sticker scraper
47819	1	Seal scraper
47820	1	Angle scraper

600436 - PRY BAR HEAVY DUTY SET, 4-PCS



ART. NO.	DESCRIPTION
-	Pry bar (straight) 890mm
-	Pry bar (45°) 890mm
-	Pry bar (75°) 635mm
-	Pry bar (90°) 635mm

600403 - PRY BAR SET, 4-PCS



ART. NO.	PCS	DESCRIPTION
48203210	1	Bent pry bar 8"
48203300	1	Bent forked pry bar 12"
48203460	1	Elbow bent pry bar 18"
48203610	1	Extended pry bar 24"

07

805003 - UNIVERSAL RATCHETING PRY BAR SET, 3-PCS



- Universal ratcheting pry bar allow easy access into areas which are difficult to reach
- Flexible head allows 8 different angles
- High leverage gear design provides maximum leverage while lifting and cutting back
- Fast and easy adjustable
- Thin feet
- For using/disassembling: gearbox, cylinderhead, waterpump and other parts
- Lengths: 250mm, 300mm, 380mm

ART. NO.	DESCRIPTION
805003-1	Universal ratcheting pry bar 10"
805003-2	Universal ratcheting pry bar 12"
805003-3	Universal ratcheting pry bar 15"

48212... - PRY BAR



ART. NO.	L(MM)	G	PCS/BAG
48212380	380	342	5
48212530	530	928	5
48212650	650	1122	5

803004 - PRY REMOVER SET, 11-PCS



- Extra slim and unique shape for delicate jobs such as removing small rivet or fine trims, bezels of dashboards, door panels, door locks, electronic seat controls, gear shifter, inner lining etc.
- Made of high quality impact-resistant nylon material
- Does not damage or scratch the surface

ART. NO.	PCS	DESCRIPTION
803004-1	1	Pry remover 1
803004-2	1	Pry remover 2
803004-3	1	Pry remover 3
803004-4	1	Pry remover 4
803004-5	1	Pry remover 5
803004-6	1	Pry remover 6
803004-7	1	Pry remover 7
803004-8	1	Pry remover 8
803004-9	1	Pry remover 9
803004-10	1	Pry remover 10
803004-11	1	Pry remover 11

803005 - PRY REMOVER SET, 5-PCS

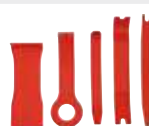

- Extra slim and unique shape for delicate jobs such as removing small rivet or fine trims, bezels of dashboards, door panels, door locks, electronic seat controls, gear shifter, inner lining... etc.
- Made of high quality impact-resistant nylon material
- Does not damage or scratch the surface

ART. NO.	PCS	DESCRIPTION
803005-1	1	Pry remover 1
803005-2	1	Pry remover 2
803005-3	1	Pry remover 3
803005-4	1	Pry remover 4
803005-5	1	Pry remover 5

Sonic special tools

821001 - PRY REMOVAL MASTER SET, 27-PCS



- Extra slim and unique shape for delicate jobs such as removing small rivet or fine trims, bezels of dashboards, door panels, door locks, electronic seat controls, gear shifter, inner lining,... etc.
- Made of high quality impact-resistant nylon material
- Does not damage or scratch the surface

600506 - WEDGE UTILITY SET, 5-PCS



- Utility wedge set suitable for removal of wide range of exterior body and interior trims
- Composite material reduces chances of marking or scratching paintwork body/trim
- Includes fork-ended trim stud removal tool

ART. NO.	PCS	DESCRIPTION
4821301	1	Wedge universal 190x30mm
4821302	1	Wedge felted surface 250x20mm
4821303	1	Wedge spiky 250x20mm
4821304	1	Wedge universal wide 190x60mm
4821305	1	Wedge special level 230x30mm

600318 - WEDGE UTILITY SET, 3-PCS



- Utility wedge set suitable for removal of wide range of exterior body and interior trims
- Composite material reduces chances of marking or scratching paintwork body/trim
- Includes fork-ended trim stud removal tool

ART. NO.	PCS	DESCRIPTION
4821301	1	Wedge universal 190x30mm
4821304	1	Wedge universal wide 190x60mm
4821305	1	Wedge special level 230x30mm

4821301 - WEDGE UNIVERSAL



ART. NO.	DESCRIPTION	L(MM)	W(MM)	N.W.(G)	PCS/BAG
4821301	Wedge universal	190	30	74	1

4821304 - WEDGE UNIVERSAL WIDE



ART. NO.	DESCRIPTION	L(MM)	W(MM)	N.W.(G)	PCS/BAG
4821304	Wedge universal wide	190	60	160	1

4821302 - WEDGE FELTED SURFACE



ART. NO.	DESCRIPTION	L(MM)	W(MM)	N.W.(G)	PCS/BAG
4821302	Wedge felted surface	250	20	90	1

4821305 - WEDGE SPECIAL LEVEL



ART. NO.	DESCRIPTION	L(MM)	W(MM)	N.W.(G)	PCS/BAG
4821305	Wedge special level	230	30	94	1

4821303 - WEDGE SPIKY



ART. NO.	DESCRIPTION	L(MM)	W(MM)	N.W.(G)	PCS/BAG
4821303	Wedge spiky	250	20	40	1

813001 - CRIMPING PLIERS



- Ratchet mechanism crimper stands for superior labour saving
- Quick insertion changing of jaw without any tool
- Professional AISI 4140 alloy steel crimping jaws
- Ergonomic comfort-grip handle

Features

- Crimping tool set with ratcheting function and adjustable jaws
- Includes 6 exchangeable crimping jaws
- Insulated terminal ends DIN 0.5-6mm²
- Non-insulated terminal ends DIN 1.5-10mm²
- Open barrel terminal ends DIN 0.5-4.0mm²
- Insulated cord-end terminal DIN 0.5-6mm² (for small sizes)
- Insulated cord-end terminal DIN 0.5-6mm² (for large sizes)
- Open barrel terminal & D-SUB,V3.5



Loose jaws for crimping plier

813002 - CRIMPING PLIERS



- Ratchet mechanism crimper stands for superior labour saving
- Quick insertion changing of jaw without any tool
- Professional AISI 4140 alloy steel crimping jaws
- Ergonomic comfort-grip handle

Features

- Crimping tool set with ratcheting function and adjustable jaws
- Includes 10 exchangeable crimping jaws
- Insulated terminal ends DIN 0.5-6mm²
- Non-insulated terminal ends DIN 1.5-10mm²
- Open barrel terminal ends DIN 0.5-4.0mm²
- Insulated cord-end terminal DIN 0.5-6mm² (for small sizes)
- Insulated cord-end terminal DIN 0.5-6mm² (for large sizes)
- Open barrel terminal & D-SUB,V3.5
- Cable connector (BNC)
- 4P4C Connector
- 6P6C Connector
- 8P8C Connector

ART. NO.	DESCRIPTION	ART. NO.	DESCRIPTION
81302	Jaw for insulated terminal Surface treatment - Procedure: precision and wax-lost casting - Finished with heat treatment [HRC 38°-45°] - Zinc phosphate surface treatment Material - AISI 4140 Suitable for - AWG 22-18/16-14/12-10 - DIN 0.5-1.0/1.5-2.5/4-6mm ²	81308	Jaw for cable connector (BNC) Surface treatment - Procedure: precision and wax-lost casting - Finished with heat treatment [HRC 38°-45°] - Zinc phosphate surface treatment Material - AISI 4140 Suitable for - 0.255"/0.213"/0.100"/0.068"/0.324" - 6.48/5.41/2.54/1.72/8.23mm - RG 58/59/62/6
81303	Jaw for non-insulated terminal Surface treatment - Procedure: precision and wax-lost casting - Finished with heat treatment [HRC 38°-45°] - Zinc phosphate surface treatment Material - AISI 4140 Suitable for - AWG 20-18/16-14/12-10/8 - DIN 1.5/2.5/6/10mm ² - JIS 1.25/2/5.5/8 mm ²	81309	Jaw for 4P4C connector Surface treatment - Procedure: precision and wax-lost casting - Finished with heat treatment [HRC 38°-45°] - Zinc phosphate surface treatment Material - AISI 4140 Suitable for - 4P4C/RJ22 plugs
81304	Jaw for open barrel terminal Surface treatment - Procedure: precision and wax-lost casting - Finished with heat treatment [HRC 38°-45°] - Zinc phosphate surface treatment Material - AISI 4140 Suitable for - AWG 20-18/16-14/12-10 - DIN 0.5-1.0/1.5-2.5/4-6mm ²	81310	Jaw for 6P6C connector Surface treatment - Procedure: precision and wax-lost casting - Finished with heat treatment [HRC 38°-45°] - Zinc phosphate surface treatment Material - AISI 4140 Suitable for - 6P2C/6P4C/RJ11 plugs - 6P6C/RJ12 plugs
81305	Jaw for cord-end terminal (small size) Surface treatment - Procedure: precision and wax-lost casting - Finished with heat treatment [HRC 38°-45°] - Zinc phosphate surface treatment Material - AISI 4140 Suitable for - AWG 22/20/18/16/14/12 - DIN 0.5/0.75/1.0/1.5/2.5/4.0mm ²	81311	Jaw for 8P8C connector Surface treatment - Procedure: precision and wax-lost casting - Finished with heat treatment [HRC 38°-45°] - Zinc phosphate surface treatment Material - AISI 4140 Suitable for - 8P8C/RJ45 plugs
81306	Jaw for cord-end terminal (large size) Surface treatment - Procedure: precision and wax-lost casting - Finished with heat treatment [HRC 38°-45°] - Zinc phosphate surface treatment Material - AISI 4140 Suitable for - AWG 10/8/6 - DIN 6/10/16mm ²	81315	Jaw for heat shrink butt connector Surface treatment - Procedure: precision and wax-lost casting - Finished with heat treatment [HRC 38°-45°] - Zinc phosphate surface treatment Material - AISI 4140 Suitable for - AWG 22-18/16-14-12-10/8(A1)
81307	Jaw for open barrel terminal Surface treatment - Procedure: precision and wax-lost casting - Finished with heat treatment [HRC 38°-45°] - Zinc phosphate surface treatment Material - AISI 4140 Suitable for - AWG 14/22/8-6 - DIN 2.5/0.5/8-10mm ²	81316	Jaw for 1.5 supperseal terminal Surface treatment - Procedure: precision and wax-lost casting - Finished with heat treatment [HRC 38°-45°] - Zinc phosphate surface treatment Material - AISI 4140 Suitable for - AWG 22-20/16 (H2)
		81317	Jaw for 1.5 supperseal terminal Surface treatment - Procedure: precision and wax-lost casting - Finished with heat treatment [HRC 38°-45°] - Zinc phosphate surface treatment Material - AISI 4140 Suitable for - AWG 18/17 (H2)

Sonic special tools

810002 - HOSE CLAMP PLIERS SET, 7-PCS



ART. NO.	DESCRIPTION
4472100	Hose clamp pliers. Allows extra reach, removal and locking of clamps into open position. Allows removal of plastic and/ or metal self-tightening hose clamps with diameters of 11/16"-2-1/2" (18mm-54mm). Precision clamp on end of flexible cable allows extended reach where other models can't reach. Pliers can be locked, freeing up your hands and making your job easier and faster. Cable and spring are portable items and must be replaced.
810002-1	Swivel jaw hose clamp pliers (+ slot)
810002-2	Swivel jaw hose clamp pliers. Swivel jaws are slotted for positive holding or large or small clamps at any angle. Ratchet action holds jaws closed in 5 different positions. Fits all automotive and appliance spring wire hose clamps. Allows fast and easy clamp removal. Pliers latch in position to securely hold hose clamp when expanded.
810002-3	Angled flat band hose clamp pliers. Designed to remove and install flat band hose clamps in hard-to-reach areas. Pliers feature angled jaws with 360° rotating tips to grip clamps at any angle. Locking latch securely holds clamp in position.
810002-4	Flat band hose clamp pliers. Removes and installs new style flat band hose clamps. Jaws rotate 360° to grip at any angle.
810002-5	Clic-R collar pliers. For releasing and re-fitting reusable hose clips. For type and clic-R.
810002-6	Hose remover pliers. Designed to allow easy removal of 5/32" to 1/2" vacuum and fuel hoses.

600308 - HOSE LINE CLAMP SET, 3-PCS



3-pcs hose line clamp set with special designed jaws to prevent internal hose linings from damage. Lightweight, easy to use and non conductive.

- Small clamp for 1/8" to 5/16" diameter
- Medium clamp for 1/2" to 3/4" diameter
- Large size clamp for 3/4" to 2-1/2" diameter
- Made of heat-resistant reinforced nylon
- Each clamp includes a locking mechanism

ART. NO.	DESCRIPTION
600308-1	Small clamp for 1/8" to 5/16" diameter
600308-2	Medium clamp for 1/2" to 3/4" diameter
600308-3	Large size clamp for 3/4" to 2-1/2" diameter

4822102 - HAMMER



ART. NO.	DESCRIPTION	L(MM)	G	PCS/BAG
4822102	Hammer	311	472	6

829007 - DOOR LOCK DISMANTLING TOOL - VOLKSWAGEN



Specially for the removal and installation of the covers of the door handles without cylinder lock. The lock is at a very inaccessible location. Suitable for Volkswagen Fox from 2005, Golf 6 from 2008, Passat B6 (3c) from 2005, Tiguan from 2008. Suitable for OEM number T10389.

4472100 - FLEXIBLE CABLE HOSE CLAMP REMOVING PLIERS



- Flexible clamp fastener
- Flexible cable to reach hard places
- Pliers latch in position to securely hold hose clamp when expanded
- Adjustable cable tension

812002 - DAMPER PULLEY PULLER HOLDER WRENCH SET 5-PCS



ART. NO.	DESCRIPTION
812002-1	Damper pulley puller holder wrench 13mm
812002-2	Damper pulley puller holder wrench 15mm
812002-3	Damper pulley puller holder wrench 16mm
812002-4	Damper pulley puller holder wrench 17mm
812002-5	Damper pulley puller holder wrench 19mm

805015 - PULLEY WRENCH SET; 12-19MM, E10-E18 15-PCS

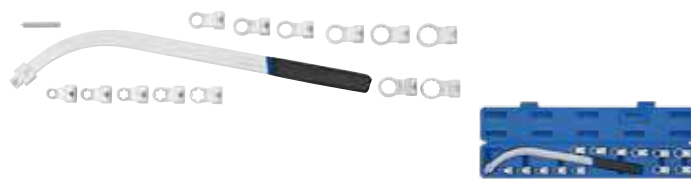

ART. NO.	PCS	DESCRIPTION
805015-1	1	Pulley wrench
805015-2	8	Pulley wrench head 12, 13, 14, 15, 16, 17, 18, 19mm
805015-10	5	Pulley wrench head E10, E12, E14, E16, E18

4831201 - CROSS RIM WRENCH



- Length 355mm
- Sizes 17, 19, 22mm
- Size 13/16"

829113 - BRAKE BLEEDER WRENCH SET 6PT 6-PCS



- Built in socket (6 point) and wrench
- Socket sizes 7, 8, 9, 10, 11, 12mm
- 1.2M silicon hose with check valve
- Ideal for bleeding brake and hydraulic clutch systems

These specialist brake bleeder wrenches are designed to simplify brake bleeding and the additional ease of access will in many cases let the operator bleed the brakes without removing the road wheels. Clean and lubricate the bleed valve then fit the wrench over it; the wrench's internal seal and built-in socket fits snugly over the valve. The bleed tube is then fitted onto the nipple that is built into the wrench. Thus the bleed tube can be turned and repositioned without any fear of dragging against the bleed tube, or separating the bleed tube from the valve. Six sizes of wrench are supplied in the set, to cover most popular applications: 7-8-9-10-11-12mm all color-coded for easy identification. Ideal for both brake and clutch hydraulic systems, the wrench set is supplied in a sturdy blow-mould case with internal foam to keep the wrenches and tube secure and tidy.

300401 - TORSION EXTENTION SET 1/2", 4-PCS



- 1 extension bar for using up to 90Nm
- 1 extension bar for using up to 100Nm
- 1 extension bar for using up to 110Nm
- 1 extension bar for using up to 120Nm

7150310 - GLOW PLUG JOINT 3/8", SOCKET, 10MM



For glow plugs (TDI + CDI) that are difficult to reach 10mm, 140mm!

805001 - GLOW PLUG SOCKET SET 3/8", 3-PCS



- These sockets have a universal joint for easy replacement and removal of popular sized glow plugs
- Manufactured from matt finished chrome vanadium
- Supplied in blow mould case for storage

SIZE

8, 10, 12mm x 72mm

Sonic special tools

300310 - TORQUE IMPACT SOCKET SET 1/2", 3-PCS



Impact-proof, fully encapsulated in plastic, extra thin walls, optimum force transmission, rims and bolts no longer become scratched, with groove and drill hole. Special length, specially suitable for drop centre rims. Any falsification of torque caused by putting extensions together is avoided.

ART. NO.	PCS	DESCRIPTION
3310517...21	3	Wheel socket 1/2" 150mm, 17, 19, 21mm

300302 - TORQUE IMPACT ADAPTOR SET 1/2", 3-PCS



- Socket 17, 19, 21mm
- Thin wall, plastic stop, length 105mm, maximum 200Nm

ART. NO.	PCS	DESCRIPTION
3310217...21	3	Wheel socket 1/2" 105mm, 17, 19, 21mm

300506 - WHEEL SOCKET SET 1/2", 5-PCS



⚠ Only use with torque wrenches

ART. NO.	PCS	DESCRIPTION
3310115...22	5	Wheel socket 1/2", 15, 17, 19, 21, 22mm

300507 - POWER IMPACT SOCKET SET 1/2", 5-PCS



⚠ Only use with torque wrenches

ART. NO.	PCS	DESCRIPTION
3310715...22	5	Impact wheel socket 1/2", 15, 17, 19, 21, 22

300301 - WHEEL SOCKET SET 1/2", 3-PCS



⚠ Only use with torque wrenches

ART. NO.	PCS	DESCRIPTION
3310117...21	3	Wheel socket 1/2", 17, 19, 21mm

300311 - WHEEL SOCKET SET 1/2", 3-PCS



ART. NO.	PCS	DESCRIPTION
3310717...21	3	Wheel socket 1/2", 6 pt. 17, 19, 21mm

- This thin-walled impact socket will last 7 times longer than the conventional wheel sockets
- Specially for the wheel assembly and/or dismantling
- Internal square drive to DIN 3121 / ISO 1174
- Long execution
- For machinery usage
- Plastic sleeves for the damage-free work on aluminium rims
- Plastic sleeve protects the surface at the wheel screws/nuts
- Plastic sleeves interchangeable
- Color coded identifies the socket size
- Phosphate finish
- Chrome Molybdenum [CR-MO]
- In plastic case

300312 - WHEEL SOCKET SET 1/2" 6PT. WITH RING 150MML, 3-PCS



ART. NO.	PCS	DESCRIPTION
3310817...21	3	Wheel socket 1/2", 6pt. 105mm, 17, 19, 21mm with ring

- This thin-walled impact socket will last 7 times longer than the conventional wheel sockets
- Specially for the wheel assembly and/or dismantling
- Internal square drive to DIN 3121 / ISO 1174
- Length 150mm
- For machinery usage
- Plastic sleeves for the damage-free work on aluminium rims
- Plastic sleeve protects the surface at the wheel screws/nuts
- Plastic sleeves interchangeable
- Color coded identifies the socket size
- Phosphate finish
- Chrome Molybdenum [CR-MO]
- In plastic case

300304 - TORQUE IMPACT ADAPTOR SET 1/2", 3-PCS



- 3/8", 1/2", 3/4"
- Up to 100Nm
- Length 100mm(l)
- Set to loosen the lug nuts with full torque delivery of impact wrench
- Patented design for fastened the lug nuts quickly and accurately to reach presetting torque strength. The torque socket will run free automatically when set torque is reached
- Check the torque strength by torque wrench, according to the maintenance manual of different vehicles. To ensure the nuts fastened securely with correct torque strength

⚠ **WARNING** This product is designed for safety. Because the tightening torque is always lower than the safety value. (The preset torque will decrease gradually and finally stable at about 25-35 Nm.)
Must use torque wrench for final tightening.

ART. NO.	DESCRIPTION
300304-1	Torque limited impact adaptor 3/8"
300304-2	Torque limited impact adaptor 1/2"
300304-3	Torque limited impact adaptor 3/4"

300303 - TORQUE IMPACT SOCKET SET 1/2", 3-PCS

- Sockets 17, 19, 21mm
- Up to 100Nm
- Length 100mm(l)
- Set to loosen the lug nuts with full torque delivery of impact wrench
- Patented design for fastened the lug nuts quickly and accurately to reach presetting torque strength. The torque socket will run free automatically when set torque is reached
- Check the torque strength by torque wrench, according to the maintenance manual of different vehicles. To ensure the nuts fastened securely with correct torque strength

⚠ WARNING This product is designed for safety. Because the tightening torque is always lower than the safety value. (The preset torque will decrease gradually and finally stable at about 25-35 Nm.)
Must use Torque Wrench for final tightening.

300504 - SPIRAL SOCKET SET 1/2", 5-PCS

- Removes rounded/damaged nuts and bolts
- Manufactured from Chrome Molybdenum (CR-MO) for strength

ART. NO.	DESCRIPTION
300504-1	Spiral socket 1/2", 17mm
300504-2	Spiral socket 1/2", 19mm
300504-3	Spiral socket 1/2", 21mm
300504-4	Spiral socket 1/2", 23mm
300504-5	Spiral socket 1/2", 27mm
300504-6	Bar 50mml

818026 - SPIRAL SOCKET SET 1/4" & 1/2", 15-PCS

- Removes rounded/damaged nuts and bolts
- Manufactured from Chrome Molybdenum (CR-MO) for strength

ART. NO.	PCS	DESCRIPTION
818026-1	1	Pin bar (small)
818026-2	1	Pin bar (large)
818026-6	1	Twist socket 1/4" 6mm
818026-8	1	Twist socket 1/4" 8mm
818026-10	1	Twist socket 1/4" 10mm
818026-11	1	Twist socket 1/4" 11mm
818026-12	1	Twist socket 1/4" 12mm
818026-13	1	Twist socket 1/2" 13mm
818026-14	1	Twist socket 1/2" 14mm
818026-15	1	Twist socket 1/2" 15mm
818026-17	1	Twist socket 1/2" 17mm
818026-19	1	Twist socket 1/2" 19mm
818026-21	1	Twist socket 1/2" 21mm

300901 - SPIRAL SOCKET SET 3/8", 10-PCS

- Removes rounded/damaged nuts and bolts
- Manufactured from Chrome Molybdenum (CR-MO) for strength

ART. NO.	DESCRIPTION
300901-1...9	Spiral socket 3/8", 10, 11, 12, 13, 14, 15, 16, 17, 19mm
300901-10	Bar 50mml

820014 - METRIC TAP AND DIE SET, 32-PCS

PCS	DESCRIPTION
21	Taps (3pcs per size) M3xP0.5, M4xP0.7, M5xP0.8, M6xP1.0, M8xP1.25, M10xP1.5, M12xP1.75
7	Dies size M3xP0.5, M4xP0.7, M5xP0.8, M6xP1.0, M8xP1.25, M10xP1.5, M12xP1.75
1	Tap wrench M3 - M12
1	Die handle Ø25mm (O/D)
1	Thread pitch gauge
1	Screwdriver

820015 - METRIC TAP AND DIE SET, 40-PCS

PCS	DESCRIPTION
21	Taps size M3xP0.5, M3xP0.6, M4xP0.7, M4xP0.75, M5xP0.8, M5xP0.9, M6xP0.75, M6xP1.0, M7xP0.75, M7xP1.0, M8xP1.0, M8xP1.25, M10xP1.25, M10xP1.5, M12xP1.25, M12xP1.5, 1/8"-17 NPT
17	Dies size M3xP0.5, M3xP0.6, M4xP0.7, M4xP0.75, M5xP0.8, M5xP0.9, M6xP0.75, M6xP1.0, M7xP0.75, M7xP1.0, M8xP1.0, M8xP1.25, M10xP1.25, M10xP1.5, M12xP1.25, M12xP1.5, 1/8"-17 NPT
1	Adjustable tap wrench M3 - M12
1	T-Handle tap wrench M3 - M6
1	Die handle Ø25mm (O/D)
1	Thread pitch gauge
1	Screwdriver

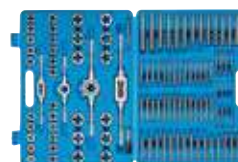
820016 - METRIC TAP AND DIE SET, 110-PCS

PCS	DESCRIPTION
35	Taper taps
35	Plug taps
35	Dies size M2xP0.4, M3xP0.5, M4xP0.7, M5xP0.8, M6xP0.75, M6xP1.0, M7xP0.75, M7xP1.0, M8xP0.75, M8xP1.0, M8xP1.25, M9xP0.75, M9xP1.0, M9xP1.25, M10xP0.75, M10xP1.0, M10xP1.25, M10xP1.5, M11xP0.75, M11xP1.0, M11xP1.25, M11xP1.5, M12xP0.75, M12xP1.0, M12xP1.25, M12xP1.5, M12xP1.75, M14xP1.0, M14xP1.25, M14xP1.5, M14xP2.0, M16xP1.0, M16xP1.5, M16xP2.0, M18xP1.5
2	Adjustable tap wrench M3 - M12, M6 - M20
1	T-Handle tap wrench M3 - M6
2	Die handle Ø25mm, Ø38mm (O/D)

Sonic special tools

829006 - WHEEL NUT KEY SET - AUDI, 22-PCS



22 pcs. Audi set complete including 21mm adapter with 1/2" square drive. This kit is designed for the removal of locking bolts when the customer has forgotten to provide the adapter by the car. This is happening very often when the vehicle is brought to maintenance and/or repair. Suitable for OEM T40073.

829004 - WHEEL NUT LOCK SET - VAG, 23-PCS



23-pcs Volkswagen set, including 17mm wheel socket with 1/2" connection. This kit is designed for the removal of locking bolts when the customer has forgotten to provide the adapter by car. This is happening very often when the vehicle is brought to maintenance and/or repair. Sizes: 6, 7, 8, 9, 10, 11, 12, 13, 14, 15, 16, 17 and 0/10, 1/11, 2/13, 3/14, 4/15, 5/16, 6/17, 7/19, 8/20, 9/21. For Volks-wagen from 2010: Beetle, Golf, Jetta, Passat, Polo, Scirocco, Sharan, Touran and Tiguan. Suitable for OEM numbers T10101, T40004.

801206 - BOLT TWISTER SOCKET SET 3/8", 6-PCS



Extracts the jammed or fractured screw head caused by over-powered, bad quality or wearing-out

ART. NO.	PCS	DESCRIPTION
801206-1	1	Bolt twister socket 3/8", 2mm
801206-2	1	Bolt twister socket 3/8", 3mm
801206-3	1	Bolt twister socket 3/8", 4mm
801206-4	1	Bolt twister socket 3/8", 6mm
801206-5	1	Bolt twister socket 3/8", 8mm
801206-6	1	Bolt twister socket 3/8", 10mm

801305 - BOLT TWISTER SOCKET SET 1/2", 5-PCS



Extracts the jammed or fractured screw head caused by over-powered, bad quality or wearing-out

ART. NO.	PCS	DESCRIPTION
801305-1	1	Bolt twister socket 1/2", 8mm
801305-2	1	Bolt twister socket 1/2", 10mm
801305-3	1	Bolt twister socket 1/2", 12mm
801305-4	1	Bolt twister socket 1/2", 14mm
801305-5	1	Bolt twister socket 1/2", 16mm
801206-6	1	Bolt twister socket 3/8", 10mm

829111 - WHEEL HANGER SET, 5-PCS



- Wheels becoming larger and more unwieldy, these wheel hanger pins simplify the wheel installation process by holding the rim centred on the hub as you hand screw in the wheel bolts
- Ideal when fitting wheel spacers: aligns the bolt holes, spacer and wheel together
- Particularly useful when replacing the brake discs - the wheel hanger pin ensures that the holes in the new disc are perfectly aligned with the holes in the wheel hub. Then the disc securing screws can be fitted with the wheel hanger pin in place
- The four most common thread and pitch sizes are included plus wheel stud version for hubs with wheel studs

DESCRIPTION

- M12x1.5
- M14x1.25
- M14x1.5
- M16x1.5
- M12x1.25 (wheel stud version)

100301 - ADAPTORS FOR DRILLS, 1/4"DR, 3-PCS



ART. NO.	PCS	DESCRIPTION
100301-1	1	Adaptor for drills and cordless screwdrivers 1/4"
100301-2	1	Adaptor for drills and cordless screwdrivers 3/8"
100301-3	1	Adaptor for drills and cordless screwdrivers 1/2"

802214 - DRAIN PLUG KEY SET 3/8", 14-PCS



ART. NO.	PCS	DESCRIPTION
802214-1	1	Hex 8mm
802214-2	1	Hex 9mm
802214-3	1	Hex 10mm
802214-4	1	Hex 12mm
802214-5	1	Hex 14mm
802214-6	1	Hex 17mm
802214-7	1	Square 7mm
802214-8	1	Square 8mm
802214-9	1	Square 11mm
802214-10	1	Square 13mm
802214-11	1	Square 3/8"
802214-12	1	Square 5/16"
802214-13	1	10mm square (female)
802214-14	1	Triangular

302001 - OIL DRAIN SET 1/2", 20-PCS



Metal band filter wrench 60-120 diameter

SIZE	VEHICLE
Oil filter wrench	-
3/8" extension 250mm	-
Adaptor for extension	-
7mm square	-
8mm square	Citroën, Peugeot, Renault, Talbot, Volvo
10mm square	-
11mm square	Ford
12mm square	-
13mm square	Nissan, Subaru
14mm square	-
5/16" square	-
3/8" square	Honda, Mazda, Renault, Saab, Volvo
10mm	-
10mm triangular	Renault
8mm hex	BMW, Ford, GM
9mm hex	Gm
10mm hex	Ford
12mm hex	Fiat, Lancia, Peugeot
14mm hex	Lancia, Mercedes
17mm hex	Audi, VW, BMW, Austin

07

829008 - SUMP PLUG REMOVAL TOOL - VAG



For plastic drain plugs with OEM number 06L-103-801 VAG 4-cylinder 2.0 TDI engine of the third generation. The drain plug has a special connection, for which a special bit is needed. This 1/4" bit has got a hex drive as per DIN 3126 / ISO 1173 C 6.3. Applicable for: Audi, Seat Leon, Volkswagen Golf 7 from 2013. Suitable for OEM Nummer T10549. Pay attention: when inserting the screw again always use a new O-ring.

829009 - FUEL SENDER/PUMP CLAMPING RING REMOVAL TOOL VAG



For the assembly and disassembly of the tank float with most Volkswagen and Audi models. Inner diameter 120mm. With 1/2" connection. For models from 2000 at Audi A3 A4 A6 A7 A8 Q3 Q5 Q7 R8 TT and Volkswagen Beetle, Caddy, Eos, Golf, Golf Cabrio, Golf Plus, Jetta, Passat, Passat CC, Phaeton, Polo, Sharan, Scirocco, Tiguan, Touareg, Touran, transporter including utility vehicles. Suitable for OEM number T10202 [VAG 3087].

Sonic special tools

806001 - ALTERNATOR, 13-PCS



Removes and installs press-on-type belt drive accessory pulleys. Works with hand tools or an impact gun. Interchangeable components to work on VW, Audi, Seat, Mercedes, Renault, BMW, Fiat, etc....

ART. NO.	DESCRIPTION
806001-1	Combined socket for alternator T50x113mml
806001-2	Combined socket for alternator M10x113mml
806001-3	Teeth socket hex 15mm x 33 teeth
806001-4	Teeth socket hex 22mm x 33 teeth
806001-5	Hex driver 22mm
806001-6	Round driver 35mm
806001-7	Bitholder 1/2" x 10mm
806001-8	Bit 10mm hex x 75mml; T40
806001-9	Bit 10mm hex x 75mml; T50
806001-10	Bit 10mm hex x 75mml; M8
806001-11	Bit 10mm hex x 75mml; M10
806001-12	Bit 10mm hex x 75mml; hex 8mm
806001-13	Bit 10mm hex x 75mml; hex 10mm

817006 - ALTERNATOR BIT SOCKET 1/2", T50X110L



For mounting freewheel belt pulley. The belt pulley is held by 33 teeth-insert.

817007 - ALTERNATOR BIT SOCKET, 1/2", M10X110L



For mounting freewheel belt pulley. The belt pulley is held by 33 teeth-insert.

83805517 - BIT SOCKET XZN 1/2", M17 55MML



- M17
- 55mml
- For cylinder head screws Mercedes-Benz M400, M420, M500 engines

818007 - ALTERNATOR PULLEY SET, 18-PCS



A comprehensive range of combination sockets required on the free wheel pulley when removing or replacing the alternator. The set includes tools for Bosch, Marelli and Valeo alternators and is now complete with the new tools required for the latest Renault and Fiat alternators.

ART. NO.	DESCRIPTION
818007-1	Combined socket for alternator T50x113mml
818007-2	Combined socket for alternator M10x113mml
818007-3	Teeth socket hex 15mm x 33 teeth
818007-4	Teeth socket hex 22mm x 33 teeth
818007-5	Hex driver 22mm
818007-6	Round driver 35mm
818007-7	Bitholder 1/2" x 10mm
818007-8	Bit 10mm hex x 75mml; T40
818007-9	Bit 10mm hex x 75mml; T50
818007-10	Bit 10mm hex x 75mml; M8
818007-11	Bit 10mm hex x 75mml; M10
818007-12	Bit 10mm hex x 75mml; hex 8mm
818007-13	Bit 10mm hex x 75mml; hex 10mm
818007-14	Bit socket 110mml; M10
818007-15	Hex driver 22x28mm
818007-16	Bit 12mm spline 64mml; M10
818007-17	Hex driver 19 x 28mm
818007-18	Bit socket 3/8", M10 x 90mml

822001 - ADBLUE REFRACTOMETER



This optical refractometer is designed for checking the concentration of antifreeze and battery acid but also Adblue.
 - Designed for checking the concentration of Adblue.
 - Urea additive in the exhaust flow which reduces NOx-emissions.

DESCRIPTION

Style	Battery / coolants / adblue
Range	-60°F - 32°F / 1.15 - 1.30sg
Resolution	10°F; 0.01sg
Adblue	30% - 35%
Ethylene Glycol	-50°C-0°C
Propylene Glycol	-40°C-0°C
Cleaning Fluids	-40°C-0°C
Battery Fluids	1.100 - 1.400sg
Resolution Factor	0.5%, 5°C, 5°C, 5°C, 0.01sg
Size	27 x 40 x 160mm
Weight	176g

822002 - REFRACTOMETER



This optical refractometer is designed for checking the concentration of antifreeze and battery acid.

DESCRIPTION

Style	Battery / coolants
Range	-60°F - 32°F / 1.15 - 1.30sg
Resolution	10°F; 0.01sg
Adblue	30% - 35%
Ethylene Glycol	70°C-0°C (-90°F-32°F)
Propylene Glycol	-60°C-0°C (-70°F-32°F)
Battery Fluids	1.100 - 1.400sg
Size	27 x 40 x 160mm
Weight	176g

828001 - TYRE REPAIR TOOL SET, 45-PCS

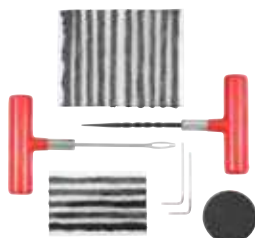

ART. NO.	DESCRIPTION
828001-1	Tyre repair plugs
828001-2	Tyre repair lubricant
828001-3	T-handle insert tool
828001-4	T-handle spiral probe
828001-5	3mm hex wrench

810004 - TYRE VALVE DRIVER, 2-PCS



With torque limitation. This ensures a reliable fit and prevents sensitive valves being over wound.
 - Inserting tool with 0.25Nm for rubber valves
 - Inserting tool with 0.45Nm for metal valves

47826 - TYRE VALVE DRIVER 0.25NM



47827 - TYRE VALVE DRIVER 0.45NM



812003 - TYRE VALVE STEM FITTING TOOL



For fitting new valves in the rim valve hole on tubeless tyres.
 310mm

810003 - AIR BAG REMOVAL TOOL SET, 12-PCS



APPLICATION

A 12-pcs tool kit for removing air bags on Volkswagen, Audi, Seat, Skoda, BMW and Mercedes

VW Passat B5, Polo, Lupo, Audi A4 and A6, Skoda Suberb

VW Golf 4, New Beetle, Seat, Skoda Fabia, Octavia 1999

VW Golf 4 (bj. 1998-2004) VW Passat 1997, VW Bora 1999

VW Modell, Passat 2000

T30 for Sudi, Opel, Renault, VW

T30H for Audi, BMW, Mercedes, Opel

T25 for BMW

T25H for BMW

5mm hex, for Audi

Sonic special tools

47023 - BRAKE FLUID TESTER



This tester can be used as a digital brake fluid tester suitable for determining brake fluid quality. Developed for professional use in automotive repair shops and in servicing.

ART. NO.	DESCRIPTION	L (MM)	N.W.(G)	PCS/BAG
47023	Brake fluid tester	50	52	1

4830801 - THREE-LEG OIL FILTER WRENCH



- Gear-driven and heat-treated legs will handle high torque applications
- Removes filters from 2-1/2" to 4" diameter (63-102mm)
- Use 1/2" or 3/8" square tool 13/16" (21mm) wrench

4830802 - THREE-LEG OIL FILTER WRENCH (65-120MM)



- Removes oil filters from 2 1/2" - 4 3/4" diameter (63,5-12,6mm)
- Use 1/2" or 3/8" square tool or 21mm (13/16") wrench

4831302 - OIL FILTER WRENCH CLAW, AUTO ADJUST



812007 - OIL FILTER CAP 14 PT. 74MM



ART. NO.	L(MM)	G	PCS/BAG
812007	85	166	1

812008 - HINGED CHAIN WRENCH FOR OIL FILTERS



811003 - OIL FILTER CARTRIDGE INSERT



ART. NO.	SIZE	L(MM)	G	PCS/BAG
811003-27	27	38	106	1
811003-32	32	44	144	1
811003-36	36	50	172	1

803003 - OIL FILTER CUP SET, 15-PCS



- Made of gauge construction
- Able to withstand up to 85ft. lbs of torque
- Cup-type design grips like a socket minimizing the possibility of cruse hung filters
- Fits adaptor 1/2"(F) or 3/8"(M) tool
- Coated with electro-black oxide finish for protection against rust
- Suitable for canister filters

ART. NO.	FLUTE SIZE	APPLICATION
803003-2	65mm x 14	Nissan, Fiat, Hasting, GM/AC, Wix, Napa, Purolator, Daihatsu, Toyota
803003-3	68mm x 14	Hastings, Mazda, Ford, Subaru
803003-4	73mm x 14	Toyota, Lexus
803003-5	74-76mm x 15	Ford, Opel, VW, Audi, Mercedes, Fram, AC
803003-7	76mm x 14	Audi, Opel, Champion, Purolator, Mopar, VW, Porsche, Mercedes, BMW
803003-10	80mm x 15	Opel, Hastings, Fram, Purolator, Nissan, Honda, Motorcraft, Isuzu, Mazda, Subaru
803003-12	93mm x 15	Mazda, Volvo, Mitsubishi, Honda, Casite, Champ, Champion, GM, Fram, Hastings, Purolator, Wix, Nissan, VW, Porsche, Renault
803003-13	93mm x 36	Ford, Motorcraft
803003-1	65-67mm x 14	Daihatsu, Toyota
803003-9	80-82mm x 15	Wix, Mazda, Subaru, Toyota, Honda, Acura, Nissan
803003-11	90mm x 15	Honda, Mitsubishi, Mopar, Isuzu
803003-6	75-77mm x 15	VW, Audi, Mercedes, Opel, Castite, GM/AC, Hastings, Wix, Ford, Isuzu
803003-8	76mm x 30	Motorcraft
803003-14	100mm x 15	Fram, Motorcraft, Wix, Isuzu, Mitsubishi
803003-15	9.5mm	Adaptor 1/2"(F) of 3/8"(M) tool

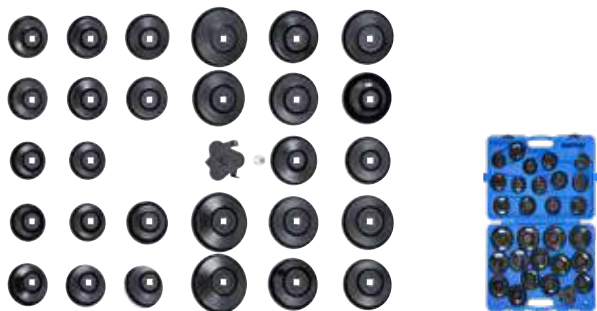
811002 - OIL FILTER CAP SET, 30-PCS

- Made of gauge construction
- Able to withstand up to 85ft. lbs of torque
- Cup-type design grips like a socket minimizing the possibility of cruse hung filters
- Fits adaptor 1/2" (F) or 3/8" (M) drive tool
- Coated with electro-black oxide finish for protection against rust
- Suitable for canister filters

ART. NO.	FLUTE SIZE	APPLICATION
811002-1	66mm x 6	Fiat, Renault
811002-2	65mm x 14	Daihatsu, Toyota, Nissan, Fiat
811002-3	65-67mm x 14	Daihatsu, Toyota
811002-4	68mm x 14	Mazda, Ford, Subaru
811002-5	73mm x 14	Toyota, Lexus
811002-6	74mm x 15	Audi, Rover, Chrysler
811002-7	74-76mm x 15	Ford, Opel, VW, Audi, Mercedes
811002-8	75-77mm x 15	VW, Audi, Isuzu, Mercedes
811002-9	76mm x 12	Fiat, Mercedes, Renault
811002-10	76mm x 14	VW, Porsche, Mercedes, BMW, Audi, Opel
811002-11	76mm x 30	Ford
811002-12	76mm x 8	Fiat, Lancia
811002-13	78mm x 15	Nissan, Ford, Toyota
811002-14	80mm x 15	Nissan, Honda, Opel, Mazda
811002-15	80-82mm x 15	Subaru, Toyota, Honda, Nissan
811002-16	86mm x 16	Volvo
811002-17	86mm x 18	VW, Audi, Peugeot, Citroën
811002-18	90mm x 15	Honda, Mitsubishi, Isuzu
811002-19	92mm x 10	Fiat
811002-20	93mm x 15	Mazda, Volvo, Mitsubishi, Nissan, Honda
811002-21	93mm x 36	Ford
811002-22	93mm x 45	VW, Audi
811002-23	95mm x 15	Toyota, Alfa, Ford
811002-24	96mm x 18	Audi, VW, Renault
811002-25	100mm x 15	Isuzu, Mitsubishi
811002-26	106mm x 15	Fiat
811002-27	108mm x 15	Volvo
811002-28	108mm x 18	Renault
811002-29	Adaptor	Adaptor 1/2" (F) x 3/8" (M)

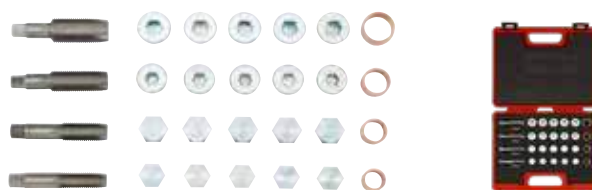
801003 - OIL DRAIN REPAIR KIT

Solid and fast solution for the repair of defect threads at the oil pan. By drilling out and using a larger drain plug a solid repair is granted. Universally usable for Audi, BMW, Citroën, Daimler, Ford, Fiat, Honda, Mazda, Mitsubishi, Nissan, Opel, Peugeot, Porsche, Renault, Saab, Seat, Skoda, Toyota, Volvo, VW.

ART. NO.	DESCRIPTION
801003-1	Thread cutter m13x1,5
801003-2	Thread cutter m15x1,5
801003-3	Thread cutter m17x1,5
801003-4	Thread cutter m20x1,5
801003-5	Oil drain plugs m13x1,5
801003-6	Oil drain plugs m15x1,5
801003-7	Oil drain plugs m17x1,5
801003-8	Oil drain plugs m20x1,5
801003-9	Aluminium sealing ring 17
801003-10	Aluminium sealing ring 19
801003-11	Aluminium sealing ring 8
801003-12	Aluminium sealing ring 10

07
829001 - BRAKE ADAPTOR SET - ADJUSTABLE

This set is an essential supplement to the existing brake caliper sets, which are already available in most workplaces. The set is suitable for the most common brake pistons with a 3/8" drive. The set consists of 3 adaptors.

Adaptor 1 is an adaptor with two pins steplessly adjustable from 15 to 35mm. Can stand up to 50Nm. Adaptor 2 with three adjustable legs to adjust the electronic handbrake. Use it usually in combination with the necessary electronic parking brake tool.

Adaptor 3 is an adaptor of 3/8" square drive for connection to the resetting adapter.

ART. NO.	DESCRIPTION
829001-1	Adaptor #1 2 pin adaptor
829001-2	Adaptor #2 3 pin adaptor
829001-3	Adaptor #3

810006 - BRAKE CALIPER PISTON REWIND TOOL KIT

This tool set is designed for Tesla rear brake caliper piston rewind. Supplied with left- and right-handed winders enabling the return of the brake piston into the caliper delivering clearance for the new brake pads. 1 piece 3/8" rotating caliper (right & left side threaded allow) 2 pieces adaptors for brake assemblage

Sonic special tools

801016 - PNEUMATIC BRAKE CALIPER SERVICE SET, 16-PCS

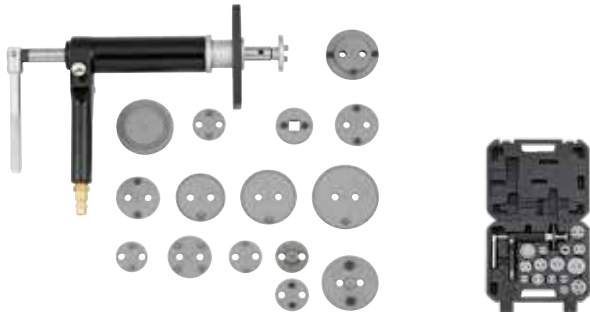

Pneumatic rewind tool for left and right hand threaded pistons and 15 adaptors

ART. NO.	DESCRIPTION	SUITABLE FOR
801016-1	0 Disc	Gm most 2-1/2" diameter pistons
801016-2	2 Disc	Citroën XM, Xantia, Honda
801016-3	3 Disc	Audi (F), Fiat, Alfa Romeo(F), Ford Fiesta(F), Isuzu(F), Honda Concesto(F), Jaguar XJ6, XJ40(F/R), BMW 318is, 320i, 325TD, 518i, 525i, 850ci, M5(F), Mercedes Benz 190, 200, 300, 420, 560 series (F), Mitsubishi Colt(F), Nissan Micra, Stanza, Sunny(F), Rover Austin, Metro 200 & 400 series, Maesta, Montego, Toyota camry(F), Volvo(F), VW passat, Golf gti(F)
801016-4	4 Disc	Ford Australia, NZ telstar, Mazda(R), Saab 9000(R), Lumina, Toyota, Fiat, Alfa Romeo 164 2.0(R), Honda prelude, CRS 16i, GM Saturn(R), Grand Prix
801016-5	5 Disc	3/8" adaptor
801016-6	6 Disc	Nissan Primera, VW Golf IV
801016-7	7 Disc	Audi 80, 90, V8-100, Coupe E (R), Rover 800 ABS, Subaru L-Z(R), Ford Sierra ABS, Granada, Scorpio ABS 85(R), Nissan Bluebird 1.8 turbo, Silvia turbo, primera 2.0i LS/GS/GSX(R), Peugeot 405 1.9Gi, Gri, Sri, Gtxi, MI 16, 605 2.0Sri (R), Toyota Celica, Corolla GT, MR2, VW Golf gti, Jetta synchro, jetta gti 16v, Passat CL, GL, GT, GT 16v, Corrado 16V, Scirroco GTX 16V(R), Citroën, Alfa Romeo, Fiat, Honda, Jaguar, Renault, Saab, Seat, Lancia
801016-8	8 Disc	GM most 1-7/8" diameter pistons
801016-9	9 Disc	GM most 2-1/8" diameter pistons
801016-10	A(Z) Disc	Renault R21, Laguna
801016-11	E Disc	Nissan Maxima, Ford
801016-12	F(G) Disc	Opel(R)
801016-13	M Disc	Ford, Mini, Mazda 3
801016-14	N Disc	Saab, Honda, Alfa Romeo, Audi, VW, Lancia
801016-15	K Disc	Citroën

801018 - BRAKE CALIPER SERVICE SET, 18-PCS

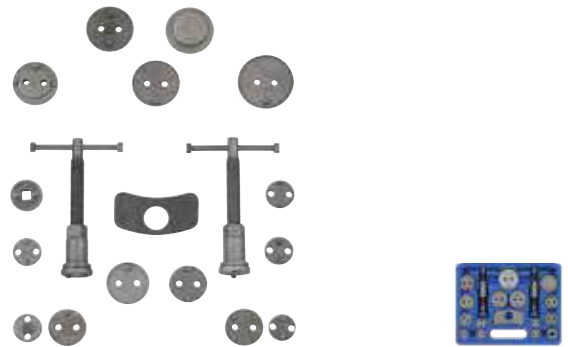

ART. NO.	DESCRIPTION	SUITABLE FOR
805011	Brake piston right spindle	Right hand helix bolt
805010	Brake piston left spindle	Left hand helix bolt
801018-2	2 Disc	Citroën XM, Xantia(F/R)
801018-3	3 Disc	Audi (F), Fiat, Alfa Romeo(F), Ford Fiesta(F), Isuzu(F), Honda Concesto(F), Jaguar XJ6, XJ40(F/R), BMW 318is, 320i, 325TD, 518i, 525i, 850ci, M5(F), Mercedes Benz 190, 200, 300, 420, 560 series (F), Mitsubishi Colt(F), Nissan Micra, Stanza, Sunny(F), Rover Austin, Metro 200 & 400 series, Maesta, Montego, Toyota camry(F), Volvo(F), VW passat, Golf gti(F)
801018-4	4 Disc	Ford Australia, NZ telstar, Mazda(R), Saab 9000(R), Fiat, Alfa Romeo 164 2.0(R), Honda prelude, CRS 16i, GM Saturn(R), Grand Prix, Lumina
801018-5	5 Disc	3/8" adaptor
801018-6	6 Disc	Nissan Primera, VW Golf IV
801018-7	7 Disc	Audi 80, 90, V8-100, Coupe E (R), Rover 800 ABS, Subaru L-Z(R), Ford Sierra ABS, Granada, Scorpio ABS 85(R), Nissan Bluebird 1.8 turbo, Silvia turbo, primera 2.0i LS/GS/GSX(R), Peugeot 405 1.9Gi, Gri, Sri, Gtxi, MI 16, 605 2.0Sri (R), Toyota Celica, Corolla GT, MR2(R), VW Golf gti, Jetta synchro, jetta gti 16v, Passat CL, GL, GT, GT 16v, Corrado 16V, Scirroca GTX 16V(R)
801018-8	8 Disc	GM most 1-7/8" diameter pistons
801018-9	9 Disc	GM most 2-1/8" diameter pistons (Cadi Seville/ Eldorado 80-85)
801018-1	0 Disc	GM most 2-1/2" diameter pistons (Seville/Eldorado 79)
801018-10	A Disc	Renault R21, Laguna (Rear Disk)
801018-11	M Disc	Ford, Mini, Mazda 3
801018-12	N Disc	Saab, Honda
801018-13	F Disc	Opel (Rear Disk)
801018-14	K Disc	Citroën
801018-15	E Disc	Nissan Maxima

829005 - BRAKE PIPE CORROSION TOOL



This scraper is very suitable for the removal of corrosion on the brake lines. This is important for MOT, maintenance and service. With 2-component handle.

80501... - BRAKE PISTON SPINDLE



For set 801018, 805002 and 809007

ART. NO.	DESCRIPTION
805010	Brake piston left spindle
805011	Brake piston right spindle

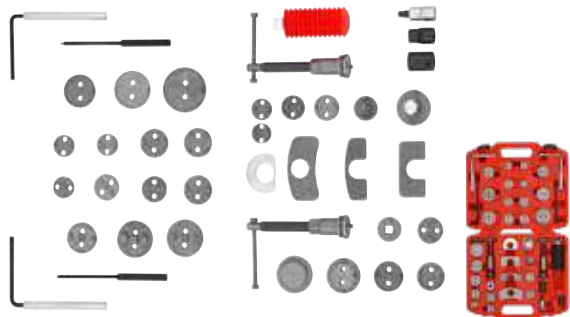
809007 - BRAKE CALIPER SET, 40-PCS

Rewind tool for left and right hand threaded pistons and 12 adaptors

ART. NO.	DESCRIPTION	SUITABLE FOR
809007-2	2 Disc	Citroën BX(83), 16V(88-), Honda Prelude 2.0i, 2.3
809007-3	3 Disc	Audi A3(A4, A6, A8 push-back pistons), BMW-most models(push-back pistons), Citroën XM, XM Turbo CT20, Xantia 1.8i-1.90 & TD-2 QI-2Q 16S(93-94), Activa, Citroën C5 rear callipers push-back pistons, Ford (USA) Mercury, Monarch, Thunderbird, Honda-most models(push-back pistons), Jaguar-most models (push-back pistons), Mitsubishi most models (push-back pistons), Nissan-most models (push-back pistons), Peugeot 406, 806, Rover-most models(push-back pistons), Toyota-most models(push-back pistons), Volkswagen-most models(push-back pistons), Volvo-most models
809007-4	4 Disc	Alfa Romeo 164 2.0 I, Fiat Uno Turbo i- Barchetta, Ford Escort 2000RS 16V, Mondeo V6 24V, Honda Civic Vti-CRX-Accord Concerto S 1.6, Rover 220 C Turbo (95), Saab 99L, 900 Turbo(74-81) 900(81-87)
809007-5	6 Disc	Jaguar S Type
809007-6	7 Disc	Jaguar S series(99-), Opel Astra G, Corsa C, Zafira (with Lucas TRW rear calipers 02)
809007-7	8 Disc	GM Motors
809007-8	9 Disc	GM Motors
809007-1	0 Disc	GM Motors Disc-Citroën ZX 2.0i 16V, Citroën most models (push-back pistons), Citroën XM, XM Turbo CT 2.0, Xantia 1.8i-1.90 & TD-2 QI-2 16S(93-94), Activa Citroën BX(83), BX 16V(88-), Citroën C3, Citroën C5(front calliper-left hand wheel), Citroën C5 (front calliper-right hand wheel), Citroën C5 rear callipers push-back pistons.
809007-9	11 Disc	Jaguar S Type
809007-10	12 Disc	BMW, Mini
809007-20	J Disc	Alfa Romeo 155 1.8-2.0i 164TD(93), 164 3.0 V6(91), Audi 80, 90 & V8's, A3, A4, A6, A8(rear calliper), Citroën ZX 2.0i 16V, Fiat Tipo TD 16V, Uno Turbo(85) TD, Ford Sierra(ABS back), Granada(85-), Ford(Australia&NZ) Thunderbird Turbo, Honda CRX 1.6i-16V(88-90), Accord 1800(84-85), 2.0i(86-), Prelude 16V(88-), Legend V6, Jaguar XJ 40 Series, Lancia Dedra 2.0 Ei Tur(93), Delta 1.6Gti(92), The majE 16V(92), Thema 2000 Turbo, Kappa 2.0-2.4LS, 2.4TD, Nissan 280 ZX (82-84), 300 ZX Turbo(84-89), Bluebird 16V(89-), Silvia 1.8 Turbo (85-88)100NX 2.0(93), Primera 2.0GT(94-), 200 SX Turbo 16V, Maxima 2.0 GX 3.0, GX(95), Peugeot 306, Peugeot 309Gti 16S (91), 405 Sfrif Q,r,i,Gti(87-), 405 M.I 16V, Renault Master Van, Rover 216 Gti 16V, 820 Si 2.0(93), 825 SD 2.5(93), Saab 9000 CS 2.0(93), 9000 CSE Turbo (93), Seat Toledo GT 16V, GT 2.0 (93), Ibiza 1.8 Gti 16V(93), Subaru L-serie & Serie 2, Volkswagen Passat 2.0&2.2 Liter(84), Golf Rally(89), Golf II Gti 16V(89), Vento GT(92), Transporter T4-A&D, Volvo S40&V40
809007-21	K Disc	Citroën C5 rear callipers push-back pistons
809007-22	K1 Disc	Citroën C5 (front calliper-left hand wheel), Citroën C5 (front calliper-right hand wheel)
809007-23	K2 Disc	Audi A8,S8(99-)
809007-24	M Disc	Nissan Primera 03
809007-25	N Disc	Alfa Romeo 164 2.0, Twin Spark 2.0, Turbo(8-), 3.0 V6, Audi 200(80-), Coupe GT SE(82-), 80, 90i Q0, 200, Quattro(87), 90,20V(88-), Ford Mondeo 2.0 Ghia, Lancia, Themaalte(86-), Volkswagen Golf II GTI (83-87), Scirocco 16V(84)
809007-28	P Disc	Citroën C3
809007-29	R Disc	Ford (Australia&NZ), Telstar, Laser, Mazda 323 Gti, GTX (86-), 929 (82-), RX7(81-), 626 16V (87-), 626 GT(86-), 929 V6(88-), Mitsubishi Galant GL Si, Toyota Celica, Corolla GT, MR2
809007-30	S Disc	Audi 100TQi(91), BMW 740i 8cyl.(91), Lancia Delta 1.9 TD(95), Proton 416, Renault-most models, Renault Laguna 2.0(94), Laguna 2.2D(95), Safrane 2.0-2.2 TD V6, Rover 623 Si, Volkswagen Golf Gti MK III&IV, Passat VR6, Vento GT(92)
809007-31	Z Disc	BMW MINI
809007-18	H6 Disc	BMW-most models (push-back pistons), BMW 740i 8cyl.(91), BMW Mini, Vauxhall Astra G,Zafira
809007-19	H7 Disc	BMW-most models (push-back pistons), BMW 740i 8cyl.(91), BMW Mini, Vauxhall Astra G,Zafira
809007-26	P3,0 Disc	Opel AstraC Zafira(with Bosch rear calipers), Opel Astra G, Corsa C, Zafira (with Lucas TRW rear calipers 02) Opel Vectra 02, Vauxhall Astra G, Zafira
809007-27	P5.5 Disc	Opel AstraC, Zafira(with Bosch rear calipers), Opel Astra G, Corsa C, Zafira(with Lucas TRW rear calipers 02)Opel Vectra 02, Vauxhall Astra G, Zafira

ART. NO.	DESCRIPTION	SUITABLE FOR
1pc	Pentagon brake socket: 1/2" x 19mm	For use on bendix brakes
1pc	Pentagon brake socket: 1/2" x 14mm	For use smart car
1pc	Pentagon brake socket: 1/2" x 10mm	For use on girling brakes
809007-32	Flexible pot for grease	Flexible pot for grease
809007-11	A Disc	Nissas Primera 2.0, Opel Astra, Zafira(with bosch rear calipers), Vauxhall Astra G. Zafira
809007-12	B Disc	Ford(USA) Mercury, Monarch, Thunderbird, Lincoln, Continental Subaru 1600 Kombi (79-),1.6-1.8 SRX, kombi(79-83),1800(84),1800 lim, Kombi, Turismo 4WD (82-83),1800gt, GTSXT, turbo(85)
809007-13	C Disc	Nissan Primera(02), Opel Vectra 02, Toyota Avensis
809007-14	D Disc	Citroën BX(83), BX 16V(88-)
809007-15	E Disc	Nissan Maximas
809007-16	F Disc	Peugeot 206 '03
809007-17	G Disc	Fiat Stilo

805002 - BRAKE CALIPER SET, 27-PCS

 - 1 right rotating caliper (with right side thread) - 1 disc
 - 1 left rotating caliper (with left side thread) - 5-13/32" Adaptor(5) with 3/8" inner 4-pt.

ART. NO.	DESCRIPTION	SUITABLE FOR
805002-1	0 Disc	GM Motors
805002-2	2 Disc	Citroën XM, Xantia u.a.
805002-3	3 Disc	Alfa Romeo, Audi, Austin, BMW, Ford, Honda, Jaguar, Mercedes-Benz, Mitsubishi, Nissan, Rover, Toyota, VW
805002-4	4 Disc	Alfa Romeo 164 2.0, Ford, Mazda, Saab 9000, Subaru
805002-5	6 Disc	Nissan Primera, VW-Golf IV
805002-6	7 Disc	Audi 80,90,V8 +100, Ford Sierra ABS+Scorpio ab 85, Honda Prelude, Nissan Silvia 1.8 turbo, Rover 8000, Saab 9000, Subaru L+Z, VW Golf, Passat
805002-7	8 Disc	GM Motors
805002-8	9 Disc	GM Motors
805002-19	M Disc	Ford
805002-20	N Disc	Saab, Honda
805002-13	E Disc	Cefiro, Maxima
805002-15	G Disc	Opel
805002-21	0 Disc	Citroën
805002-16	K Disc	Citroën C5
805002-17...18	K1, K2 Disc	Citroën, Renault
805002-9	A Disc	Nissan Primera 2.0, Bluebird
805002-10	B Disc	Ford, Lincoln, Subaru
805002-11	C Disc	Mini, Austin
805002-12	D Disc	Citroën, Renault
805002-14	F Disc	Peugeot 206 cc/Hdi,Gti. A 16mm spanner is required with wind back pistons
805002-22	P Disc	Audi, BMW, Ford, Lancia, Proton, Renault, Rover, VW
805002-23	Z Disc	Renault

Sonic special tools

812006 - BRAKE PISTON REWINDING CUBE



Universally applicable for winding back brake pistons on hand-brake secured brake calipers

820017 - WIRE BRUSH SET, 20-PCS



- Stainless Steel, Brass and Nylon 3 type brushes
- Comprising 9, 11, 13, 15, 17, 19mm diameter for each brushes
- All brushes adopt 1/4" quick driver for power tools
- Install the brushes on extension rod for increased reach
- Ergonomically handle for easy use

820007 - CLEANING BRUSH KIT, 38-PCS



Comprising a handle with extension and 36 assorted brushes with 1/4" drive and 8, 9, 10, 11, 12, 13, 14, 15, 16, 17, 18, 19mm diameter for cleaning and deburring cylinders, bushings, pipes and other work pieces with nylon, brass and steel facing.

APPLICATION EXAMPLES ARE:

- Brake callipers sleeve
- O-ring cut-ins
- Injector seat
- Valves on exhaust gas recirculation
- Inlets and outlets
- Crossbar seal on injection lines on Opel cylinder heads

825001 - CLAMP TENSIONER CV BOOT TOOL



- For 1/4" - 3/8" bands and clamps
- Ratchet tension winding mechanism, no need to use extra tools
- Built-in cutter to cut the band to appropriate length

829002 - DIESEL INJECTOR SEAT CLEANER SET, 14-PCS

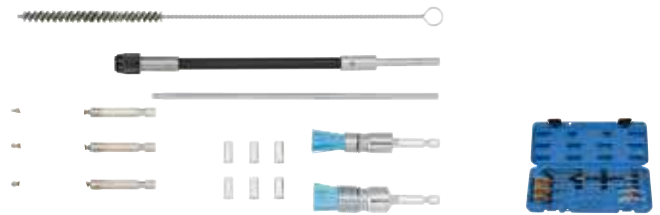

ART. NO.	DESCRIPTION
829002-01	[A]Injector nozzle port cleaner
829002-02	[B][C][D]Cleaning brush (inner injector port) 18/22/25mm
829002-03	[H][I]Cleaning brush (base/injector seat area) 15/20mm
829002-04	[E]Quick chuck 224mm flexible extension
829002-05	[F]Insertion rod for "Injector nozzle port sealing plugs"
829002-06	[G]Injector nozzle port sealing plugs (6 pcs)

816001 - TWO SETS GEAR & BEARING SPLIT TOOLS



Mechanical puller set with Ø30-55mm and Ø50-75mm separators and single yoke with 180mm thrust bolt.

SUITABLE FOR ENGINEERING AUTOMOTIVE, MARINE AND AGRICULTURAL APPLICATIONS.

- Bearing separator & bolts: 1 set
- S45C drop forged hardened 42° - 45°
- Capacity range: 30 - 50 mm
- Bolt 3/8" x L 120mm x 24t S45C hardened 42° - 45°

- Bearing separator & bolts: 1 set
- S45C drop forged hardened 42° - 45°
- Capacity range: 50 - 75 mm
- Bolt 1/2" x L 135mm x 20t S45C hardened 42° - 45°

- Main rod: 4 pieces hex bar 17mm 3/8" x L125mm x 16t

- Extension rod: 4 pieces
- Hex bar 14mm 3/8" x L110mm x 16t

- Centre bolt: 1 piece
- 5/8" x L 175 x 18t/inch carbon steel

- Beam: 1 piece
- Carbon steel

805018 - CLAMP TENSIONER CV BOOT TOOL



- Testing range 0-2.5 bar
- Suitable for all standard vehicles

832001 - HEAT GUN 1800W



High quality heat gun with extensive temperature and airflow control with 3 air flow rates. Incredibly strong 1800W-motor, which can be quickly reach a temperature of 550°C. The heat gun has an improved thermal safety: the gun will be switched off automatically when the motor overheats.

- Nominal power consumption: 1800Watt
- Power supply: 220-240V / 50-60Hz
- Length cable: 2m

Working temperature and airflow infinitely adjustable in 3 positions:

- Position 1: 50 °C / 250 l/min
- Position 2: 450 °C / 250 l/min
- Position 3: 550 °C / 500 l/min
- 4 mouthpieces included

832002 - HEAT GUN WITH DIGITAL DISPLAY 2000W



High quality heat gun with extensive temperature and airflow control. Two infinitely adjustable air flow rates and a digital display with memory function. Incredibly strong 2000W-motor, which can be quickly reach a temperature of 650°C. The heat gun has an improved thermal safety: the gun will be switched off automatically when the motor overheats.

- Nominal power consumption: 2000Watt
- Power supply: 220-240V/50-60Hz
- Length cable: 2m

Working temperature and airflow adjustable in 2 positions: 50 - 650°C

- Position 1: 50°C / airflow 250-500 l/min
- Position 2: 50-650°C / airflow 250-500 l/min
- 4 mouthpieces included
- Will be delivered in hard case

301302 - CRAWFOOT SET 1/2", 13-PCS



Ideal for injection lines, air-conditioning systems, brake lines, compressed air and hydraulic lines, oil pressure switches, 12,5 mm (1/2")

ART. NO.	DESCRIPTION
301302-1	Swivel handle 1/2" 385mm
301302-2	Extension 1/2" 125mm
301302-3..13	Crawfoot 1/2", 20, 21, 22, 23, 24, 25, 26, 27, 28, 30, 32mm

814... - TORQUE MULTIPLIER



- Accuracy +5%
- Heavy-duty construction reduces maintained procedures
- Precision gear mechanism applied high torque output with low input
- Supplied to react accessories for combined

ART. NO.	DESCRIPTION	SPECIFICATIONS
814001	Torque Multiplier 1500Nm / 1250Ft-lb	- Input square: 1/2" square (F) - Output square: 3/4" square (M) - Maximum range: 1500nm/1250ft-lb - Ratio: 5:1 - Gear ration: 1: 4.33 - Tool weight: 3.5kg - Reaction accessory: 2-pcs - Surface finished: matt
814002	Torque Multiplier 2700Nm / 2000 Ft-lb	- Input square: 3/4" square (F) - Output square: 1" square (M) - Maximum range: 2700Nm/2000ft-lb - Ratio: 5:1 - Gear ration: 1: 4.33 - Tool weight: 3.5kg - Reaction accessory: 2-pcs - Surface finished: matt

812001 - WIPER REMOVAL KIT

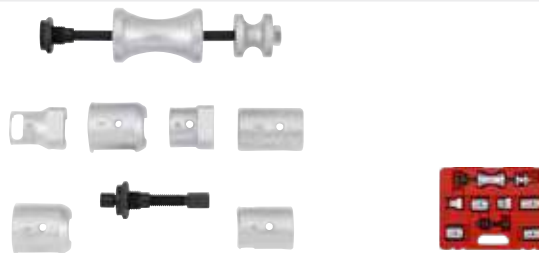

ART. NO.	DESCRIPTION
812001-1	Extractors size 1
812001-2	Extractors size 2
812001-3	Extractors size 3
812001-4	Extractors size 4
812001-5	Extractors size 5
812001-6	Extractors size 6
812001-7	Remover
812001-8	Pressure spindle

808001 - SLIDE HAMMER PULLER SET



This most useful tool can pull flange-type rear axles, remove stubborn oil seals & bearing or press-fit parts. Use as a dent puller or lip puller, reversible jaws can be set up for 2/3 jaw in-external usage, 1/2"-20 thread adaptor expands the slide hammer for extra pulling functions.

Sonic special tools

47401 - BALL JOINT SEPARATOR (JAW 20MM)



47402 - BALL JOINT SEPARATOR (JAW 20MM)



- For splitting track-rod ends, anti-toll bar mountings, ball joints, etc.
- Jaw open: 20mm

47403 - BALL JOINT SEPARATOR (JAW 22MM)



- Suits most cars and lighttrucks ball joints in steering & suspension
- 2-stage, 30-50mm
- Jaw open: 22mm

47404 - BALL JOINT SEPARATOR (JAW 22MM)



- For splitting track-rod ends, anti-toll bar mountings, wheel-hub ball joints, etc.
- 2-stage, 50-80mm
- Jaw open: 22mm

48307... - REVERSIBLE PULLER



- Jaws grip tighter as more pressure is applied
- Reversible jaws
- Drop forged
- Alloy steel
- Hardened 45° hrc

ART. NO.	DESCRIPTION	SPECIFICATIONS
4830703	2-3 jaw 3" reversible puller	- Spread: 4" - Reach: 2-1/2" - Capacity: 2 ton
4830704	2-3 jaw 4" reversible puller	- Spread: 6" - Reach: 3-1/2" - Capacity: 5 ton
4830706	2-3 jaw 6" reversible puller	- Spread: 8" - Reach: 3-1/2" - Capacity: 5 ton

820019 - MULTI-PURPOSE SYRINGE 500ML



820018 - 2 MEGAPIXELS WIFI ENDSCOPE WITH LED OD 5.5MM CAMERA 8-PCS



This endoscope is a must have for the modern service and diagnostic mechanics.

- This rechargeable endoscope can be connected with your smartphone or tablet through its own WiFi-connection
- Camera diameter is 5,5mm and is equipped with adjustable LED-lighting
- With the record button, video's and or pictures can be made of inspected objects
- The camera can be supported with a mirror, which allows angle inspection
- The camera can also be equipped with a hook or magnet so objects can be removed directly from inspected areas
- Length of flexible camera probe is 3,5m
- The 2.0 megapixel camera is protected according to IP68

47242 - PROFESSIONAL CAR SHEET COVER, MULTI USE



- Nylon with elastic band
- Wash on 40 degree
- Black with white Sonic logo

48104 - FENDER PROTECTOR WITH SUCTION CUPS



- Length: 106,5cm
- Width: 64cm
- Weight: 380gr

47570 - NON SLIP WING & GRILL COVER



- The issues arising of using magnetic wing covers can now be prevented by our new non slip wing cover
- The wing will protect the vehicle against scratches and damage
- Washable at 40°C
- Oil, grease, dirt and water repellent
- Meets national and international fire safety standards
- Size: 90 x 50 cm (wing cover)

47571 - FENDER PROTECTION SYSTEM



- Protects the vulnerable areas of the bodywork (front grill, fender, headlights, car make badges, bumper, ...) during general service, inspection, mobile airco service,...
- Universal vehicle fit: one size fits all - from mini to estate
- Unique wheel access: allows maintenance on brakes, suspension
- Front lamp section with nylon mesh allows light testing without overheating
- Radiator section with nylon mesh allows stationary motor testing without the risk of overheating
- Unique removable protective fabric panel (washable) to prevent rubbing/damage when the mechanic leans onto the engine bay
- Comes in a convenient storage bag
- Backside made of 420D nylon, antislip. Attach with elastic loops.

48105 - CREEPER



- Length: 100cm
- Width: 48cm
- Height: 11,5cm
- Wheels also loose available; article number 48105W

48126 - PNEUMATIC ROLLER SEAT, 5 WHEELS



Adjustable height 375-495mm

4821901 - MULTI PURPOSE PAN BLACK, 20 LITER



- Pan volume 20 ltr.
- Drain spout
- Loop for pulling and hanging up the pan
- Dimensions approx. 685 x 667 x 65mm (L X W X H)

4821902 - MULTI PURPOSE PAN BLACK, 50 LITER



- Pan volume 50 ltr.
- Drain spout
- Dimensions approx. 800 x 600 x 100mm (L X W X H)

Sonic special tools

48112 - HEAVY DUTY OIL DRAIN PAN 15.9 LITER



For professionally changing of motor oils, cleaning of parts or collecting other liquids. This drain pan includes a nozzle for easy pouring of the contents. With three grips this drain pan is comfortable to use.

- Easy pouring no mess spout
- Convenient front and rear handles
- 15.9 liter
- Extra thick quality

818003 - BELT GAUGE



- This tensioning gauge can be used to adjust the tension on the cam belts where the movement of the timing belt is measured by load
- Suitable for use on cam belts with various belt thickness
- Clear incremental marking with knurled knob for precise measurement
- Dual scale allows reading from top or bottom of tool

487001 - MAGNETIC TRAY 4", 15CM



487002 - MAGNETIC TRAY 4", 15CM



818001 - CLUTCH ALIGNER SET, 15-28MM



As a result of parallel expansion technique it is possible to align the clutch plate to the pilot bearing in the crankshaft flywheel. For clutch-hub- \varnothing 15 - 28mm

815002 - MAGNETIC BOWL, DIAMETER 150MM



818008 - CLUTCH ALIGNMENT TOOL SET, 38-PCS



Tool set for professional dismantling and assembly of self adjusting clutches. Prevents plate distortion which may prevent the clutch from disengaging of cause dragging. Consists a refitting tool, allowing the clutch adjuster to be wound back, and six alignment adaptors.

818002 - OXYGEN SENSOR WRENCH



- 6 pt. wrench 22mm with flexible head
- 250mm
- Suitable for heated and unheated oxygen sensors
- Cut-out section allows socket to pass over wiring
- Suitable for VW, Audi, BMW, Mercedes, Ford, Opel/Vauxhall, Peugeot, Citroën, Renault, Seat, Skoda, Japanese cars

810005 - OXYGEN SENSOR SOCKET 1/2", 22MM



Extra long, slitted version for deeply ingrained oxygen sensors, suitable for:

- BMW, Ford, Mercedes, Opel, VAG, etc.
- 150mm, 22mm

829003 - DIESEL INJECTOR EXTRACTOR WITH ADAPTORS



Essential set to remove injectors from the cylinder head professionally.

ART. NO.	DESCRIPTION
829003-01	Empty case 829003
829003-02	Foam 829003
829003-03	Air hammer extractor
829003-04	(A) diesel injector adaptor - Siemens
829003-05	(B) diesel injector adaptor - Denso
829003-06	(C) diesel injector adaptor - Siemens
829003-07	(D) diesel injector adaptor - High Pressure M12
829003-08	(E) diesel injector adaptor - Delphi
829003-09	(F) diesel injector adaptor - Off-line
829003-10	(G) valve seat removal tool - Denso [1.43usd]
829003-11	(H) M16 denso adapter
829003-12	(I) dual connection adaptor - Bosch
829003-13	(J) Bosch injector dismantling tool

818004 - DIESEL INJECTOR SEAT CLEANER SET 7-PCS

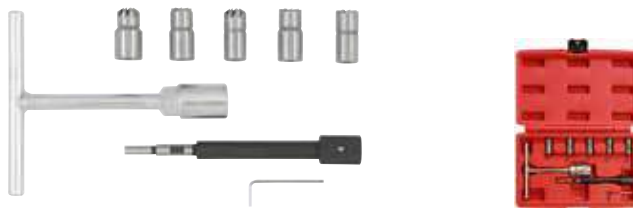

Set of five diesel injectors seat cleaners a centering pilot and T-handle. Use to clean/decarbonise injector seats when changing injectors. Helps to avoid blow-back due to poorly seated injectors.

ART. NO.	DESCRIPTION
818004-1	T-handle
818004-2	Pilot post
818004-3	15mm flat reamer
818004-4	17mm flat reamer
818004-5	17mm angled reamer
818004-6	17mm x 19mm flat reamer
818004-7	17mm x 21mm angled reamer

805012 - INJECTOR/INJECTOR-EXTRACTION TOOL SET



Specially for VW/Audi/Seat/Skoda, suitable for
 - SDI-/TDI- und TFSI- diesel engine (also pump/nozzle and common rail)
 - FSI gasoline engines
 For the professional dismantling and installation of injectors/injection valves as well as the unit pump nozzle. The striking weight also enables the removal of jammed elements.

818009 - COMMON RAIL FLOW METER SET

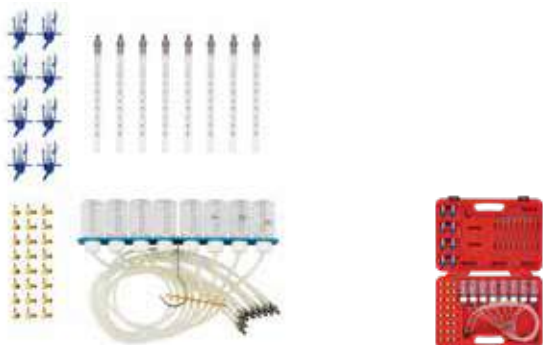

- To measure return fuel flow on diesel vehicles up to 8 cylinders fitted with common rail injection system
- Determination of the runback volume via glass tubes or measurements cartridges
- Includes 8 glass tubes, 8 measurements cartridges with connecting lines, mounted on an aluminum bar

819005 - COMMON RAIL FLOW METER SET

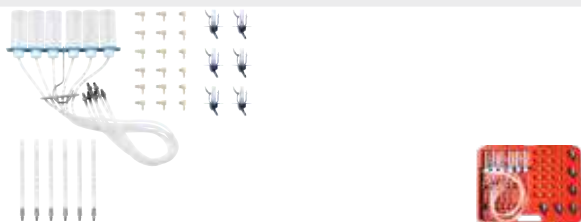

- To measure return fuel flow on **diesel** vehicles up to 6 cylinders fitted with common rail injection system
- Determination of the runback volume via glass tubes or measurements cartridges
- Includes 6 glass tubes, 6 measurements cartridges with connecting lines, mounted on a aluminum bar

818011 - OIL PRESSURE TEST SET

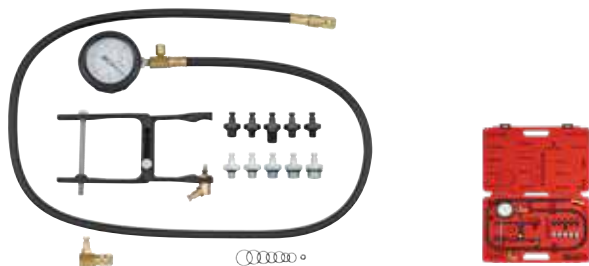

Tests oil pump pressure and also low oil warning devices. Ø75mm gauge fitted with heavy duty cover. Fitted with quick coupling adaptors and 1200mm hose. Includes 90° coupling adaptor for limited access applications.

818010 - MASTER COMPRESSION TEST SET



A comprehensive set for testing the compression on diesel vehicles. Features 600psi gauge with large rubber bumper, straight and right angled quick connect fittings and an extensive range of spark/glow plug and injector adaptors.

- Spark plug sizes: 10, 12, 14, 18mm
- Glow plug adaptors: Alfa Romeo, BMW, Chrysler, Citroën, Daewoo, Fiat, Ford, Honda, Hyundai, Isuzu, Jeep, Kia, Lada, Lancia, Land Rover, LDV, Mazda, Mercedes, MG, Mitsubishi, Nissan, Peugeot, Renault, Rover, Saab, Ssangyong, Suzuki, Toyota, VAG, Vauxhall/Opel, Volvo
- Injector adaptor: M20, M22, M24 & Ford Stanadyne injectors plus clamp-on injectors

Sonic special tools

818016 - CAMSHAFT & CRANKSHAFT LOCKING SET, 19-PCS



Anodized aluminum chocks suitable for locking camshaft pulleys on twin cam engines. Allows the service easier and reduce the risk of incorrect valve timing from taking place. Set includes flywheel locking tools for selected PSA (Citroën/ Peugeot) and GM (Vauxhall/Opel) petrol and diesel engines. Suitable for a range of vehicles including: Ford, Honda, Land Rover, Rover, VW, Renault, Citroën, Peugeot, Fiat and Vauxhall/Opel.

ART. NO.	DESCRIPTION
818016-1	A. camshaft setting and locking plate
818016-2	Q. balancer shaft locking pin
818016-3	D. crankshaft tdc location pin
818016-4	N. camshaft locking pins (5.0mm, pair)
818016-5	P. camshaft locking pins (6.8mm, pair)
818016-6	K. flywheel holding tool
818016-7	M. flywheel holding tool
818016-8	B. camshaft locking tool
818016-9	C. camshaft locking tool
818016-10	D. camshaft locking tool
818016-11	E. camshaft locking tool
818016-12	F. camshaft locking tool
818016-13	G. camshaft locking tool
818016-14	H. camshaft locking tool
818016-15	I. camshaft locking tool
818016-16	J. camshaft locking tool
818016-17	L. camshaft locking tool

819009 - CYLINDER PRESSURE METER SET



Quick connect/disconnect feature allows one gauge to be used with variety of quick adaptors for most popular diesel engines. Push pressure scale: 0->1000PSI 0->70 Bar

47815 - DOUGHNUT STRETCHER

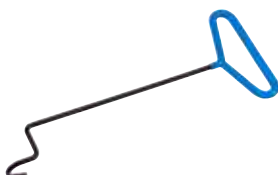

For removing the retaining rubbers on exhaust systems

826001 - VACUUM PUMP SET



For universal use, for building up pressure and vacuum. Complete with hose and various couplings in a case. Ideal for brake and clutch bleeder and to bleed the fuel system as at (ISA) V6 TDI engines as well as for testing.

- Vacuum cells e.g. on air-conditioning systems
- Turbochargers etc.
- Vacuum - 0,8 bar
- Pressure - 4 bar

818014 - RADIATOR PRESSURE TEST SET, 17-PCS



- Testing range 0-2,5 bar
- Suitable for all standard vehicles

818017 - TOOTH BELT TOOL SET, 3-PCS



- Set for working and locking the tooth belt tensioner rolls
- Timing belt tensioner pins-OEM Nos T10115, T40011 and serpentine tension pin-T10060/A.
- For use on: Lupo, Polo 1.4 TDi PD Golf, Bora, Polo 1.9 TDi PD, Beetle, Sharan 1.9 TDi PD, Passat 1.9 TDi PD, Audi A2 / A3 1.4 / 1.9 TDi PD, A4 / A6 1.9 TDi, A4 / A6 / A8 / Allroad 2.5 V6 TDi.

818015 - PETROL ENGINE COMPRESSION TEST SET



Compression tester fitted with Ø63mm gauge reading up to 300psi and 20kg/cm². Set includes 130mm straight and angled push-on connectors, 400mm flexible extension with 10, 12, 14 and 18mm adaptors.

47816 - FITTING HOOK



Perfect for the removal and fitting of springs on brakes, headlights, motorbike mufflers and much more. The bent shape of the fitting hook allows a free view of the fitting spot.

820006 - AXIAL JOINT TOOL SET, 30-45MM



- For fast and professional changing of the axial joints of cars
- Automatic clamping of the joint heads
- Easy assembling of long tie rods because of open construction
- Saves up to 3 hours of working time
- For joint heads Ø30-35mm, Ø35-40mm and Ø40-45mm

ART. NO.	DESCRIPTION
820006-1	Axial joint tool
820006-2	Joint heads Ø30-35mm
820006-3	Joint heads Ø30-40mm
820006-4	Joint heads Ø40-45mm

819001 - NUT BREAKER SET, 4-PCS



- For the splitting of seized and/or overtightened nuts without damaging the thread
- Flat round head design allows tool to be used in inaccessible areas drive to prevent binding under load
- Does not damage the bolts threads

ART. NO.	DESCRIPTION
819001-1	5/16" - 1/2" (9-12mm)
819001-2	1/2" - 5/8" (12-16mm)
819001-3	5/8" - 7/8" (16-22mm)
819001-4	7/8" - 1.1/8" (22-27mm)

818021 - BLIND HOLE BEARING PULLER SET

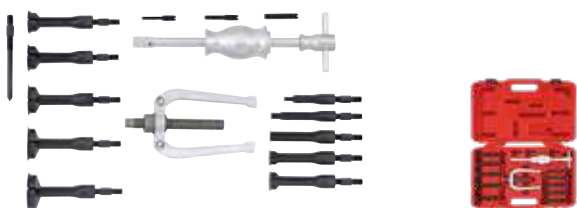

- 10-PCS clamps: 8-11mm, 12-17mm, 18-23mm, 24-29mm, 30-34mm, 34-37mm, 39-42mm, 44-47mm, 49-52mm, 54-57mm
- 3PCS screw: M10xP1.5, M10xP1.5 & M8xP1.25, M10xP1.5 & M6xP1.0
- One slide hammer
- One two jaw puller

ART. NO.	DESCRIPTION
818021-1	One slide hammer
818021-2	One two jaw puller
818021-3	Clamp 8-11mm
818021-4	Clamp 12-17mm
818021-5	Clamp 18-23mm
818021-6	Clamp 24-29mm
818021-7	Clamp 30-34mm
818021-8	Clamp 34-37mm
818021-9	Clamp 39-42mm
818021-10	Clamp 44-47mm
818021-11	Clamp 49-52mm
818021-12	Clamp 54-57mm
818021-13	Screw M10xP1.5
818021-14	Screw M8xP1.25
818021-15	Screw M6xP1.0

819002 - FORK ROD SET, 5-PCS



Forks made of drop forged heavy duty chrome vanadium steel

ART. NO.	DESCRIPTION
819002-1	1 handle for use with pneumatic air hammer
819002-2	Both handles are interchangeable
819002-3	Drop forged forks 11/16"
819002-4	Drop forged forks 15/16"
819002-5	Drop forged forks 1-1/8"

818028 - SEPARATING AND MOUNTING FORK 16"

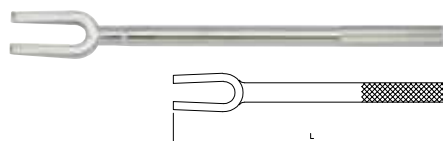

- For tie-rod ends and steering column stalk
- 410mm

805017 - UNIVERSAL HEAVY DUTY PULLER SET, 12-PCS



- Forged, chrome-molybdenum steel, 2 and 3-arm can be used
- 100 - 200 - 250 mm clamping width
- Can be used as inner and outer remover
- Replaceable, hardened remover bases (ca. 25 mm)
- Clamping width max. 130 mm

Sonic special tools

818023 - TEST LEAD SET, 92-PCS



Comprehensive set of test leads and components suitable for testing, isolating and evaluating automotive electronic circuits. Set includes standard Ø24mm banana style plugs and sockets suitable for use with most diagnostic multi-meters and test equipment.

818025 - FUEL & AIR CONDITIONING TOOL SET, 22-PCS



Comprehensive kit for separating air conditioning hoses and fuel lines. Suitable for a wide variety of vehicles.

ART. NO.	DESCRIPTION
818024-1	Coupling tools 3/8"
818024-2	Coupling tools 1/2"
818024-3	Coupling tools 5/8"
818024-4	Coupling tools 3/4"
818024-5	Color coded disconnecting 5/16"
818024-6	Color coded disconnecting 3/8"
818024-7	Color coded disconnecting 1/2"
818024-8	Color coded disconnecting 5/8"
818024-9	Color coded disconnecting 3/4"
818024-10	Color coded disconnecting 7/8"
818024-11	Fuel line disconnect tool
818024-12	Ford oil cooling line disconnect tool
818024-13	Ford oil cooling line coupling tool
818024-14	Ford/Vauxhall/Opel quick disconnect tool
818024-15	Disconnecting 1
818024-16	Disconnecting 2
818024-17	Disconnecting 3
818024-18	Disconnecting 4
818024-19	Disconnecting 5
818024-20	Disconnecting 6
818024-21	Disconnecting 7
818024-22	Spare rubber bands

805007 - TERMINAL RELEASE TOOL SET, 16-PCS



- These tools are spring loaded to assist the removal on Citroën, Peugeot and Renault vehicles
- Simply pull the tool and bend, releasing the side locking slot
- For damage free releasing of plug type connectors with folding/sheaths to protect the user and the fine precision tips
- Blow mould case supplied with positional insert for easy identification of missing tools

ART. NO.	NO.	DESCRIPTION	SUITABLE FOR
805007-1	CE-01, CE-11	Ejection tools for contact sizes Ø1.5mm with dismantling sleeves for contact sizes	BMW, Daimler, Fiat, MAN, Opel, Porsche, Seat, Skoda, VW/Audi
805007-2	CE-02, CE-12	Ejection tools for contact sizes Ø3.5mm with dismantling sleeves for contact sizes	BMW, Daimler, Fiat, MAN, Opel, Porsche, Seat, Skoda, VW/Audi
805007-3	CE-05, CE-15	Ejection tools for contact sizes Ø2.3mm with dismantling sleeves for contact sizes	Ford, Opel, PSA, Renault
805007-4	CE-53	Cable extractor tool for plugs with one release channel 2.8 and 5.8mm	BMW, Daimler, Ford, MAN, Opel, Porsche, PSA, Renault, Seat, Skoda, VW/Audi
805007-5	CE-54	Cable extractor tool for plugs with one release channel 2.8mm	BMW, PSA, Renault
805007-6	CE-56	Cable extractor tool for micro-timer II, III contacts Ø1.6mm	Daimler, Opel, Porsche, PSA, Renault, Saab, Seat, Skoda, VW/Audi
805007-7	CE-56-1	For flat plug-in sockets with asymmetrically positioned latches in terminals with two release channels	Seat, Skoda, VW/Audi.
805007-8	CE-57	For flat plug-in sockets with asymmetrically positioned latches in terminals with two release channels	Seat, Skoda, VW/Audi
805007-9	CE-58	For flat plug-in sockets with asymmetrically positioned latches in terminals with two release channels	Seat, Skoda, VW/Audi
805007-10	CE-59	Cable extractor tool for Maxi-Power Timer contacts 9.5mm	Daimler, VW/Audi
805007-11	CE-62	Cable extractor tool for Pit-Pod contacts	All vehicle makes
805007-12	CE-74	Cable extractor tool for Micro-Timer I contacts and ABS plug-in housing Ø1.6mm	Fiat, Ford, Mazda, Opel, PSA, Renault, Saab, VW/Audi
805007-13	CE-91	Cable extractor tool for plugs with two release channels 2.8 and 5.8 mm	BMW, Daimler, Fiat, Ford, MAN, Opel, PSA, Renault, Saab, VW/Audi

819008 - VALVE SPRING COMPRESSOR SET



- To remove and install the valve spring with the cylinder head on or off the OHV & OHC petrol or diesel engines
- An ideal tool kit for most of engines
- The multi-point adjustable base of this tool bolted securely to the head while the adjustable lever mechanism pivots form the beam. Thus, compress the spring quickly by one hand operation
- Fast remove and install of the spring retaining keeper. Then easily accomplished through the large open on both sides of the compressing tube

48215... - TIE-RAPS

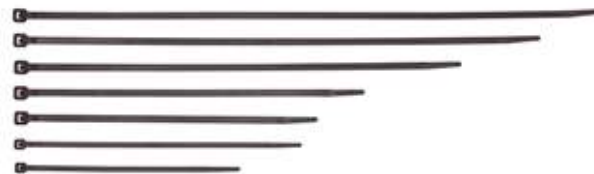

ART. NO.	DESCRIPTION
4821511	Tie-raps 3,6x140; 100-pcs in bag (black)
4821512	Tie-raps 3,6x180; 100-pcs in bag (black)
4821513	Tie-raps 4,8x190; 100-pcs in bag (black)
4821514	Tie-raps 4,8x220; 100-pcs in bag (black)
4821515	Tie-raps 4,8x280; 100-pcs in bag (black)
4821516	Tie-raps 4,8x330; 100-pcs in bag (black)
4821517	Tie-raps 4,8x370; 100-pcs in bag (black)

4822332 - TYRE CARRIER CADDY

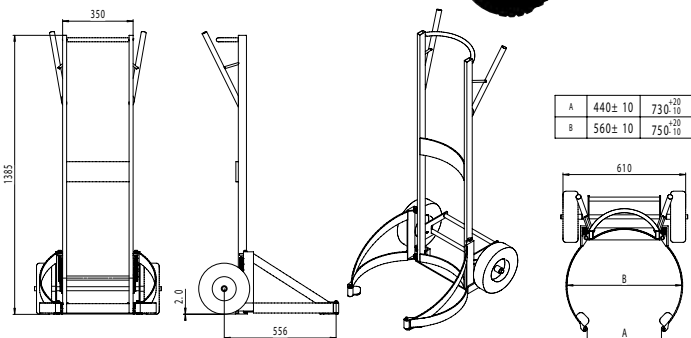

This long life, light weight, high capacity cart allows the tire fitter to maneuver heavy wheel sets in the most ergonomic way with the help of its patented lifting system. The unique push-slide-secure automatic locking system eliminates the need for inefficient, wear sensitive, foot operated - or hand controlled jaws. The black colored foam filled tires are maintenance free and leave no traces on the work shop floor. The wheels run on industrial bearings. It comes in stainless steel (robotic welding) with high strength components and an exceptional 3 year warranty period. With just 17KG this lightweight cart handles wheels from 13"-20" up to 200KG.

48217... - NITRILE COATED GLOVE



- Nylon with nitrile coating
- The nitrile coating is fluids resistance
- For better fit and more comfort, only the gripping part is coated
- Breathable and an ergonomic fit due to partly coated finger tips
- EN388 and 3142 European standards

ART. NO.	DESCRIPTION
4821701	Nitrile coated glove size 8 (medium)
4821702	Nitrile coated glove size 9 (large)
4821703	Nitrile coated glove size 10 (extra large)

47025 - KNEE PAD



Measurements: 475x235x30mm

Sonic special tools

47035 - DIGITAL MULTIMETER AC/DC



47036 - DIGITAL MULTIMETER 3 IN 1



07

FEATURES	SPECIFICATIONS
<ul style="list-style-type: none"> - 3 1/2 digits LCD (max. reading 1999) - Low battery indication - Overload protection - CAT III 300V 	<ul style="list-style-type: none"> - Voltage DC: 200m/2/20/200/300V - Voltage AC: 200/300V - Current DC: 2mA/20mA/200mA/10A - Resistance: 200-2K-20K-200K-2000K - Battery check: 1.5V,9V - Continuity: No - Diode check: Yes - Power source: 9V battery (6F22) x1 - Dimensions: 138x70x28mm - Weight: 141g (with battery)

FEATURES	SPECIFICATIONS
<ul style="list-style-type: none"> - LCD display (max. reading 3999) - 3/4 Backlight - Data-hold function - Auto polarity indication - Manual range and auto range mode - Auto/manual power off - Relative mode - Overload protection - Low battery indication - CAT III 300V 	<ul style="list-style-type: none"> - Voltage DC: 400m/4/40/300V - Voltage AC: 4/40/300V - Current DC: 400µ/4000µ/40m/400m/4A/10A - Current AC: 400µ/4000µ/40m/400m/4A/10A - Resistance: 400/4K/40K/400K/4M/40M - Capacitance: 40n/400n/4µ/40µ/100µF - Frequency: 10/100/1k/10k/100k/200kHz - Duty cycle: 5%-95% - Temperature: -20°C - 1000°C - Continuity: Yes - Diode check: Yes - Power source: 9V battery (6F22) x1 - Dimensions: 162x83x47mm - Weight: 310g (with battery)

47022 - VOLT CIRCUIT TESTER 6-24V



- Ideal for 6/12 and 24 volt systems on cars, motorcycles and commercial vehicles.
- Will test for live wires, broken wires, bad fuses, brake lights etc.
- The light in the handle will glow if wire is live.
- The tester has a protective cover over a needle probing point to enable you to pierce the insulated sheath and make contact with the copper conductor below to test for broken cables.

ART. NO.	L(MM)	G	PCS/BAG
47022	110	32	1

47019 - VOLT CIRCUIT TESTER



Also available in display with 4 pieces

SPECIFICATIONS
<ul style="list-style-type: none"> - Checks interior and exterior lights - Checks relays and power windows - Test power windows and electric motors - Power supply function when testing shorted or overloaded circuits - Finds open or disconnected parts - Test the positive and negative voltage - Tests continuity in switches, relays, diodes, & fuses, and wiring harnesses - Polarity test cables and sockets - Find short circuits and bad earths fast

47031 - INFRARED THERMOMETER



- Single dot laser
- LCD back light
- Automatic data retention
- Automatic shutdown
- Low battery indication
- 9V battery (included)

Temperature range	-30°C ~ 330°C [-22° F-626° F]
Accuracy	±2% or ±2°C
Resolution	0.1 °C / 0.1 °F
Display selection	°C / °F
Distance spot ratio	10:1
Emissivity	0.95
Response time	500ms
Wavelength	8- 14µm
Max power output	<1 mw class II laser

07

4411001 - HEAD NUT RIVETER

4411002 - RIVETING NUT PLIERS

4411003 - HEAD RIVETER



- Capacity: M6 steel; M5 stainless steel
- Supplied with 4 steel nuts M3 - M4 - M5 - M6
- Max multiple of arm force 35
- Rotary nut loading structure
- Aluminium alloy body
- Chrome molybdenum alloy steel mandrel
- The riveted parts can be replaced without removing the sleeve

- Capacity: Diameter 6.4 mm alu rivets; Diameter 6 mm steel rivets
- Supplied with 5 nosepieces diameter 2.4, 3.2, 4.0, 4.8, 6.4 mm
- Max multiple of arm force 30
- Spent nail core collect
- Aluminium alloy body
- Hexagonal jaw pulldown seat and 3pcs alloy steel jaw makes more durable
- Manual adjustable sleeve makes removing easily without any tool

- Capacity: Ø 5 mm aluminium - Ø 4 mm steel
- Supplied with 4 nosepieces diameter 2.4, 3.2, 4.0, 4.8mm
- Max multiple of arm force 26
- Aluminium alloy body
- Hexagonal jaw pulldown seat and 3pcs alloy steel jaw makes more durable
- Manual adjustable sleeve makes removing easily without any tool

Sonic special tools

4822301 - E-CIRCLIP ASSORTMENT, 300-PCS



- 30x 1.5mm
- 50x 6.0mm
- 20x 1.5mm
- 30x 3.0mm
- 50x 10mm
- 20x 19mm
- 40x 5.0mm
- 40x 12mm
- 20x 22mm

4822302 - SHRINKING HOSE ASSORTMENT, 127-PCS



- 30x Ø2.0 x 40mm
- 16x Ø7.0 x 80mm
- 25x Ø2.5 x 40mm
- 8x Ø10.0 x 80mm
- 20x Ø3.5 x 40mm
- 8x Ø13.0 x 85mm
- 20x Ø5.0 x 40mm

4822303 - W-CLIP ASSORTMENT, 150-PCS

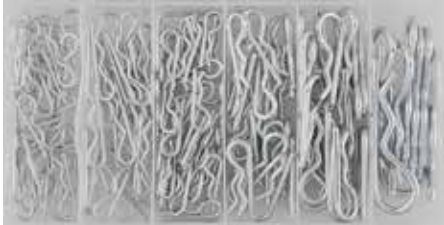

- 30x 2.0 x 33mm
- 25x 2.8 x 41mm
- 25x 2.0 x 40mm
- 20x 3.6 x 44mm
- 42x 2.4 x 30mm
- 8x 4.0 x 75mm

4822304 - SEAL ASSORTMENT, 141-PCS



- Rubber:**
- 5x: Ø8 x Ø14 x 4, Ø8.5 x Ø18 x 4, Ø9.5 x Ø17.5 x 4, Ø10.5 x Ø14 x 4mm
 - 10x: Ø4 x Ø16 x 4, Ø4 x Ø17 x 4, Ø12 x Ø24 x 2, Ø15 x Ø24 x 3mm
- Fibre:**
- 5x: Ø27 x Ø33 x 1.2mm
 - 10x: Ø10 x Ø13.5 x 1.8, Ø11.5 x Ø17.5 x 1.2, Ø17 x Ø21 x 1.2mm, Ø17 x Ø24 x 1.2, Ø20 x Ø25 x 1.2mm
- EVA:**
- 3x: Ø27 x Ø38 x 2, Ø30 x Ø39 x 2mm
 - 10x: Ø12 x Ø17.5 x 2, Ø17 x Ø24 x 2mm

4822305 - O-RING ASSORTMENT, 225-PCS. SUITABLE FOR AIRCO



- | | | | |
|-----|------------|----|-------------|
| 20x | Ø3 x 1mm | 5x | Ø9 x 2mm |
| | Ø4 x 1mm | | Ø10 x 2mm |
| | Ø4.5 x 2mm | | Ø12 x 3mm |
| | Ø5 x 2mm | | Ø13 x 3mm |
| | Ø6 x 2mm | | Ø14 x 2.5mm |
| | Ø6 x 2.5mm | | Ø17 x 2.5mm |
| | Ø6 x 3mm | | Ø18 x 4mm |
| | Ø7 x 2mm | | Ø20 x 2mm |
| | Ø8 x 2mm | | Ø22 x 2mm |

4822306 - SNAP RING ASSORTMENT, 300-PCS



- | | | | |
|-----|-------|-----|-------|
| 20x | Ø3mm | 15x | Ø14mm |
| 10x | Ø4mm | 20x | Ø15mm |
| 15x | Ø5mm | 25x | Ø19mm |
| 25x | Ø6mm | 20x | Ø22mm |
| 15x | Ø8mm | 15x | Ø20mm |
| 20x | Ø9mm | 15x | Ø25mm |
| 15x | Ø11mm | 15x | Ø26mm |
| 15x | Ø12mm | 10x | Ø28mm |
| 25x | Ø13mm | 5x | Ø32mm |

4822307 - TENSILE AND COMPRESSION SPRINGS ASSORTMENT, 200-PCS



- | | |
|-----------------------------|-------------------------|
| Compression springs: | Tensile springs: |
| 5.5 x 17.5mm | 4.0 x 79.5mm |
| 5.5 x 38.0mm | 4.5 x 44.5mm |
| 6.5 x 10.0mm | 5.0 x 20.5mm |
| 7.0 x 12.5mm | 5.5 x 25.5mm |
| 7.0 x 19.0mm | 6.5 x 22.0mm |
| 9.0 x 35.0mm | 7.0 x 51.0mm |
| 9.5 x 16.0mm | 7.0 x 38.0mm |
| 9.5 x 19.0mm | 8.0 x 28.5mm |
| | 8.0 x 31.5mm |
| | 8.0 x 44.5mm |
| | 8.5 x 36.5mm |
| | 8.5 x 47mm |

4822308 - PIN ASSORTMENT, 555-PCS



- 150x 1.6 x 25mm
- 75x 3.2 x 32mm
- 150x 2.5 x 25mm
- 50x 3.2 x 50mm
- 100x 2.4 x 38mm
- 30x 4.0 x 64mm

4822309 - CIRCLIP ASSORTMENT, 300-PCS



- | | | | |
|-----|-------|-----|-------|
| 20x | Ø3mm | 15x | Ø14mm |
| 10x | Ø4mm | 20x | Ø15mm |
| 15x | Ø5mm | 25x | Ø19mm |
| 25x | Ø6mm | 20x | Ø22mm |
| 15x | Ø8mm | 15x | Ø20mm |
| 20x | Ø9mm | 15x | Ø25mm |
| 15x | Ø11mm | 15x | Ø26mm |
| 15x | Ø12mm | 10x | Ø28mm |
| 25x | Ø13mm | 5x | Ø32mm |

4822310 - SEALING RING ASSORTMENT, 150-PCS



- | | | |
|------------------|--------------------|------------------|
| 1mm thick | 1.5mm thick | 2mm thick |
| 10x | 10x | 10x |
| 5 x 10mm | 10.5 x 17mm | 15 x 20mm |
| 6 x 10mm | 11 x 17mm | 16 x 22mm |
| 7 x 10mm | 12 x 10mm | 16.5 x 24mm |
| 8 x 12mm | 12.5 x 20mm | 17.5 x 24mm |
| 10 x 16mm | 14 x 18mm | 14 x 20mm |

4822311 - SYNCHRONISER RINGS ASSORTMENT, 1200-PCS

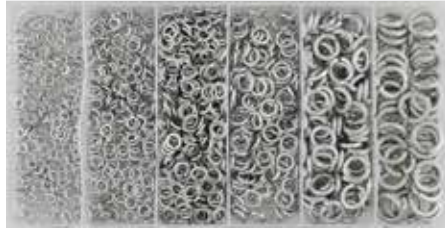

- | | | | | | |
|------|------|------|------|-----|-------|
| 300x | Ø3mm | 100x | Ø8mm | 50x | Ø10mm |
| | Ø4mm | | | | |
| | Ø5mm | | | | |
| 150x | Ø6mm | | | | |

4822312 - HOLLOW PIN/ASSORTMENT OF SYNCHRONISER RINGS, 450-PCS



- | | | | |
|------|---------|-----|----------|
| 150x | Ø2x20mm | 20x | Ø6x40mm |
| 80x | Ø3x30mm | 5x | Ø6x50mm |
| 30x | Ø3x40mm | 4x | Ø6x60mm |
| 40x | Ø4x30mm | 8x | Ø8x40mm |
| 20x | Ø4x40mm | 4x | Ø8x50mm |
| 30x | Ø4x50mm | 4x | Ø8x60mm |
| 4x | Ø7x70mm | 3x | Ø8x80mm |
| 30x | Ø5x40mm | 6x | Ø10x40mm |
| 5x | Ø5x50mm | 2x | Ø10x80mm |
| 5x | Ø5x60mm | | |

4822313 - HOSE CLAMP SET, 26-PCS



- 8x Ø16mm
- 2x Ø28mm
- 6x Ø22mm
- 2x Ø35mm
- 4x Ø25mm
- 4x Ø40mm

4822319 - BLIND RIVET ASSORTMENT, 400-PCS

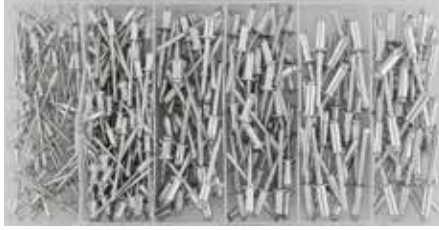

- 100x Ø2.4x37mm
- 100x Ø4.0x37mm
- 100x Ø3.2x37mm
- 100x Ø4.8x37mm

4822314 - NUT ASSORTMENT, 146-PCS



- 35x M4 X P0.7
- 25x M8 X P1.25
- 35x M5 X P0.8
- 16x M10 X P1.5
- 25x M6 X P1.0
- 10x M12 X P1.75

4822320 - GREASE NIPPLE ASSORTMENT, 110-PCS



- 60x M6 x P1.0
- 10x M8 x P1.25
- 10x M10 x P1.5
- 5x M6 x P1.0/45°
- 5x M8 x P1.25/45°
- 5x M10 x P1.5/45°
- 5x M6 x P1.0/90°
- 5x M8 x P1.25/90°
- 5x M10 x P1.5/90°

4822315 - BODY BOLTS AND SPEED NUT ASSORTMENT, 170-PCS



- | | |
|---------------------------|---------------------|
| Cross-slot Screws: | Speed Nuts: |
| 40x M3x8mm | 20x M3 |
| 20x M4x16mm | 20x M3 [with notch] |
| 15x M5x12mm | 20x M4 |
| 10x M6x20mm | 15x M5 |
| | 10x M6 |

4822321 - RUBBER GROMMET ASSORTMENT, 180-PCS



- 40x 1/4" [6.3mm]
- 20x 1/2" [12.5mm]
- 40x 5/16" [7.9mm]
- 5x 5/8" [15.9mm]
- 40x 3/8" [9.5mm]
- 5x 7/8" [22.2mm]
- 25x 7/16" [11.1mm]
- 5x 1" [25.4mm]

4822316 - CROCODILE CLIP ASSORTMENT, 28-PCS



- 10x 50mm (mini)
- 6x 65mm
- 6x 55mm
- 2x 70mm
- 2x 60mm
- 2x 80mm

4822322 - O-RING ASSORTMENT, 225-PCS



- | | |
|------------|-------------|
| 20x | 5x |
| Ø3 x 1mm | Ø9 x 2mm |
| Ø4 x 1mm | Ø10 x 2mm |
| Ø4.5 x 2mm | Ø12 x 3mm |
| Ø5 x 2mm | Ø13 x 3mm |
| Ø6 x 2mm | Ø14 x 2.5mm |
| Ø6 x 3mm | Ø17 x 2.5mm |
| Ø6 x 4mm | Ø18 x 4mm |
| Ø7 x 2mm | Ø20 x 2mm |
| Ø8 x 2mm | Ø22 x 2mm |

4822317 - AUTOMOTIVE FUSE ASSORTMENT, 121-PCS



- 20x 5A
- 20x 10A
- 20x 15A
- 20x 20A
- 20x 25A
- 20x 30A
- 1x Fuse removal tool

4822323 - O-RING ASSORTMENT, 419-PCS

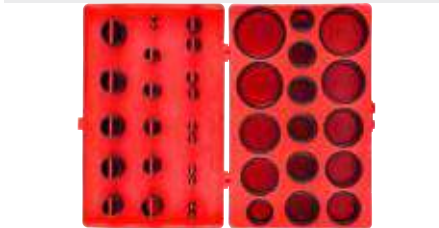

- | | | |
|-------------|---------------|---------------|
| Ø3 x 1.5mm | Ø18 x 3.5mm | Ø33 x 3.5mm |
| Ø4.4 x 2mm | Ø19 x 2.5mm | Ø34.5 x 3.5mm |
| Ø5 x 2mm | Ø20 x 3.5mm | Ø36 x 3.5mm |
| Ø7 x 1.5mm | Ø21 x 2.5mm | Ø38 x 3.5mm |
| Ø10 x 1.5mm | Ø22 x 2.5mm | Ø41 x 3.5mm |
| Ø10 x 2.5mm | Ø22 x 3.5mm | Ø44 x 3.5mm |
| Ø11 x 2.5mm | Ø23.5 x 3.5mm | Ø47 x 3.5mm |
| Ø13 x 1.5mm | Ø25 x 3.5mm | Ø50 x 3.5mm |
| Ø13 x 2.5mm | Ø26.5 x 3.5mm | |
| Ø14 x 2.5mm | Ø28 x 3.5mm | |
| Ø16 x 2.5mm | Ø30 x 3.5mm | |
| Ø18 x 2.5mm | Ø31 x 3.5mm | |

4822318 - QUICK-ACTION CONNECTOR ASSORTMENT, 50-PCS



- 25x Connectors for 0.5-1.5mm² cable cross-section
- 25x Connectors for 1.5-2.5mm² cable cross-section

4822324 - BOLT, NUT & WASHER ASSORTMENT, 240-PCS



- | | |
|---------------|----------------|
| 10x M4 x 12mm | 20x M4 x P0.7 |
| 10x M4 x 20mm | 20x M5 x P0.8 |
| 10x M5 x 16mm | 20x M6 x P1.0 |
| 10x M5 x 25mm | 10x M8 x P1.25 |
| 10x M6 x 20mm | 10x M10 x P1.5 |
| 10x M6 x 30mm | 20x Ø4 |
| 5x M8 x 25mm | 20x Ø5 |
| 5x M8 x 40mm | 20x Ø6 |
| 5x M10 x 40mm | 10x Ø8 |
| 5x M10 x 16mm | 10x Ø10 |

Sonic special tools

4822325 - MINI AUTO FUSE ASSORTMENT, 120-PCS



- 20x 5A
- 20x 10A
- 20x 15A
- 20x 20A
- 20x 25A
- 20x 30A

4822326 - AUTOMOTIVE FUSE ASSORTMENT, 120-PCS



- 20x 5A
- 20x 10A
- 20x 15A
- 20x 20A
- 20x 25A
- 20x 30A

4822327 - WASHER ASSORTMENT, 720-PCS

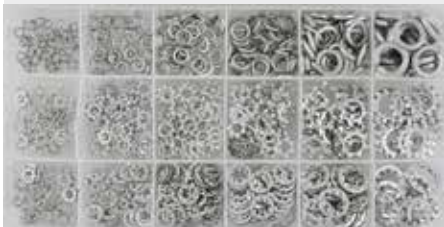

- 50x
 - #6 C-type, #6 star type, #6 Circle star type,
 - #8 C-type, #8 star type, #8 Circle star type,
 - #10 C-type, #10 star type, #10 Circle star type
- 40x
 - 6.4mm C-type, 6.4mm star type,
 - 6.4mm Circle star type
- 30x
 - 8.0mm C-type, 8.0mm star type,
 - 8.0mm Circle star type
- 20x
 - 9.5mm C-type, 9.5mm star type,
 - 9.5mm Circle star type

4822328 - CLEVIS PIN ASSORTMENT, 60-PCS



- | | |
|------------------|------------------|
| 3mm hole: | 4mm hole: |
| Ø5x25, Ø6x25mm | Ø10x25mm |
| Ø6x30, Ø6x40mm | Ø10x40mm |
| Ø6x45, Ø6x50mm | Ø10x50mm |
| Ø6x60, Ø6x65mm | Ø12x40mm |
| Ø8x25, Ø8x30mm | Ø12x50mm |
| Ø8x40, Ø8x45mm | |
| Ø8x50, Ø8x60mm | |
| Ø8x65, Ø8x70mm | |

4822329 - GLASS AUTO FUSE ASSORTMENT, 120-PCS



- 20x 5A
- 20x 10A
- 20x 15A
- 20x 20A
- 20x 25A
- 20x 30A

4822330 - ALUMINIUM WASHER ASSORTMENT, 300-PCS



- | | |
|---------------------|---------------------|
| Ø5 x Ø9 x 1.0mm | Ø16 x Ø20 x 1.5mm |
| Ø8 x Ø14 x 1.5mm | Ø20 x Ø24.5 x 0.8mm |
| Ø12 x Ø16 x 1.0mm | Ø24 x Ø32 x 2.0mm |
| Ø14 x Ø20 x 1.5mm | Ø8 x Ø12 x 1.0mm |
| Ø18 x Ø24 x 1.5mm | Ø10 x Ø14 x 1.5mm |
| Ø22 x Ø29 x 1.5mm | Ø13 x Ø18 x 1.0mm |
| Ø6 x Ø10 x 1.0mm | Ø16 x Ø22 x 1.5mm |
| Ø9 x Ø14 x 1.0mm | Ø19 x Ø26 x 2.0mm |
| Ø12 x Ø16 x 1.5mm | Ø26 x Ø34 x 2.0mm |
| Ø14 x Ø20 x 2.0mm | Ø8 x Ø14 x 1.0mm |
| Ø20 x Ø24.5 x 1.5mm | Ø10 x Ø16 x 1.0mm |
| Ø24 x Ø29 x 1.5mm | Ø14 x Ø18 x 1.5mm |
| Ø6 x Ø12 x 1.0mm | Ø18 x Ø22 x 1.5mm |
| Ø10 x Ø14 x 1.0mm | Ø22 x Ø27 x 1.0mm |
| Ø12 x Ø18 x 1.5mm | Ø28 x Ø36 x 2.0mm |

4822333 - INSULATED CRIMP TERMINAL ASSORTMENT, 160-PCS



- 4x RV 5.5-5 & 5.5-8 & 5.5-10 Yellow
- 5x MDD 5.5-250 & FDD 5.5-250 Yellow
- 12x BV 5.5-5 Yellow
- 10x RV 2-4L & 2-SL & 2-6 Blue
- 10x MDD 2-250 & FDD 2-250 Blue
- 10x MBB 2 & FBB 2 Blue
- 10x SVL 2-4 Blue
- 4x Scotchlok Blue
- 12x BV 2 Blue
- 8x RVS 1.25-4 Red
- 4x Scotchlok Red
- 18x BV 1.25 Red

4822334 - MASTER PLUG-IN STYLE FUSE ASSORTMENT, 118-PCS



- | | | |
|--------------|---------------|-------------|
| 3x maxi 20A, | 5x mini 2A | 5x ATO 3A |
| 3x maxi 30A, | 5x mini 3A | 5x ATO 5A |
| 3x maxi 40A, | 5x mini 4A | 5x ATO 7.5A |
| 3x maxi 50A, | 5x mini 5A, | 5x ATO 10A |
| 3x maxi 60A, | 5x mini 7.5A, | 5x ATO 15A |
| 3x maxi 80A, | 5x mini 10A, | 10x ATO 20A |
| | 5x mini 15A, | 5x ATO 25A |
| | 5x mini 20A, | 5x ATO 30A |
| | 5x mini | |
| | 5x mini 30A | |

4822335 - AUTO FUSE ASSORTMENT, 80-PCS



- 10x 3A
- 10x 5A
- 10x 7.5A
- 10x 10A
- 10x 15A
- 10x 20A
- 10x 25A
- 10x 30A

4822336 - MINI AUTO FUSE ASSORTMENT, 75-PCS



- 10x 2A
- 5x 3A
- 5x 4A
- 10x 5A
- 5x 7.5A
- 10x 10A
- 10x 15A
- 10x 20A
- 5x 25A
- 5x 30A

4822337 - DRAIN PLUG GASKET ASSORTMENT, 60-PCS



- 10x 1/2" fiber
- 10x 1/2" fiber
- 10x 1/2" nylon
- 10x 14mm nylon
- 5x 12mm nylon
- 5x 14mm fiber
- 5x 18mm fiber
- 5x 20mm fiber

4822338 - GLASS AUTO FUSE ASSORTMENT, 95-PCS



- 5x 5A
- 10x 10A
- 20x 15A
- 20x 20A
- 20x 25A
- 20x 30A

4822339 - BUTT CONNECTOR ASSORTMENT, 100-PCS

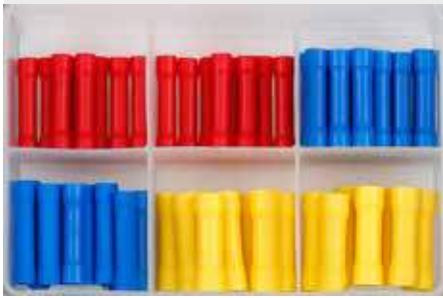

- 10x 22-18
- 10x 22-18
- 30x 16-14
- 30x 16-14
- 10x 12-10
- 10x 12-10

4822340 - SHRINK TUBE ASSORTMENT, 85-PCS



- 20x 1/8"
- 15x 1/4"
- 20x 3/16"
- 10x 3/8"
- 15x 1/4"
- 5x 1/2"

4822341 - BUTT CONNECTOR ASSORTMENT WITH SHRINK, TUBE 60-PCS

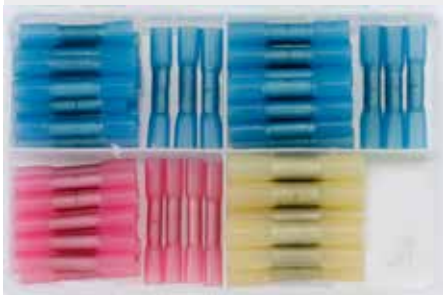

- 8x 22-18
- 7x 22-18
- 15x 16-14
- 15x 16-14
- 8x 12-10
- 7x 12-10

4822342 - TRIM CLIP ASSORTMENT FOR NISSAN, 408-PCS



- 10x
- 20x
- 10x
- 18x
- 25x
- 10x
- 50x
- 15x
- 25x
- 15x
- 5x
- 30x
- 20x
- 5x
- 15x
- 65x
- 20x
- 50x

4822343 - TRIM CLIP ASSORTMENT FOR MAZDA, 475-PCS



- 25x
- 15x
- 15x
- 25x
- 20x
- 50x
- 20x
- 55x
- 50x
- 30x
- 15x
- 5x
- 20x
- 20x
- 20x
- 20x
- 30x
- 55x

4822344 - TRIM CLIP ASSORTMENT FOR MITSUBISHI, 370-PCS



- 10x
- 40x
- 15x
- 30x
- 50x
- 15x
- 10x
- 40x
- 10x
- 15x
- 20x
- 20x
- 50x
- 15x
- 20x
- 40x
- 10x
- 5x

4822345 - TRIM CLIP ASSORTMENT FOR FORD, 415-PCS

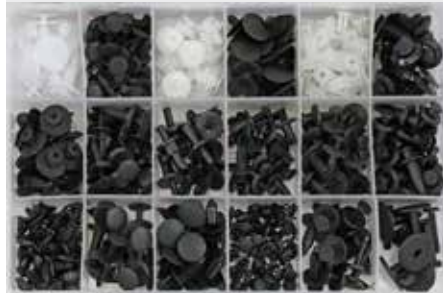

- 10x
- 40x
- 15x
- 30x
- 50x
- 15x
- 10x
- 40x
- 10x
- 15x
- 20x
- 20x
- 50x
- 15x
- 20x
- 40x
- 10x
- 5x

4822346 - TRIM CLIP ASSORTMENT FOR VOLKSWAGEN, 255-PCS



- 30x
- 35x
- 30x
- 25x
- 25x
- 5x
- 30x
- 25x
- 5x
- 15x
- 10x
- 20x

4822347 - PLASTIC LOCKING NUT ASSORTMENT, 350-PCS



- 20x
- 40x
- 30x
- 30x
- 25x
- 30x
- 30x
- 30x
- 20x
- 40x
- 30x
- 25x

4822348 - TRIM CLIP ASSORTMENT FOR TOYOTA/LEXUS, 360-PCS



- 10x
- 25x
- 20x
- 35x
- 30x
- 15x
- 15x
- 40x
- 10x
- 20x
- 10x
- 20x
- 25x
- 25x
- 15x
- 20x
- 10x
- 15x

Sonic special tools

4822349 - TRIM CLIP ASSORTMENT FOR RENAULT, 300-PCS



4822353 - TRIM CLIP ASSORTMENT FOR VOLVO, 350-PCS

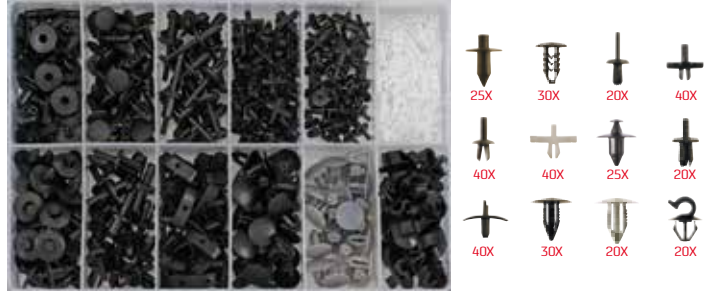

4822350 - TRIM CLIP ASSORTMENT FOR VAUXHALL/ OPEL 300-PCS

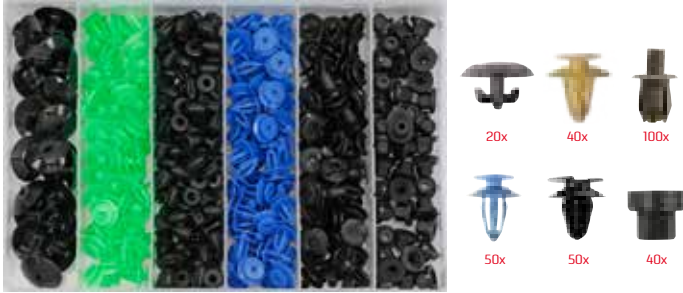

4822354 - TRIM CLIP ASSORTMENT FOR BMW, 290-PCS



4822351 - TRIM CLIP ASSORTMENT FOR PEUGEOT, 345-PCS



4822355 - TRIM CLIP ASSORTMENT FOR MERCEDES BENZ, 270-PCS



4822352 - TRIM CLIP ASSORTMENT FOR FIAT, 308-PCS



4822356 - TRIM CLIP ASSORTMENT FOR AUDI, 160-PCS



07

110001 - SPRING COMPRESSOR, 1800KG



Apart from being competitively priced, Sonic spring compressor is one of the most user-friendly coil spring compressors on the market, making dismantling of McPherson struts safer, easier and much faster compared to using a traditional tool. Sonic spring compressor is supplied with two sets of standard jaws which work efficiently with the springs on approximately 90% of all cars.



- Handles approximately 90% of all cars
- High quality coil spring compressor used by thousands of professionals
- Supplied with two sets of standard jaws
- Built-in protective accessory
- Large user-friendly adjusting handle
- TÜV approved safety



INNOVATIVE BUILT-IN PROTECTIVE ACCESSORY	ERGONOMIC HANDLES	TWO PAIRS OF STANDARD JAWS EASILY CHANGED	AIR WRENCH	SPECIFICATIONS	ACCESSORIES
<ul style="list-style-type: none"> - For safe and easy clamping in the bench vice - Made from high-tech hard-wearing polyurethane 	<ul style="list-style-type: none"> - Large user-friendly and ergonomic adjusting handle - For easier and faster manual positioning of the jaws - Ergonomic handle on the body makes the tool more comfortable to hold 	<ul style="list-style-type: none"> - Jaws secured with strong bolts - Equipped with a lip which locks the spring during compression improving safety - Powder coated surface to protect the springs 	<ul style="list-style-type: none"> - Can be used on the spindle - To avoid overload use max. 180Nm air wrench 	<ul style="list-style-type: none"> - Max load 1800 kg - Two sets of jaws: 2 pieces ø80-120mm and 2 pieces ø80-200mm - Built-in safety pin - Use air wrench max 180Nm - Maximum distance: 364mm - Minimum distance: 80mm - Weight body: 5.2kg - Weight included jaws: 10.7kg 	<p>Jaws for special springs are available on request</p>

871192 - SPRING COMPRESSOR WITH EXTRA BRACKET 1800KG



Sonic special tools

120001 - SPRING COMPRESSOR, 1500KG



Apart from being competitively priced and makes the dismantling of mcpherson struts both safer and easier. It is very simple and easy to use the Sonic spring compressor and compared with using a traditional tool, makes the operation much faster giving a considerable saving in working hours. Sonic spring compressor is supplied with two sets of standard jaws which work efficiently with the springs on approximately 90% of all cars.



STRUT

07



AIR WRENCH

JAWS

- Handles approximately 90% of all cars
- High quality coil spring compressor used by thousands of professionals
- Supplied with two sets of standard jaws
- Supplied with safety wire
- Tailored protective jaws for clamping the bench vice are additional accessories
- TÜV approved safety



INNOVATIVE BUILT-IN PROTECTIVE ACCESSORY	TWO PAIRS OF STANDARD JAWS EASILY CHANGED	AIR WRENCH	SPECIFICATIONS	ACCESSORIES
<ul style="list-style-type: none"> - For safe and easy clamping in the bench vice - Made from high-tech hardwearing polyurethane 	<ul style="list-style-type: none"> - Jaws secured with strong bolts - Equipped with a lip which locks the spring during compression improving safety - Powder coated surface to protect the springs 	<ul style="list-style-type: none"> - Can be used on the spindle - To avoid overload use max. 180Nm air wrench 	<ul style="list-style-type: none"> - Max load 1500kg - Two sets of jaws: 2 pieces ø80-145mm and 2 pieces ø145-195mm - Built-in safety pin - Use air wrench max 180Nm - Maximum distance: 354mm - Minimum distance: 80mm - Weight body: 4.7kg - Weight included jaws: 10.2kg 	<p>Jaws for special springs are available on request.</p>



SPRING

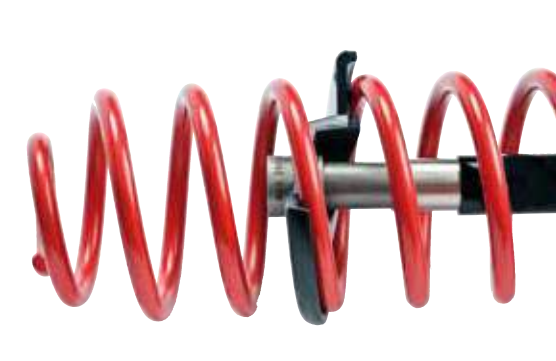

JAW IN SPRING

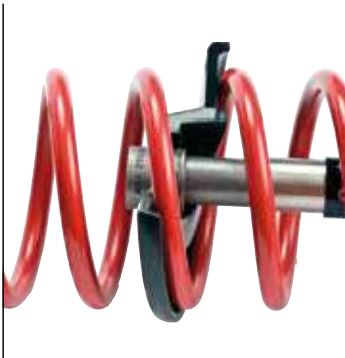

07

- Handles 95% of all cars with wishbone/multilink suspension rear and front
- Only tool on the market capable of handling among others VW Touran, Citroën C3, Skoda Octavia, and Peugeot 107
- Very compact design makes it possible to use the tool for cars with a small hole in the rear spring control arm down to Ø30 mm
- Unique safety key torque
- Only on the market with angled jaws
- Patent pending
- TÜV approved safety



INNOVATIVE ANGLED SHAPE OF THE JAWS	UNIQUE SAFETY KEY TORQUE	TWO PAIRS OF STANDARD JAWS EASILY CHANGED	SPECIFICATIONS	ACCESSORIES
<ul style="list-style-type: none"> - Only universal spring compressor on the market for wishbone/ multilink suspension with angled jaws - Improves safety - Provides a high degree of functionality 	<ul style="list-style-type: none"> - Only universal spring compressor on the market for wishbone/ multilink suspension with angled jaws - Improves safety - Provides a high degree of functionality 	<ul style="list-style-type: none"> - Functions as extension unit - Makes it easier, safer and more convenient to position the tool correctly inside the spring - Prevents overload - Improves safety 	<ul style="list-style-type: none"> - Max load 1500kg - Two sets of jaws: 2 small angled jaws ø90-120mm and 2 large angled jaws ø120-140mm for Mercedes and many other cars with wishbone/multilink suspension - Use air wrench - Maximum distance: 167mm - Minimum distance: 70mm - Weight body: 1.65kg - Weight include jaws: 2.5kg 	<ul style="list-style-type: none"> - Large angled and large flat jaws are available on request



07

**WORK
EFFICIENT
WORK
WITH SONIC**



**SONIC
JACKS**

Always aim for greater heights.

Sonic special tools

Aluminum jacks in an extra low version. The jacks are equipped with nylon wheels (2 swivel wheels) and a two-part control rod and a carrying handle. The jacks come with a pick-up dish with a rubber pad.

GG0

48032 - ALUMINUM JACK, 2 TON

- Maximum lifting capacity: 2000kg
- Minimum lift height: 83mm
- Maximum lift height: 470mm
- Total length: 632mm
- Diameter pick-up dish: 108mm

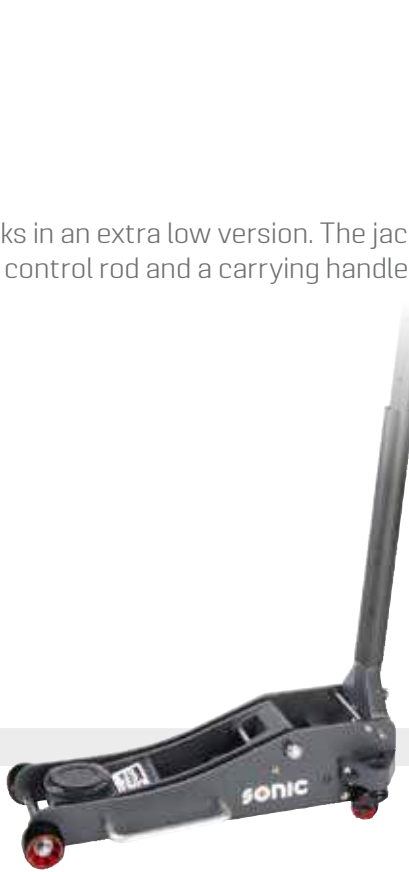

GG0

48031 - ALUMINUM JACK, 1,5 TON

- Maximum lifting capacity: 1500kg
- Minimum lift height: 88mm
- Maximum lift height: 360mm
- Total length: 484mm
- Diameter pick-up dish: 108mm



Steel jacks in an extra low version and therefore very suitable for light commercial vehicles. The jacks are equipped with nylon wheels (2 swivel wheels) and an extra foot control. Furthermore, the jacks have a two-part operating rod with handle and a protective foam cover. The jacks come with a pick-up dish with a rubber pad and an extra shell for small material.



GG0

48034 - LOW PROFILE JACK, 3 TON

- Maximum lifting capacity: 3000kg
- Minimum lift height: 75mm
- Maximum lift height: 505mm
- Total length: 673mm
- Diameter pick-up dish: 108mm



GG0

48035 - LOW PROFILE JACK, 1,5 TON, EXTRA LONG

- Maximum lifting capacity: 1500kg
- Minimum lift height: 70mm
- Maximum lift height: 610mm
- Total length: 863mm
- Diameter pick-up dish: 108mm



GG0

48033 - LOW PROFILE JACK, 2 TON

- Maximum lifting capacity: 2000kg
- Minimum lift height: 75mm
- Maximum lift height: 505mm
- Total length: 675mm
- Diameter pick-up dish: 108mm



4822331 - FOLDABLE ENGINE CRANE, 1 TON



DESCRIPTION	SPECIFICATIONS
-------------	----------------

Constructed from heavy gauge, welded square tubular steel. The 2 speed hydraulic pump with chromed ram rotates up to 135 degrees ensuring the optimal working position. Fine adjustment lowering handle with dead man's control prevents from rapid uncontrolled lowering of load. Nylon casters avoid floor damage. The arm has 3 pre-set positions for lifting. Easy to maneuver in open or closed position due to unique supporting wheels at the front of the base plate.

Measurements folded:
L 1499 x W 90 x H 1405mm

POSITION	CAPACITY	MINIMUM HEIGHT	MAXIMUM HEIGHT
1	1000KG	334mm	2120mm
2	750KG	214mm	2210mm
3	500KG	94mm	2300mm



4800708 - TRANSMISSION JACK, 500KG

Professional transmission jack, for mounting and dismounting gearboxes and transfer boxes. This 500kg version has nylon swivel wheels for easy maneuvering. The jack is equipped with a quick-lift foot control. Due to the reversible pick-up head, the jack is multifunctional.



4800707 - JACK STANDS, 3 TON

Jack stands with a capacity of 3 ton for the safe support of various vehicles and other heavy objects.
- Min. height 305mm
- Max. height 450mm



48025 - SCISSOR JACK

- Maximum capacity: 1 ton
- Minimum height: 90mm
- Maximum height 330mm

Compact hydraulic bottle jacks for lifting different types of vehicles and other heavy objects.



4800701 - BOTTLE JACK 2 TON

- Lifting capacity 2 ton
- Min. lift height 158mm
- Max. lift height 308mm



4800702 - BOTTLE JACK 4 TON

- Lifting capacity 4 ton
- Min. lift height 180mm
- Max. lift height 350mm



4800703 - BOTTLE JACK 6 TON

- Lifting capacity 6 ton
- Min. lift height 197mm
- Max. lift height 382mm



4800704 - BOTTLE JACK 8 TON

- Lifting capacity 8 ton
- Min. lift height 205mm
- Max. lift height 390mm



4800705 - BOTTLE JACK 12 TON

- Lifting capacity 12 ton
- Min. lift height 218mm
- Max. lift height 400mm



4800706 - BOTTLE JACK 20 TON

- Lifting capacity 20 ton
- Min. lift height 244mm
- Max. lift height 449mm





SONIC REELS

Say goodbye to knotted cables
and messy hoses.

4822401 - CABLE REEL 18 METER

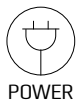

SPECIFICATIONS

- Automatic rewinding spring
- Plastic outer casing
- Steel swiveling wall bracket
- Ratched stop device easily inspectable and removable by the end user
- 3 X 1,5mm² cable
- With coiled cable a maximum capacity of 800w
- With unrolled cable a maximum capacity of 200w
- CE approved
- TÜV approved

4822402 - AIR HOSE REEL 9 MTR, Ø8MM, MAX. 10 BAR



SPECIFICATIONS

- Automatic rewinding spring- Plastic outer casing
- Steel swiveling wall bracket
- Ratched stop device easily inspectable and removable by the end user
- Fitting 1/4"
- Hose diameter 8mm
- Maximum working pressure 10 bar
- Glossy polyurethan hose
- CE approved

4822403 - AIR HOSE REEL 12 MTR, Ø8MM, MAX. 15 BAR



SPECIFICATIONS

- Automatic rewinding spring
- Plastic outer casing
- Steel swiveling wall bracket
- Ratched stop device easily inspectable and removable by the end user
- Fitting 1/4"
- Hose diameter 8mm
- Maximum working pressure 15 bar
- Glossy polyurethan hose
- CE approved

4822404 - AIR HOSE REEL 8 MTR, Ø10MM, MAX. 15 BAR



SPECIFICATIONS

- Automatic rewinding spring
- Plastic outer casing
- Steel swiveling wall bracket
- Ratched stop device easily inspectable and removable by the end user
- Fitting 3/8"
- Hose diameter 10mm
- Maximum working pressure 15 bar
- Glossy polyurethan hose
- CE approved

4822405 - AIR HOSE REEL 15 MTR, Ø8MM, MAX. 15 BAR



SPECIFICATIONS

- Automatic rewinding spring
- Plastic outer casing
- Steel swiveling wall bracket
- Ratched stop device easily inspectable and removable by the end user
- Fitting 1/4"
- Hose diameter 8mm
- Maximum working pressure 15 bar
- Glossy polyurethan hose
- CE approved

4822406 - AIR HOSE REEL 14+1 MTR, Ø10MM, MAX. 15 BAR



SPECIFICATIONS

- Automatic rewinding spring
- Plastic outer casing
- Steel swiveling wall bracket
- Ratched stop device easily inspectable and removable by the end user
- Fitting 3/8"
- Hose diameter 10mm
- Maximum working pressure 15 bar
- Glossy polyurethan hose
- CE approved

4822411 - CABLE REEL WITH CHARGING CABLES 6 METER

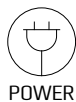

SPECIFICATIONS

- Automatic spring rewinding
- Plastic outer casing
- Steel swivelling wall bracket
- Ratched stop device easily inspectable and removable by the end user
- Hose diameter 16mm
- 30A
- Ratched stop device easily inspectable and removable by the end user
- CE approv



SLOW MOTION SYSTEM:

This system makes it possible to slowly and uniformly wind cables and hoses without jerking or whiplash. It guarantees increased safety, better organization and higher productivity in the workplace. Zero damage to property and no personal injuries. This system is available and applicable for all cable- and air hose reels, also after installation and can be mount easily on the outside of the housing.

ART. NO.	MIN-MAX HEIGHT
4822407	Slow motion system for reel 4822401
4822408	Slow motion system for reel 4822402
4822409	Slow motion system for reel 4822405
4822410	Slow motion system for reel 4822403



Power Lights



***SONIC
LIGHTS***

Designed for convenience &
optimal lighting.

4820519 - 3-IN-1 SLIM LIGHT (MINI)



07

GENERAL INFORMATION

- COB LED/spot: high power LED
- Work light: 100/200 lumen
- Spot light: 100 lumen
- Light intensity work light: 150/400 lux at 0.5m
- Light intensity spot light: 5200 lux at 0.5m
- Operating time: work light 5 hours, spot light 2.5 hours
- Charging time: 3 hours
- 3.7V/1200 mAh li-ion battery
- Protection IP30

4820520 - 3-IN-1 SLIM LIGHT



GENERAL INFORMATION

- COB LED/spot: high power LED
- Work light: 250/500 lumen
- Spot light: 100 lumen
- Light intensity work light: 400/800 lux at 0.5m
- Light intensity spot light: 4800 lux at 0.5m
- Operating time: work light 2.5 hours, spot light 5 hours
- Charging time: 4.5 hours
- 3.8V/2800 mAh li-ion battery
- Protection IP30

4820516 - POCKET-SIZED, ULTRA-SLIM WORK LIGHT WITH TOP FLASH LIGHT



4820517 - WORK LAMP WITH TOP FLASH LIGHT



07



GENERAL INFORMATION

- COB LED
- 1600 mAh li-ion rechargeable high capacity battery
- Charge indicator
- 180° angle stand with magnet
- Swivel hook
- Setting 1: 100 lumen, setting 2: 125 lumen
- Spot light: 75 lumen
- Light intensity setting 1: 130 lux at 0.5m
- Light intensity setting 2: 260 lux at 0.5m
- Operating time setting 1: 6 hours, setting 2: 3 Hours
- Operating time spot light: 4 hours
- Charging time: 2.5 hours
- Including 220V charger
- Including usb charger
- Weight: 112g
- Protection IP65

GENERAL INFORMATION

- COB LED/high power
- 1600 mAh li-ion rechargeable high capacity battery
- Charge indicator
- 180° angle stand with magnet
- Swivel hook
- Work light: 250 lumen
- Spot light: 120 lumen
- Light intensity setting 1: 100 lux at 0.5m
- Light intensity setting 2: 340 lux at 0.5m
- Operating time work light: 3 hours
- Operating time spot light: 3 hours
- Charging time: 3 hours
- Including 220V charger
- Including usb charger
- Weight: 160g
- Protection IP65

4820515 - MULTIFUNCTIONAL INSPECTION WORK LIGHT



4820518 - HEADLAMP



07

GENERAL INFORMATION

- Work light with 3 magnets
- Lamp head tilts up to 180°
- Two adjustable and retractable suspension hooks
- 2200 mAh li-ion rechargeable high capacity battery
- 7X SMD LED (main light)
- High power LED spot light
- Setting 1: 50 lumen, setting 2: 300 lumen
- Spot light: 100 lumen
- Light intensity setting 1: 250 lux at 0.5m
- Light intensity setting 2: 5000 lux at 0.5m
- Light intensity spot light: 800 lux at 0.5m
- Operating time setting 1: 5 hours, setting 2: 2.5 Hours
- Operating time spot light: 4 hours
- Charging time: 4 hours
- Including 220V charger
- Including usb charger
- Weight: 266g
- Protection IP20

GENERAL INFORMATION

- Lights up your entire field of view
- New rechargeable battery technology
- Designed for professional work
- Sensor function
- 1600 mAh li-ion rechargeable high capacity battery
- 2W COB LED
- Setting 1: 125 lumen, setting 2: 250 lumen
- Light intensity setting 1: 300 lux at 0.5m, setting 2: 500 lux at 0.5m
- Operating time: setting 1: 6 hours; setting 2: 3 hours
- Charging time: 4 hours
- Weight: 140g
- Protection IP65



- COB LED
- 0-400 LUMEN (ADJUSTABLE LUMEN SWITCH)
- 2200MAH
- 3-4H FULL LIGHT
15H SEMI LIGHT
- 2-3H
- 20°C | +50°C
- IP54
- 375X35MM
- 175G

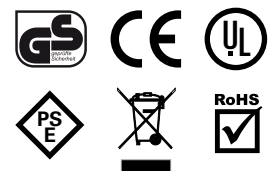

GENERAL INFORMATION

- Unique variable dial lets you control the output (max 400 Lumen)
- Adjustable magnetic swivel base lets you control the desired angle
- Folding loop or magnetic swivel base to mount in desired work location

07

4821106 - NOVA COB LED LIGHT 30W



GENERAL INFORMATION

This light is a universal all-around work light both rechargeable and with cable (dual system) providing you endless application possibilities in every working environment. The new light dimmer function makes it possible to adjust the light into five different levels.

- Operating time: 1-14 hours
- Charging time: 2 hours
- 5 settings light output; 300-2250 lumen
- Light intensity: 5000 lut at 0,5m
- Cable: 5m / 2x0,75mm²
- Battery: 11.1V / 4400 mAh li-ion
- Operating temperature: -10 to +40°C
- Weight: 1,78kg

4821102 - LIGHT AND TORCH 21+5 LED



2X ADJUSTABLE SUSPENSION HOOKS

SPOTLIGHT 5 LEDS

3 BUILT-IN MAGNETS



GENERAL INFORMATION

- Operating time: main light up to 4 hours
- Operating time: spot light up to 15 hours
- Charging time: 4 hours
- Main light with 21 high bright LED
- Spot light with 5 high bright LED
- Battery charger 230V AC/50hz
- 3,7V/1200 mAh li-ion rechargeable battery
- LED intensity: main light 800 lux at 0,5m
- LED intensity: spot light 300 lux at 0,5m
- Operating temperature -10 to +40°C
- Protection IP20
- Weight 0,30kg

4821105 - EXTREMELY POWERFUL FLASH PEN 1W LED



GENERAL INFORMATION

- Light intensity: 1100 lux
- Operating time: up to 8 hours
- Light beam up to 75m
- Battery 2x aaa included
- Weight: 150g
- Protection IP54
- Delivered in a gift box

4820513 - INSPECTIONS WORK LIGHT 8W



GENERAL INFORMATION

- Nominal voltage 230V ~ 50-60hz
- Main cable 5m, 2x0,75mm²
- Electronic ballast in handle

07



**WORK
EFFICIENT
WORK
WITH SONIC**



SONIC BOOSTERS

Designed for intensive
& professional use.

 Made in Belgium

Boosters



Sonic Booster
START ENGINE USE SONIC BOOSTER

The Sonic booster range offers professional and reliable solutions for all users. In terms of power, our range starts where other competitors end theirs. Our least powerful batteries deliver more power than most average batteries of competing products. Don't be misled by booster and battery ratings! When it comes to jump starting vehicles, what really matters is the power in Cranking Amps (CA), not in Peak Amps (PA). In addition to powerful AGM batteries, our boosters are all equipped with high-quality components which are also very important: double-insulated starting cables, fully insulated clamps with curved and bronze jaws, resistant Anderson connectors, etc. The Sonic boosters are professional tools designed for professional and intensive use.



CABLES: Sonic starting cables are double insulated, extra-long, extremely flexible and of very high conductivity. Cables of other boosters are tiny and that's why they make knots inside and break.

CASE: The single-piece moulded case in polyethylene of 5mm, unbreakable and with a lifetime warranty assures excellent resistance to shocks and intensive uses. Cases of other boosters are slim and made out of 2 parts. So it's fragile and more difficult to handle when you have to repair.

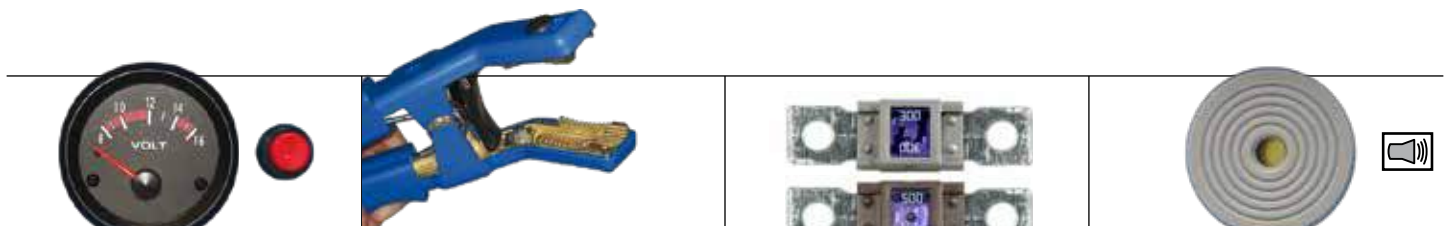

VOLTMETER: The Sonic booster uses a traditional voltmeter with a needle where other competing products use LED lights to show the charging level. The voltmeter indicates the precise charging level and can be used to test the proper functioning of the alternator of the vehicle. The battery of a booster must reach 13V when it's recharged and when it's connected to the car-battery. The engine must reach 14,4V because that's the power your car alternator must produce.

CLAMPS: The massive clamps of the Sonic booster are fully insulated and ergonomic with big opening and a braided copper strap in order to spread current through both jaws. Clamps from other boosters are less user-friendly and don't deliver full current through both jaws. They are also less robust.

FUSES: The internal fuse protects the batteries against short-circuits and overcharge (overuse).

BUZZER: A buzzer that produces a tone will inform you of an inversion of polarity, in option for the 12V Sonic models.



- Read manual first
- Charge the Sonic booster completely before use
- To ensure long life and optimize the use of the Sonic booster battery, you must put the Sonic booster on continuous charge after each use using the automatic provided charger
- When not using the Sonic booster for long period of time, recharge the unit (using the original automatic electric 230V AC charger) every 3 months for at least 48hrs
- When using the Sonic booster to start an engine, do not cranc for more than 8-10 seconds, and wait for a futher 3 minutes before a second attempt
- Never completely discharge the Sonic booster battery
- Never recharge the Sonic booster using a 24V recharging (cigarette lighter) plug on board of a vehicle



48132 - BOOSTER PORTABLE MINI 12V/440CA



SPECIFICATIONS

- Voltage 12V
- Cranking amps 440A
- Peak amps 1600A
- Cable length 60cm
- Cable size 25mm²
- Adaptor AC/DC 1.3A
- Fuse on battery 300A
- Weight 6,5kg
- Dimensions cm (LxWxH) 36 x 13 x 24 cm

48150 - 12V/800CA



SPECIFICATIONS

- High rate AGM battery
- Cranking Amps: 800CA
- Cables: pure copper, double insulation 155cm/25mm²
- Heavy duty clamps
- Battery charger: automatic 12V 1.3A
- Analog voltmeter
- 12V DC socket (input & output)
- 300A short circuit protection fuse
- Rotomolded plastic housing unbreakable
- Weight: 9,5kg
- Dimensions: 375 x 110 x 320mm

48108 - 12V/1200CA



SPECIFICATIONS

- Gasoline or diesel, utility, 4x4, second-hand and agricultural service to start diesel engines up to 350HP as booster
- 250HP as substitute battery

48151 - 12V/24V 1600/800CA



SPECIFICATIONS

- AGM batteries with high capacity (2)
- Starting current: 1600/800CA
- Cables: pure copper, double insulation 135cm/35mm²
- Battery charger: automatic 12V 4A
- Analog voltmeter
- 12V DC socket (output only)
- Anderson connectors for voltage selection (12/24V)
- Reverse polarity alarm
- 300A fuse against short circuit
- Heavy 45° curved clamps with LED light in blue clamp
- Rotational molded plastic housing (unbreakable)
- Weight: 20,5kg
- Dimensions: 530 x 160 x 480mm

48109 - 12/24V-2400/1200CA



SPECIFICATIONS

Gasoline or diesel, light truck, agricultural service, heavy truck, bus, tank, plane, boat, etc. Perfect for starting engines up to 1500HP which have been stationary for a long time, in extreme temperature conditions from -30° to +60°C, without batteries. Practical example: capable to start a 1500HP 38 litres, Mercedes Leopard tank without batteries

48110 - 12/24V-3200/1600CA



SPECIFICATIONS

Gasoline or diesel, light truck, agricultural service, heavy truck, bus, tank, plane, boat, etc. Flexible 12V or 24V for extreme use, 25% more power than the 12/24V-2400/1200CA unit. Perfect for starting engines up to 1500HP which have been stationary for a long time, in extreme temperature conditions from -30° to +60°C, without batteries.

48111 - 12/24V-1600/800CA



SPECIFICATIONS

- Gasoline or diesel, utility, 4x4, second-hand and agricultural service, heavy truck to start diesel engines in 24V up to:
- 500HP as booster
- 250HP as substitute battery

48149 - GIGA LITHIUM 12V/800CA

48152 - DOCKINGSTATION FOR 48149



SPECIFICATIONS

- Battery: Lithium LiFePO4 (4 cells)
- Cranking Amps: 800CA
- Cables: pure copper, 50cm/10mm²
- Battery charger: automatic 12V 1.3A
- Digital display with LED indicators
- Full protection against reverse polarity, short circuits, overvoltage, overcharge, overtemperature, overdischarge
- Equipped with a memory saver function
- Heavy duty clamps
- Weight: 2,5kg
- Dimensions: 260 x 135 x 72mm

For whom performance really counts



POWER: outcome from the aero space technology, the batteries in the Sonic Booster (AGM/MF, pure lead, made in USA) have an extraordinary energy storage and delivery at very high currents.

ELECTRONIC PROTECTION: the Sonic booster is no danger for the electronic equipment of the vehicles. These jump starters have done millions of startings without any damage (Certificate of AXA insurance policy - NO file has been opened in more than 20 years).

LIABILITY: all the components of the Sonic booster have been selected worldwide for their very high quality for an intensive use dedicated for professionals:

The moulded single-piece polyethylene body of 5 mm, unbreakable (life time warranty), assures excellent resistance to the shocks and everyday uses. Does not take much space in a recovery service vehicle and its ergonomic shape facilitates its use and storage.

The Radaflex® starting cables (double isolation) extra-long, are extremely flexible and of very high conductivity. They allow the user to leave the booster on the ground while starting the vehicle. The electronic automatic charger with continuous current, manages and maintains the battery in perfect condition in order to give full power at start. The recharging cord through cigarette-lighter (DC/DC) allows a quick recharge on board of a 12V vehicle.



Warranty
All users benefit from a one-year warranty on components and workmanship.



MODEL	BOOSTER MINI 12V/440CA	MICRO 12V/1200CA	SONIC 12/24V 1600/800CA	SONIC 12/24V 2400/1200CA	SONIC 12/24V 3200/1600CA	SONIC 12/24V 800A	SONIC 12V 800A	SONIC 12V 1600/800A
Sonic item	48132	48108	48111	48109	48110	48149	48150	48151
Voltage (DC Volts)	12V	12V	12/24V	12/24V	12/24V	12V	12V	12V
Cranking amps	440 A	1200 A	1600/800 A	2400/1200 A	3200/1600 A	800 A	800 A	1600/800 A
Peak amps	1600 A	3100 A	4740/2370 A	6200/3100 A	7750/3875 A	4000 A	2370 A	4740/2370 A
Number of batteries	1	1	2	2	2	1	1	2
Cable length	0,6 m	1,50 m	1,35 m	1,35 m	1,95 m	0,5m	1,55m	1,35m
Radaflex welding cable size	25 mm ²	35 mm ²	50 mm ²	50 mm ²	70 mm ²	10 mm ²	25 mm ²	50 mm ²
Type of clamps	F600	850 A	850 A	850 A	850 A	850A	850A	850A
Auto. electr. charger AC/DC	1,3 A	2 A	4 A	4 A	7 A	1,3 A	1,3 A	4 A
Power adapter cord DC/12V	yes	yes	upon request	upon request	upon request	yes	Yes	yes
12V output	16A	16A	16A	16A	16A	16A	16A	16A
Reverse polarity system	option	option	yes	yes	yes	yes	yes	yes
Fused protection	yes	yes	yes	yes	yes	yes	yes	yes
Weight	6,5kg	14,5kg	21,5kg	24,8kg	55kg	2,5kg	11,5kg	23kg
Shipping weight	8,5kg	16,5kg	23kg	27kg	59,5kg	4,5kg	13,5kg	25kg
Dimensions (mm)	360x130x240mm	450x247x390mm	530x160x480mm	530x160x480mm	470x340x970mm	300x230x60mm	430x350x110mm	520x500x140mm



48112...



ART. NO.	DESCRIPTION
4811205	Triple wrap cable Sonic micro (1,9m instead of 1,3m)
4811206	Triple wrap cable Sonic portable 12V (2,4m instead of 1,5m)
4811207	Double wrap cable Sonic portable 12/24 & 24V (2,3m instead of 1,35m)

4811208



ART. NO.	DESCRIPTION
4811208	Double wrap cable Sonic mobile (3,7m instead of 1,95m)

4811264



ART. NO.	DESCRIPTION
4811264	Battery 12V-440A (180x75x168mm) for mini 12V/440CA

48112...



ART. NO.	DESCRIPTION
4811209	Battery 12V - 700A (180x75x168mm) For Sonic micro 12V/700CA
4811210	Battery 12V - 800A (180x75x168mm) For Sonic micro 12V/800CA & Sonic 12/24V - 1600/800CA

48112...



ART. NO.	DESCRIPTION
4811211	Battery 12V - 1200A (250x95x158mm) For Sonic 12V/1200CA, 12/24 - 2400/1200CA & 24V/1200CA
4811212	Battery Cyclone 12V - 1600A (255x170x195mm) For Sonic Mobile 12V/1600CA, 12V/3200CA, 12/24V - 3200/1600CA

4811213



ART. NO.	DESCRIPTION
4811213	Internal armoured fuse 300A to protect the battery for all Sonic booster batteries 700A - 800A - 1000A

48148-2

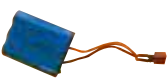

ART. NO.	DESCRIPTION
48148-2	Lithium battery 12V-1300A for hybrid booster

4811214



ART. NO.	DESCRIPTION
4811214	Internal armoured fuse 500A to protect the battery For all Sonic booster battery's 1200A - 1600A

4811215



ART. NO.	DESCRIPTION
4811215	External fuse 16A for all Sonic boosters

4811216



ART. NO.	DESCRIPTION
4811216	External automatic charger for booster 12V units: 12V/700CA.

4811217



ART. NO.	DESCRIPTION
4811217	External automatic charger for Sonic booster 12/800ca and 12v/1200CA

4811218



ART. NO.	DESCRIPTION
4811218	External automatic charger for Sonic boosters 12/24v - 1600/800ca and 2400/1200ca

4811219



ART. NO.	DESCRIPTION
4811219	Battery charger for Sonic booster 12/24V 3200-1600CA 7A

4811220



ART. NO.	DESCRIPTION
4811220	Male to male cord DC/DC for all Sonic booster 12V with 2 male cigarette lighter plugs to charge the booster on board of a vehicle 12V (engine running)

4811221



ART. NO.	DESCRIPTION
4811221	Male to male cord DC/DC for all Sonic Booster 12/24V With 4 male poles plug & cigarette lighter plug to charge the booster on board of a vehicle 12V (engine running)

48148-1



ART. NO.	DESCRIPTION
48148-1	Cable with cigarette lighter plug male 12V

48112...



ART. NO.	DESCRIPTION
4811222	Female cigarette lighter plug (for 12V)

4811223

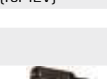

ART. NO.	DESCRIPTION
4811223	Male cigarette lighter plug (for 12V)

48112...

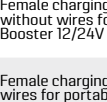

ART. NO.	DESCRIPTION
4811224	Female charging plug 4 poles without wires for portable Sonic Booster 12/24V

4811225



ART. NO.	DESCRIPTION
4811225	Female charging plug 4 poles with wires for portable Sonic Booster 12/24V

48112...

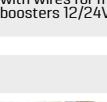

ART. NO.	DESCRIPTION
4811226	Female charging plug 4 poles without wires for mobile Sonic boosters 12/24V

4811227



ART. NO.	DESCRIPTION
4811227	Female charging plug 4 poles with wires for mobile Sonic boosters 12/24V

4811228

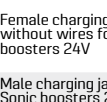

ART. NO.	DESCRIPTION
4811228	Male charging jack 4 poles for all Sonic boosters 12/24V

48112...



ART. NO.	DESCRIPTION
4811229	Female charging plug 2 poles without wires for all Sonic boosters 24V

ART. NO.	DESCRIPTION
4811230	Male charging jack 2 poles for all Sonic boosters 24V

48112...



ART. NO.	DESCRIPTION
4811231	Clamp red F600 for Sonic micro 12V/700A
4811232	Clamp blue F600 for Sonic micro 12V/700A

48112...



ART. NO.	DESCRIPTION
4811233	Clamp red 650A, bronze, fully insulated + copper tress
4811234	Clamp blue 650A, bronze, fully insulated + copper tress
4811235	Cable (25mm²) + clamp red 650A for Sonic micro 12V/800A
4811236	Cable (25mm²) + clamp blue 650A for Sonic micro 12V/800A

48112...



ART. NO.	DESCRIPTION
4811237	Cable (50mm²) + clamp red 850A for Sonic 12/24V - 2400/1200CA
4811238	Cable (50mm²) + clamp blue 850A for Sonic 12/24V - 2400/1200CA
4811239	Cable (35mm²) + clamp red 850A for Sonic 12v & 12/24V - 1600/800CA
4811240	Cable (35mm²) + clamp blue 850A for Sonic 12v & 12/24V - 1600/800CA

4811241



ART. NO.	DESCRIPTION
4811241	Voltmeter 8 to 16 volt for all Sonic boosters 12V & 12/24V

4811242



ART. NO.	DESCRIPTION
4811242	Push button for all Sonic boosters

4811243



ART. NO.	DESCRIPTION
4811243	Buzzer for all Sonic boosters with reverse polarity signal

4811244



ART. NO.	DESCRIPTION
4811244	S. connector yellow (SB175)

4811245



ART. NO.	DESCRIPTION
4811245	Handle for S. connector

Propulstation®



The Propulstation® is a real revolution in the world of jump starters. Developed for all professionals, it makes the emergency start of all vehicles even easier and more efficient! The unique docking station of the Propulstation® allows an automatic and optimal recharge of the booster in recovery vehicles but also in garages and workshops.

07



THE BATTERY: This is the heart of the device. Therefore, Sonic batteries have been designed with the main focus on delivering a maximum power at start. The battery has exceptionally high capacity to accumulate and disperse high-amperage energy. It uses pure lead plates and is an AGM (absorbed glass mat) type battery, outcome of aerospace technology and offers far superior performance and durability. Waterproof and dry, it can be stored in any position in perfect safety.

THE HOUSING: robust shell case design 5 mm shatterproof polyethylene ensures a high level of shock and daily use resistance. With a lifetime guarantee and modern esthetics that will always remain stylish and discrete thanks to its sober color.

THE CABLES: long and flexible with a double insulation, they have a cross-section capable of delivering the batteries full power. They offer a perfect resistance to extreme conditions. (-30 °c to 60 °C)

THE CLAMPS: the Propulstation® has robust, wide-opening clamps which are fully insulated and have a copper trace carrying the current to both of the bronze jaws and protecting the powerful spring against over-heating.



VOLTAGE DETECTION SYSTEM AND CORRECT CONNECTION SIGNAL: a LED system indicates the voltage to select on the booster. It reduces the risk of misuse while using a 12/24V booster. In the case of misuse any build up of gas will be evacuated. The LEDs also indicate if the booster is correctly connected to the station. If it is the case, the LED corresponding to the voltage of the charging circuit is lit on.

THE FUSE: the fuse is directly accessible from the outside of the booster. A spare fuse is available on the side of housing. A blue LED indicates the correct functioning of the fuse. If it does not light up when pushing on the red button, the fuse is blown.

UNIQUE ON THE MARKET CLAMPS: the massive clamps of the Sonic booster are fully insulated and ergonomic with big opening and a braided copper strap in order to spread current through both jaws. Clamps from other boosters are less user-friendly and don't deliver full current through both jaws. They are also less robust.

THE CONTACTOR: it revolutionizes and makes the storing of the booster in its station easier. Thanks to the powerful magnets, the booster is guided at its place avoiding any risk of bad connection. The contactor ensures an optimal recharge of the booster and avoids any movement while stored in the vehicle.

Propulstation®, when it's stored, it's charged!



07

5 ASSETS

ALWAYS IN THE RIGHT PLACE

In the workshop, the booster has its place and any user knows where to find and store it. In the vehicle, it is perfectly set in the station.

ALWAYS CHARGED AT 100%

Stored in its station, the booster is automatically and optimally charged between two starts.

100% SUCCESSFUL STARTS

Always at its maximal capacities, the booster ensures 100% successful starts.

A 3 TIMES LONGER LIFETIME

The optimal charge of the Propulstation® avoids the irreversible battery sulfation which is caused by the battery voltage dropping below 12,4V and will lead to premature failure of its battery.

ABSOLUTE PLEASURE OF USE

The user will benefit from the unlimited pleasure of working with a reliable and efficient tool.

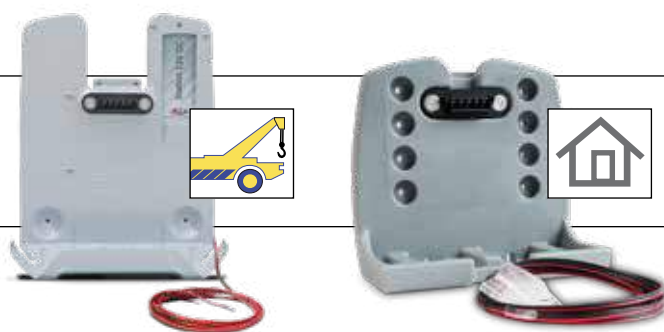

DOCKING STATION IN 2 VERSIONS

VEHICLE: the vehicle station must be connected to the recovery vehicle's battery by the DC/DC 12V/12V (or 24V/24V) lead. This has a one-way diode that prevents the breakdown vehicle from discharging the booster. The lighting and other equipment on the breakdown vehicle are heavy current consumers

WORKSHOP: the workshop station has a 230V/12V AC/DC charger to connect to the mains. Due to the weight of the portable booster 12/24 and 24V it is advised to mount the station on the floor.



PROPULSTATION® MOBILE THE POWER THAT ROLLS!

LARGE WHEELS: provide easy mobility on the most difficult terrain.

A THIRD WHEEL MULTIDIRECTIONAL: equipped with a brake ensures manoeuvrability and immobilization of the booster on an inclined surface.

ERGONOMIC HANDLES: designed to facilitate the movement of the booster in inclined and vertical positions, by pulling or pushing it.

Propulstation®



THE PROPULSTATION HAS TWO ELEMENTS:
 1) powerful start booster for professional use
 2) charging station

The fixed docking station will automatically charge the Propulstation® which results in an optimized power supply.



MODEL	12V/800CA	12V/1200CA	24V/1200CA	12/24V 2400/1200CA	12/24V 3200/1600CA	24V 1600CA
Voltage	12V	12V	24V	12/24V	12/24V	24V
Cranking amps	800A	1200A	1200A	2400/1200A	3200/1600A	1600A
Piek amps	2370A	3100A	3100A	6200/3100A	7750/3875A	3875A
Cable length	1,55 m	1,55 m	1,35 m	1,35 m	2,10 m	2,10 m
Radaflex welding cable size	35 mm ²	50 mm ²	50 mm ²	50 mm ²	70 mm ²	70 mm ²
Clamps	650A	850A	850A	850A	850A	850A
Internal fuse on the battery	300A	300A	500A	500A	500A	500A

PROPULSTATION (BOOSTER + CHARGING STATION)

ART. NO.	EXECUTION	SPECIFICATION	ART. NO.	EXECUTION	SPECIFICATION
48114	Vehicle	12V 800CA DC/DC	48122	Garage	24V 1200CA AC/DC
48115	Vehicle	12V 1200CA DC/DC	48123	Garage	12/24V 2400/1200CA AC/DC
48116	Garage	12V 800CA AC/DC	48127	Garage	12/24V 3200/1600CA AC/DC
48117	Garage	12V 1200CA AC/DC	48128	Vehicle	12/24V 3200/1600CA AC/DC
48120	Vehicle	24V 1200CA DC/DC	48129	Garage	24V 1600CA AC/DC
48121	Vehicle	12/24V 2400/1200CA dC/DC	48130	Vehicle	24V 1600CA AC/DC

LOOSE CHARGING STATIONS

ART. NO.	SPECIFICATION	ART. NO.	SPECIFICATION
48118	Charging station for vehicle 12V	48124	Charging station for vehicle 24V or 12/24V
48119	Charging station for garage 12V	48125	Charging station for garage 24V or 12/24V

Accu-smart®

Battery charger - multi stage charging

Did you know that your batteries suffer from self-discharge? Lead batteries get discharged even without being used! The loss of capacity can reach up to 6% per month (at 20°C) and even more by higher temperature. Yet below 12,4V, lead batteries start to sulphate. The more one battery is discharged and the longer it stays discharged, the more sulphate covers the lead plates inside. This sulphate will corrode the lead and damage the battery irreversibly. Moreover, contrary to other types of batteries, lead batteries do not suffer from memory effect and must be charged as often as possible. Ideally, the recharge must

be permanent and done with an electronic automatic charger. Accu-Smart® is therefore the essential tool for professionals and private users having vehicles stopped. These are a few examples:

- Old timer cars and motorbikes
- Agricultural and garden vehicles
- Leisure vehicles, motor homes
- Boats
- Vehicles in showrooms in stock or on parking lots
- Rental vehicles
- Mountain vehicles



MICROPROCESSOR CONTROLLED

Multi-stage charging for added precision, safety and battery life.



ECO FRIENDLY

Energy efficient meets the highest industry standards for energy efficiency.



LED DISPLAY INTERFACE

LED indicators show charging status Safety Reverse polarity, safety shut-off and spark proof, thermal runaway, ventilation system.



PROTECTIVE BUMPERS



HOOK ATTACHMENT
Allows unit to hang safely outside the work area.



ACCESSORIES
Insulated clamps and fused ring leads.

8 STEPS FOR AN OPTIMAL RECHARGE

- 1) ANALYSING BATTERY 2) RECOVERING BATTERY 3) SOFT START 4) BULK MODE 5) ABSORPTION 6) MONITORING 7) FLOAT MODE 8) MAINTAIN

TECHNICAL SPECIFICATIONS

MODEL	ACCU-SMART 12V-2A	ACCU-SMART 12V-4A	ACCU-SMART 12V-7A	ACCU-SMART 12V-10A
Ref Sonic	4811256	4811257	4811258	4811263
Input	220-240V AC 50HZ/60HZ, 0.5A	220-240V AC 50HZ/60HZ, 0.7A	220-240V AC 50HZ/60HZ, 1.3A	220-240V AC 50HZ/60HZ, 2.0A
Nominal output voltage	12V	12V	12V	12V
Max. output voltage	14.7V	14.7V	14.7V	14.7V
Max. output current	2A	4A	7A	10A
IP rate	IP20	IP20	IP20	IP20
Temperature range	-20--50°C	-20--50°C	-20--50°C	-20--50°C

ALWAYS A SOLUTION

08

***WORK
EFFICIENT
WORK
WITH SONIC***



**SONIC
TIMING
TOOLS**

Always the right tools for the job.

Sonic timing tools

829027 - ENGINE TIMING KIT BMW DIESEL M47 - 2.0

The 829027 has been developed to allow the engine timing to be set on the BMW M47 2.0L, 2.5L 4 cylinder diesel engines and the 3.0L 6 cylinder diesel engines found in BMW's, Rover 75 and Land Rover Freelander TD4 circa pre 2010.

COMPONENTS

REF	ART. NO.	OEM	DESCRIPTION
1	4880018	11-2-300, LRT-12-108, LRT-12-171	Crankshaft locking pin
2	4880022	11-6-320	Camshaft setting clamp
3	4880024	11-3-340	4mm loop pin (zinc plated)
4	4880023	11-6-322	Locking clamp assembly
5	4880038	11 5 180, LRT 12-227	Flywheel locking pin type 1 (BMW 115 180)
6	4880039	11 6 080	Flywheel locking pin body type 2 (BMW 116 080)

BMW - MINI

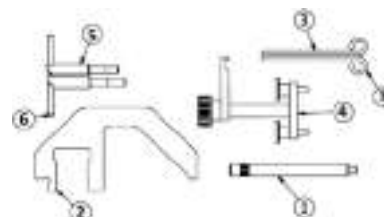

829028 - ENGINE TIMING KIT BMW PETROL N51, 52, 53, 54 - 2.3, 2.5, 2.8, 3.0 6 CYLINDER

The 829028 has been developed to allow the camshafts, vanos units and crankshaft to be locked in their timed position on the applications listed below. Applications: BMW

COMPONENTS

REF	ART. NO.	OEM	DESCRIPTION
1	4880259	11 4 280, 11 4 281, 11 4 282, 11 4 283, 11 4 285	Camshaft alignment tool (N51 & N52)
2	4880060	11 4 290, 11 8 520	4.0mm setting pin
3	4880059	11 0 300	Setting pin (MM23060 03A)
4	4880261	11 4 280, 11 4 281, 11 4 283	Camshaft locking plate for N53 & N54 engines assembly
5	4880026	11 9 340	Timing chain pre-tensioning tool assembly (11 9 340)
6	4880028	-	M6 x 30 hex head setscrew
7	4880010	-	Washers M6
8	4880047	-	Washer M8 zinc plated
9	4880211	-	M7 x 20 set screw

BMW - MINI

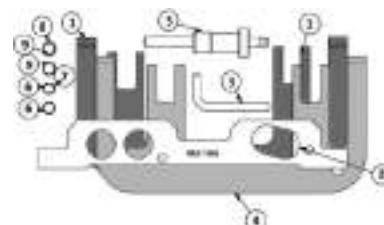

829029 - ENGINE TIMING KIT BMW PETROL N43 - 1.6, 2.0

The 829029 has been developed to allow the user to lock the camshafts and crankshaft in position on the BMW N43 chain driven petrol engines. The N43 engines are found in 1.6 and 2.0 versions from around 2006 up to the present day. There is a 7 piece kit (not including fixings) which include a camshaft alignment tool/locking plate, a camshaft sensor alignment tool, a crankshaft setting/locking pin, a timing chain pre tensioning tool, a balance shaft locking plate and 2 tensioner locking pins.

COMPONENTS

REF	ART. NO.	OEM	DESCRIPTION
1	4880025	11 5 120	Crankshaft setting pin-BMW
2	4880026	11 9 340	Timing chain pre-tensioning tool assembly (11 9 340)
3	4880024	11 3 340	4mm loop pin (zinc plated)
4	4880257	11 8 710 (11 8 711 11 8 712)	BMW camshaft position sensor tool assy (N43)
5	4880256	11 8 690 (11 8 691 11 8 692, 11 8 693)	Camshaft alignment tool (N43)
6	4880258	11 8 700	Balancer shaft alignment tool (N43)
7	4880169		M6x16 HT setscrew-S/Col
8	4880028		M6 x 30 hex head setscrew
9	4880010		Washers m6 form C Zc.PL.

BMW - MINI

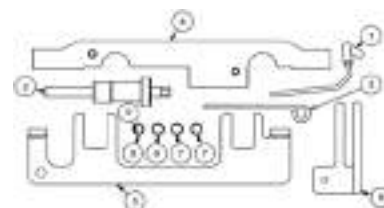

829030 - ENGINE TIMING KIT BMW, PSA PETROL N12, N14 -1.4, 1.6

The 829030 has been developed to allow the removal and fitting of the camshaft drive chains on the PSA/Mini 1,4 and 1,6 petrol engines.

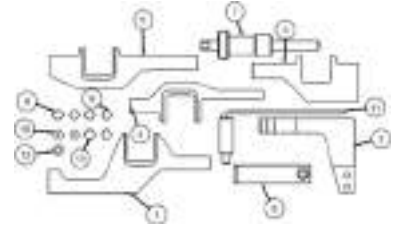
BMW - MINI

COMPONENTS

REF	ART. NO.	OEM	DESCRIPTION
1	4880035	119 540 / 0197-A3	Camshaft alignment tool body type 2 [of 2]
2	4880034	119540 / 0197-A3	Camshaft alignment tool body type 1 [of 2]
3	4880036	119 540 / 0197-A1	Camshaft alignment tool item 1 of 2 (OEM 119 540QC4 item 1)
4	4880030	119 550 / 0197-A2	Camshaft alignment tool (119 550/551) inlet setting plate
5	4880031	119 551	Camshaft alignment plate (OEM 119 550/551 - exhaust setting)
6	4880032	119 552	Support clamp BMW (OEM 119 550/552)
7	4880026	119 340	Timing chain pre-tensioning tool assembly (119 340)
8	4880134	-	M6 x 30 hex head setscrew black (self colour)
9	4880028	-	M6 x 30 hex head setscrew
10	4880322	-	Shank bolt 6 x 12 x M5 thread
11	4880033	119 590 / 0197-B	Crankshaft setting pin G.A-BMW
12	4880181	-	M6 x 20 H T setscrew S/C
13	4880216	-	M6 x 30 cap head screw

829031 - ENGINE TIMING KIT BMW, PSA PETROL N12, N14 -1.4, 1.6

The 829031 has been developed for the 1.6/1.8/2.0 BMW petrol engines found in the BMW 3, 5, X and Z4 series vehicles up to 2014.

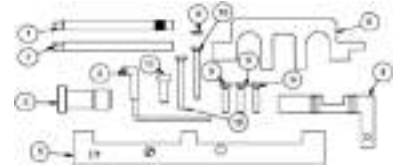
BMW - MINI

08

COMPONENTS

REF	ART. NO.	OEM	DESCRIPTION
1	4880018	11 5 120, 11 2 300	Crankshaft locking pin
2	4880025	119 190	Crankshaft setting pin-BMW
3	4880020	119 340	Large bush - preload tool
4	4880029	119 292	Inlet camshaft alignment tool-BMW 118i/120i
5	4880043	119 350	N42/N46 vanos sensor gear alignment tool
6	4880027	119 291	Exhaust Camshaft alignment tool assy.
7	4880021	-	Screw pre load tool item 2
8	4880010	-	Washers m6 form C Zc.PL.
9	4880028	-	M6 x 30 hex head setscrew
10	4880114	-	M6 x 55 H.T. Setscrew s/col
11	4880165	-	M8 x 25mm socket head cap screw

829032 - ENGINE TIMING KIT BMW PETROL N40, 45, 45T - 1.6

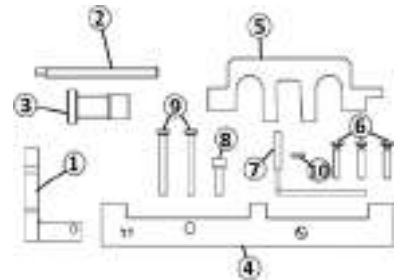
The 829032 has been developed to allow the user to check and adjust the camshaft timing and remove/replace the cam chain. The 829032 also includes the vanos plate which is required to lock the variable valve timing system in the correct position.

BMW - MINI

COMPONENTS

REF	ART. NO.	OEM	DESCRIPTION
1	4880042	11 7 252	Camshaft locking tool inlet side (OEM 11 7 252)
2	4880019	-	Screw pre load tool
3	4880020	119 340, 11 9 341	Large bush - preload tool
4	4880040	11 7 260	N40/N45 vanos sensor gear alignment Tool OEM 11 7 260
5	4880041	11 7 251	Camlock plate assembly exhaust side (OEM 11 7 250)
6	4880028	-	M6 x 30 hex head setscrew
7	4880025	119 190	Crankshaft setting pin-BMW
8	4880165	-	M8 x 25mm socket head cap screw
9	4880114	-	M6 x 55 H.T. Setscrew S/Col
10	4880010	-	Washers M6 form C Zc.PL.

Sonic timing tools

829033 - ENGINE TIMING KIT BMW, MINI DIESEL N47, 47S - 1.6, 2.0, 3.0

The 829033 has been developed to allow the user to check and adjust the camshaft timing and remove/replace the cam chain on the 1,6/2,0 and 3,0 BMW diesel engines found across the BMW range.

N.B: For some applications additional crankshaft holding tool OEM 11 4 320 may be required, sold separately as Sonic number: 829102 Front crankshaft holding tool; or OEM 11 7 220 tool available separately as Sonic 829105.

COMPONENTS

REF	ART. NO.	OEM	DESCRIPTION
1	4880044	11 6 480	Crankshaft pulley turning tool [11 6 480]
2	4880045	11 8 740	Hi pressure pump sprocket retainer [11 8 740]
3	4880046	11 5 320	Flywheel plate timing pin [OEM 11 5 320]
4	4880037	11 8 760	Camshaft alignment tool BMW OEM 11 8 760
5	4880024	11 3 340	4mm loop pin (zinc plated)

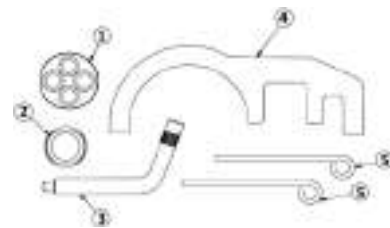

BMW - MINI



829034 - ENGINE TIMING KIT BMW PETROL N62, 73 - 3.6, 4.0, 4.4, 4.8, 6.0, V8, V12

The 829034 has been developed for BMW N62 V8 and N73 V12 engines. The 829034 kit allows the user to check and hold the valve timing whilst maintaining the correct timed position of the camshafts and crankshaft.

COMPONENTS

REF	ART. NO.	OEM	DESCRIPTION
1	4880025	11 9 190	Crankshaft setting pin-bmw
2	4880207	11 9 461	Bmw inlet camshaft gauge plate [OEM 11 9 461]
3	4880208	11 9 462	Bmw exhaust camshaft gauge plate [OEM 11 9 462]
4	4880209	11 9 463	Clamp assembly [N62 / N73]

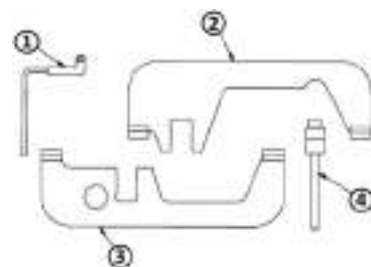

BMW - MINI



829097 - BALANCE SHAFT SETTING KIT BMW DIESEL N47 - 2.0

829097 has been designed to set the balance shafts on BMW N47 diesel engines when the balance shafts have been disturbed also includes the crankshaft setting bridge required to set the crankshaft in its bottom dead centre (BDC) number 1 position.(see application list).

COMPONENTS

REF	ART. NO.	OEM	DESCRIPTION
A	4880291	11 8 750	BMW balancer shaft locating tool
B	4880292	11 8 790, 11 8 791, 11 8 793	BMW crankshaft locator tool

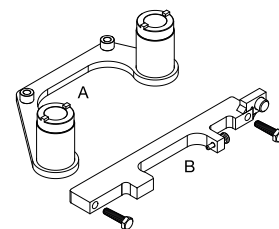

BMW - MINI



829101 - BALANCE SHAFT SETTING KIT BMW

BMW - N40, N42, N43, N45, N46, N49, N52
829101 has been specifically designed to set the balance shafts on BMW engines when the balance shafts have been disturbed.
Equivalent to OEM 11 7 700, 11 5 140, 11 9 280, 11 9 330

COMPONENTS

REF	ART. NO.	OEM	DESCRIPTION
1	4880286	11 8 700	BMW balancer shaft locking tool [119 330]
2	4880287	11 5 140	BMW balancer shaft holding tool [115 140]
3	4880288	11 9 280	BMW crankshaft holding tool
4	4880258	11 9 330	Balancer shaft alignment tool [N43]

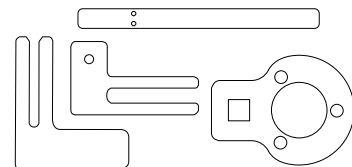

BMW - MINI



829102 - CRANKSHAFT HOLDING TOOL BMW DIESEL N47/57 - 1.6/2.0/3.0
BMW - MINI

829102 is a crankshaft locking and holding tool is designed to lock the crankshaft on the N47 (2.0L) and N57 (3.0L) diesel engines from 2007 found in the BMW range. It is specifically required when replacing or repairing the secondary drive chains on the engines listed. Additional camshaft or balance shaft tooling may be required. Equivalent to OEM 11 4 320.

COMPONENTS

REF	ART. NO.	OEM	DESCRIPTION
1	4880301	11 4 320	Machining detail for BMW N47 & N57 crankshaft locking tool
2	4880302	-	Pin for BMW N47 & N57 crankshaft locking tool (11 4 320)
3	4880110	-	M5 x 10mm countersunk socket black
4	4880169	-	M6x16 HT setscrew-s/col
5	4880010	-	Washers M6 form C Zc. PL
6	4880328	-	M6 fullnut

829104 - AUXILIARY DRIVE BELT WRENCH SET PETROL BMW MINI - 1.6
BMW - MINI

This tool set simplifies the removal and replacement of the serpentine belt when servicing or repairing the W10, W11 1600cc engines as used in the Mini One, Cooper & Cooper S (pre. 2007 Mk1), Mini Convertible (pre 2009 Mk1).

COMPONENTS

REF	ART. NO.	OEM	DESCRIPTION
1	4880138	11 8 410	Belt tensioner assembly
2	4880139	11 8 390	BMW mini camshaft pulley wrench (11 8 390)
3	4880002, 4880003	11 8 470 & 11 8 280	Ø4mm tensioner pin + Ø4.5mm tensioner pin

08
829105 - FRONT PULLEY HOLDING TOOL BMW N47/N57 DIESEL ENGINE 1.6/2.0/3.0
BMW - MINI

829105 is a special crankshaft pulley holding tool for the N47/N57 BMW diesel engines found across the BMW and Mini ranges. Designed to hold the crankshaft pulley stationary while loosening or tightening the centre bolts of the pulley. Equivalent to OEM 11 7 220

COMPONENTS

REF	ART. NO.	OEM	DESCRIPTION
1	4880221	11 7 220	Brace welded assy
2	4880220		Threaded boss
3	4880333		M16 flat washer form a to DIN 125A
4	4880327		Lock nut M16 x 1.5 24mm A/F 8mm thk chemi black
5	4880213		M10 x 100 SKT HD cap screw
6	4880217		M8 x 100mm cap head



Sonic timing tools

829121 - TIMING CHAIN LOCKING KIT PSA/BMW 1,4/1,6 PETROL

A complete engine timing kit designed to allow the timing to be set and checked on the 1.4 | 1.6 PSA | BMW engines found in the BMW, Mini and PSA ranges. Engine codes covered include N12, N13, N14, N16 and N18 for BMW | Mini and EP3, EP6 for Citroën | Peugeot from 2006 to 2016.

COMPONENTS

REF	ART. NO.	OEM	DESCRIPTION
1	4880375	-	Inlet camshaft alignment tool
2	4880372	-	Exhaust camshaft alignment tool
3	4880349	-	M10 x 15lg caphead screw to iso 4762
4	4880378	-	Camshaft alignment tool-2 base plate
5	4880358	-	Flywheel timing pin for psa 1.0 & 1.2 assembly
6	4880416	-	M5x16 c/sink skt head screw
7	4880373	-	Exhaust camshaft alignment tool adapter 2
8	4880380	-	Link bar for a & b
9	4880377	-	Inlet camshaft alignment tool adapter 1
10	4880379	-	Camshaft alignment tool adapter -5
11	4880374	-	Exhaust camshaft alignment tool adapter 2
12	4880379	-	Exhasut camshaft alignment tool adapter 3
13	4880415	-	Angle bracket
14	4880371	-	Dummy timing chain tensioner
15	4880415	-	Digital inclinometer is a digital angle gauge or digital protractor

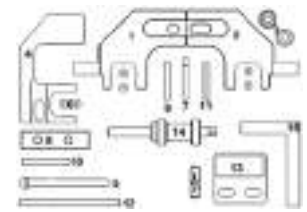

BMW - MINI



829131 - BALANCE SHAFT ALIGNMENT TOOL - BMW B47/B48N47

Specifically designed to offer an alignment solution for the BMW 1.6 and 2.0L N47, B47 and B48 diesel engines found across the BMW range from as early as 2008 up to 2016. The set combines the BMW N47 balance shaft locking tool and the B47/B48 locking tools into one simple to use tool. The innovative EU registered design eliminates the requirement for a separate crankshaft alignment tool by combining the functionality of the OEM tools 11 8 790, 11 8 750 and 2 288 054 into one tool with interchangeable balance shaft alignment adaptors. 829131 supersedes Sonic Equipment 829097.

COMPONENTS

REF	ART. NO.	OEM	DESCRIPTION
1	4880404	2 288 054	Balancer shaft alignment tool base assembly
2	4880405	83 20 2 288 054	Balancer shaft alignment tool base assembly
3	4880406	-	M8 x 30 cap head
4	4880353	11 8 750	Bmw N47 spigot for bmw balance shaft holding tool
5	4880346	-	Ht bolt M10 x 50 self colour



BMW - MINI

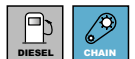

829017 - ENGINE TIMING KIT OPEL, CHEVROLET, FIAT PETROL - 1.6, 1.8 16V

The 829017 has been developed to allow the user to change the cam belt on the later Z and A coded GM Petrol belt driven engines. These engines are also found in Fiat and Alfa Romeo vehicles as listed below.

COMPONENTS

REF	ART. NO.	OEM	DESCRIPTION
1	4880234	KM-6625	Flywheel holding tool (KM-6625)
2	4880168	KM-911	Flywheel locking tool item 2
3	4880185	KM6130, KM6349	Auxilliary drive belt tensioner locking pin (4 x 55)
4	4880239	KM-6628A, 2 000 012 000	Camshaft locking tool (GM)
5	4880057	KM-6340, 2 000 012 100	Cam locking tool (pair)
6	4880058	KM-6333	Locking pin

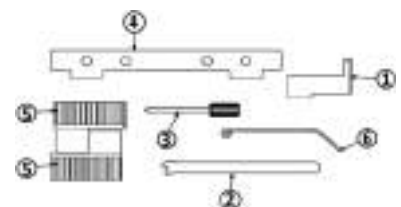

CHEVROLET - CHRYSLER DODGE



829061 - ENGINE TIMING KIT OPEL/CHEVROLET DIESEL (Z20) - 2.0
CHEVROLET - CHRYSLER DODGE

Developed for the Vauxhall/Chevrolet 2.0 common rail diesel engine found in the Vauxhall Antara, Chevrolet Captiva, Cruze, Epica, Lacetti and Nubira. This kit holds the correct timing position of the crankshaft and camshaft whilst changing the timing belt on the 16V SOHC belt driven diesel engines.

COMPONENTS

REF	ART. NO.	OEM	DESCRIPTION
1	4880012	EN-48245	Camshaft locking tool assembly (EN48245)
2	4880011	EN-48246	Crankshaft locking pin (EN48246)

829064 - ENGINE TIMING KIT OPEL/CHEVROLET/SAAB PETROL (A20/A24) - 2.0, 2.4
CHEVROLET - CHRYSLER DODGE

Developed specifically for the high power output 2.0 litre and 2.4 litre twin cam turbo charged petrol engines found across the GM, Chevrolet and Saab ranges. This kit provides all the components required to set and hold the camshafts, crankshaft and chain tensioner components when performing major engine work or replacing the cam chain and associated components.

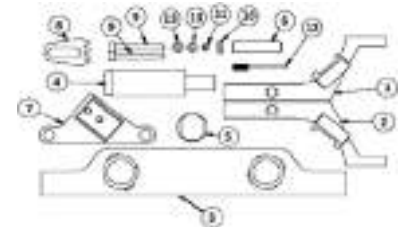
COMPONENTS

REF	ART. NO.	OEM	DESCRIPTION
1	4880231	EN-49212, EN-49212-1	Vauxhall - Opel - camshaft locking tool LHS (OEM ref: EN-492)
2	4880232	EN-49212, EN-49212-2	Vauxhall - Opel - camshaft locking tool RHS (OEM ref: EN-492)
3	4880317	EN-48953	Camshaft adjuster holding tool
4	4880318	EN-48585	Crankshaft bolt hole balancer
5	4880320	J45027-2, EN45027-2, EN-45027,	Tension plunger holder
6	4880321	EN-45027-1, J-45027-1	Tension plunger remover
7	4880319	EN-43653, J43653	Flywheel holding tool bottom half
8	4880135	EN-43653, J43653	Flywheel holding tool
9	4880214	-	M6 x 50 caphead screw
10	4880010	-	Washers M6 form C Zc.PL
11	4880173	EN-955-20, KM 955-20	Tensioner location pin 4mm
12	4880172	EN-955-10, KM955	Tensioner location pin 2.5mm
13	4880215	-	M6 x 16 cap head screw self-colour to BS4168

08
829083 - ENGINE TIMING KIT CHRYSLER/LDV DIESEL CRD - 2.5, 2.8
CHEVROLET - CHRYSLER DODGE

The 829083 kit was developed for the Chrysler DOHC common rail diesel engine found in the Voyager, Grand Voyager and the LDV Maxus van. The 829083 kit allows the user to replace the timing belt whilst maintaining the correct timed position of the camshafts and crankshaft.

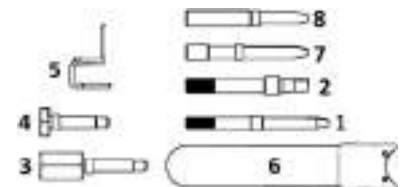
COMPONENTS

REF	ART. NO.	OEM	DESCRIPTION
1	4880222	VM.1089, LDV196	Chrysler 2.5/2.8 CRD timing pin - VM.1089
2	4880223	VM.1068, LDV196	Timing pin (chrysler 2.5/2.8 CRD VM.1068)
3	4880224	VM.1052, LDV192	Timing pin (chrysler 2.5/2.8 CRD VM.1052)
4	4880225	VM.1053, LDV193	Timing pin (chrysler 2.5/2.8 CRD VM.1053)
5	4880226	VM1074	Timing belt retaining spring (VM.1074)
6	4880015	VM.9660, H2587	Tension wrench
7	4880282	VM.1080	Chrysler timing pin (VM.1080)
8	4880283	VM.8873	Chrysler timing pin (VM.8873)

Sonic timing tools

829084 - ENGINE TIMING KIT CHRYSLER/JEEP DIESEL CRD - 2.8

The 829084 kit has been developed specifically for the 2008 and later 2.8 CRD Chrysler/Jeep engines where the cam belt drives one camshaft and the second camshaft is driven via gears. The 829084 kit is a 2 piece kit consisting of the components required to lock the crankshaft and camshafts in their timed position to allow the removal and replacement of the cam belt and associated components.

COMPONENTS

REF	ART. NO.	OEM	COMPONENTS
1	4880284	VM.9992	Chrysler crankshaft locking tool [VM.9992]
2	4880285	VM.9991	Chrysler exhaust camshaft locking tool [VM.9991]

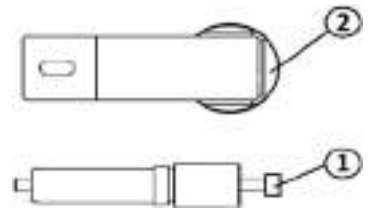

CHEVROLET - CHRYSLER DODGE



829085 - ENGINE TIMING KIT CHRYSLER/JEEP DIESEL CRD - 3.0

The 829085 kit has been designed for the Jeep 3.0 lt V6 diesel engine found in the late model (2011 on) Jeep Grand Cherokee. The 829085 provides all the cam and crankshaft locking tools required for chain replacement.

COMPONENTS

REF	ART. NO.	OEM	DESCRIPTION
1	4880311	VM10338-1	Camshaft locking tool RH - assy
2	4880310	VM10338-2	Camshaft locking tool LH - assy
3	-	-	Cap head screws for reference 1
4	4880313	VM10359a	Crankshaft timing pin assy
5	4880312	VM10339	Tensioner locking pin

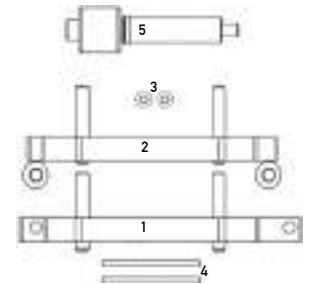

CHEVROLET - CHRYSLER DODGE

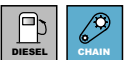

829086 - ENGINE TIMING KIT MERCEDES-BENZ/CHRYSLER CRD - 2.2, 2.7

The 829086 covers a large range of vehicles fitted with chain driven engines from Mercedes-Benz including the PT Cruiser 2.2 CRD and Jeep Grand Cherokee 2.7 CRD from Chrysler.

COMPONENTS

REF	ART. NO.	OEM	DESCRIPTION
1	4880203	602 589 00 40 00 8929	Flywheel locking tool
2	4880206	602 589 00 40 00 8929	Camshaft locking pin assy
3	4880205	601 589 02 40 00 8933	Flywheel locking tool Mercedes-Benz 602 589 00 40 00
4			Bolts for reference 3

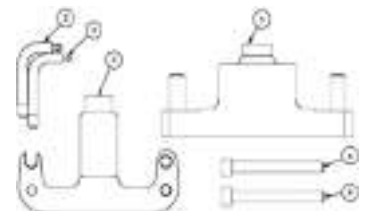

CHEVROLET - CHRYSLER DODGE

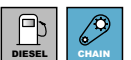

829087 - ENGINE/BALANCE SHAFT TIMING KIT MERCEDES-BENZ DIESEL (651) - 1.8, 2.1

The 829087 has been specifically designed for Mercedes-Benz vehicles fitted with the chain driven 1.8/2.1 CDI diesel engines (engine code pre fix 651). These engines are found across the Mercedes-Benz range including A, B, C, E, G and S class as well as the Sprinter and Vito vans from as early as 2007 up to 2015. These engines are also found in the Jeep and Dodge ranges. The 829087 contains the essential alignment tools to align the camshafts, crankshaft and balance shafts in one compact kit.

COMPONENTS

REF	ART. NO.	OEM	DESCRIPTION
1	4880316	651 589 01 40 00	Camshaft alignment tool
2	4880315	651 589 00 40 00	Crankshaft holding/turning tool
3/4/5/6	4880314	651 589 02 63 00	Balance shaft lock tool assy

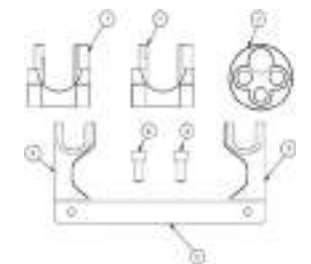

CHEVROLET - CHRYSLER DODGE



829015 - ENGINE TIMING KIT FIAT, OPEL, SAAB JTD DIESEL - 1.6, 1.9, 2.0, 2.4

The 829015 engine timing kit has been put together to provide the essential crankshaft and cam shaft timing pins only for the Fiat/Opel JTD diesel engines found across the Fiat, Opel, Saab ranges.

COMPONENTS

REF	ART. NO.	OEM	DESCRIPTION
1	4880188	1.870.896.900, EN-46789, 32 025 008	Camshaft alignment tool
2	4880136	1.860.898.000	Flywheel locking tool
3	4880137	-	Stud assy
4	4880218	-	M8 x 20mm socket head screw
5	4880091	1.860.965.000	Setting pin (chem. black) [6 X 60]
6	4880187	1.860.905.000, 1.860.905.010, 2.000.003.000, EN-46788, 32 025 009	Crankshaft alignment tool

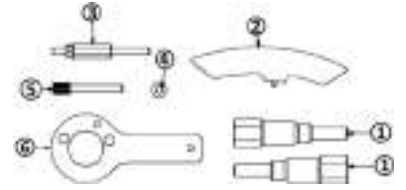
FIAT - ALFA ROMEO
829016 - ENGINE TIMING & REBUILD SET FIAT, OPEL, FORD, PSA JTD DIESEL - 1.3

The 829016 has been developed to allow the user to change the cam chain on the later 1.3 JTD/CDTi & HDi diesel engines found in the PSA, Fiat, Ford, Suzuki and Opel ranges.

COMPONENTS

REF	ART. NO.	OEM	DESCRIPTION
1	4880200	1 871 000 200, 303-1469, KM-662-C	Crankshaft pulley flange holding tool
2	4880004	1 870 900 400	Timing chain tensioning tool
3	4880005	0104-C, 1 870 900 300, 303-1468	Crankshaft alignment tool
4	4880183	0104-A, 1 871 000 900, 1 860 985 000, EN 46781, 09917-68610	Camshaft alignment tool assy
5	4880186	EN 46785, 09912-38300	Crankshaft pin assy
6	4880096	Fiat 8mm pin	Locking pin (8mm dia. 70 long)

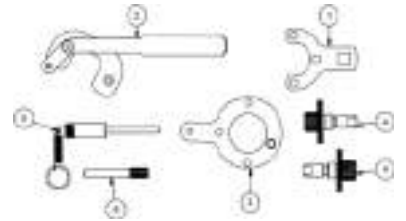
FIAT - ALFA ROMEO
829017 - ENGINE TIMING KIT OPEL, CHEVROLET, FIAT PETROL - 1.6, 1.8 16V

The 829017 has been developed to allow the user to change the cam belt on the later Z and A coded GM Petrol belt driven engines. These engines are also found in Fiat and Alfa Romeo vehicles as listed below.

COMPONENTS

REF	ART. NO.	OEM	DESCRIPTION
1	4880234	KM-6625	Flywheel holding tool (KM-6625)
2	4880168	KM-911	Flywheel locking tool item 2
3	4880185	KM6130, KM6349	Auxilliary drive belt tensioner locking pin (4 x 55)
4	4880239	KM-6628A, 2 000 012 000	Camshaft locking tool (GM)
5	4880057	KM-6340, 2 000 012 100	Cam locking tool (pair)
6	4880058	KM-6333	Locking pin

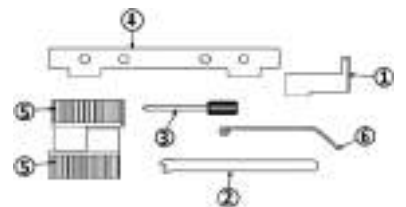
FIAT - ALFA ROMEO
829018 - ENGINE TIMING KIT FIAT, PSA, IVECO JTD DIESEL - 2.8

The 829018 has been developed for Fiat 2.8 diesel engines that are found in the Fiat, Iveco and PSA van ranges. This kit provides all the tools required to set the timed components when replacing the timing belt. The kit also includes the components require to lock the flywheel when undoing and tightening up the front pulley fixings as well as the special spacer to hold the belt tensioner in its fully retracted position.

COMPONENTS

REF	ART. NO.	OEM	DESCRIPTION
1	4880237	1 870 765 001	Flywheel locking piece (Fiat)
2	4880090	1 860 617 000	Setting pin 5.0mm [5 x 50]
3	4880097	8mm pin	Locking pin [8mm dia. x 60 long]
4	4880132	1 860 638 000	Tensioning tool

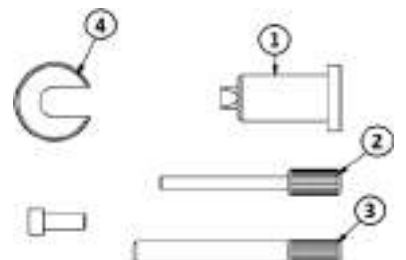
FIAT - ALFA ROMEO

Sonic timing tools

829019 - ENGINE TIMING KIT FIAT T JET PETROL - 1.2, 1.4

The 829019 has been developed to lock the cam and crankshaft in position to allow the removal and replacement of the timing belt fitted to the 1,2/1.4 T-Jet Fiat petrol engines.

COMPONENTS

REF	ART. NO.	OEM	DESCRIPTION
1	4880182	1 860 992 000	Piston height gauge
2	4880183	1 860 985 000, 1 871 000 900	Camshaft alignment tool assy
3	4880184	1 860 987 000	Tension wrench
4	4880233	2 000 015 800	Spigot lock assembly
5	4880006	2 000 004 500	Crankshaft alignment tool



FIAT - ALFA ROMEO

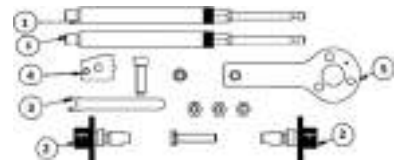

829020 - ENGINE TIMING KIT FIAT MULTI AIR PETROL - 1.4

The 829020 has been developed to lock the cam and crankshaft in position to allow the removal and replacement of the timing belt fitted to the current generation 1.4 Fiat MultiAir engines.

COMPONENTS

REF	ART. NO.	OEM	DESCRIPTION
1	4880006	2 000 004 500	Crankshaft alignment tool
2	4880137	2 190 754 200	Stud assy
3	4880263	2 000 034 400	Fiat/Alfa multi air camshaft locking tool assy
4	4880184	1 860 987 000	Tension wrench
5	4880218	-	M8 x 20mm socket head screw



FIAT - ALFA ROMEO

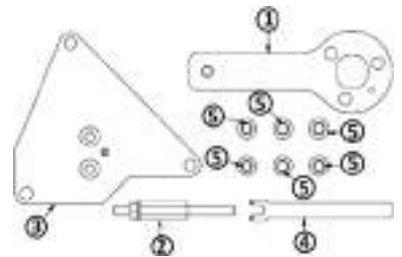

829021 - ENGINE TIMING KIT FIAT TWIN AIR PETROL - 0.9

The 829021 has been developed to lock the cam and crankshaft in position to allow the removal and replacement of the timing belt fitted to the current generation 1.4 Fiat MultiAir engines.

COMPONENTS

REF	ART. NO.	OEM	DESCRIPTION
1	4880266	2 000 035 100	Fiat/Alfa twin air camshaft locking tool
2	4880265	2 000 035 200	Timing pin for Fiat twin air 0.9 timing set - straight
3	4880264	2 000 035 300	Timing pin for Fiat twin air 0.9 timing set - bent
4	4880165	-	M8 x 25mm socket head cap screw
5	4880218	-	M8 x 20mm socket head screw



FIAT - ALFA ROMEO

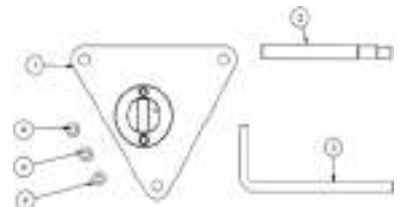

829022 - TWIN CAMSHAFT LOCKING TOOL OPEL, FIAT PETROL - 2.2

The 829022 has been developed to lock the cam and crankshaft in position to allow the removal and replacement of the timing belt fitted to the current generation 1.4 Fiat MultiAir engines.

COMPONENTS

REF	ART. NO.	OEM	DESCRIPTION
1	4880179	KM 6148	Camshaft locking tool (assembled)
2	4880180	KM 6077	Tension pin 1.0



FIAT - ALFA ROMEO

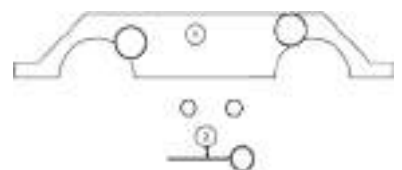

829023 - ENGINE TIMING KIT FORD, PSA, FIAT TDCI, HDI DIESEL - 1.4, 1.5, 1.6

The 829023 is an engine timing kit specifically designed for the Ford/PSA 1.4/1.6 TDCI/HDI diesel engines found across the Ford, PSA and Fiat ranges.

COMPONENTS

REF	ART. NO.	OEM	DESCRIPTION
1	4880090	303-732, 21-260	Setting pin 5.0mm [5 x 50]
2	4880096	303-735, 21-263	Locking pin [8mm dia. 70 long]
3	4880064	303-734, 21-262	Flywheel locking pin [12 x 55]
4	4880061	303-393, 21-168	Flywheel locking tool-Ford
5	4880062	303-393-01	Tooth block item 2
6	4880063	303-293-02	Short tooth block

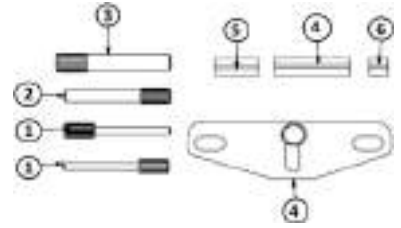
FIAT - ALFA ROMEO

829024 - ENGINE TIMING KIT FIAT, FORD PETROL - 1.2 8V

The 829024 is an engine locking kit designed for the Fiat 1.2 petrol engines.

COMPONENTS

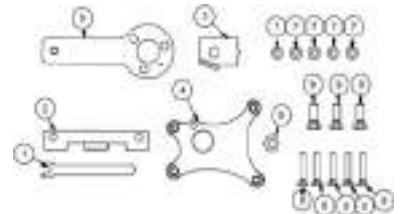
REF	ART. NO.	OEM	DESCRIPTION
1	4880184	1 860 987 000	Tension wrench
2	4880007	2 000 004 400, 2 190 754 400	Camshaft alignment strap - machined
3	4880008	2 000 004 200, 2 190 754 200	Camshaft sprocket locking tool
4	4880009	2 000 004 300	Camshaft cover alignment tool
5	4880006	2 000 004 500, 2 190 754 500	Crankshaft alignment tool
6	4880202	-	Skt HD capscrew M10x20
7	4880010	-	Washers M6
8	4880329	-	M6 set screw 30mm long zinc
9	4880332	-	M8 x 20 H.T. setscrew

FIAT - ALFA ROMEO

08
829025 - ENGINE TIMING KIT FIAT JTD DIESEL - 2.3, 3.0

The 829025 is an engine timing locking tool set for Fiat Ducato 2.3 JTD. This kit includes the latest crankshaft timing pin required on engines produced from 2006-2008. The 2.3 JTD twin camshaft common rail diesel engines are belt driven between crankshaft and inlet camshaft but utilise a chain to connect both camshafts.

COMPONENTS

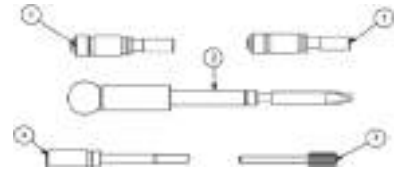
REF	ART. NO.	OEM	DESCRIPTION
1	4880130	99360614	Camshaft alignment barrel assembly
2	4880131	99360615	Crankshaft timing pin
3	4880090	1 860 617 000	Setting pin 5.0mm [5 x 50]
4	4880001	2 000 018 200	Balancer shaft locking screw - Rover/Honda

FIAT - ALFA ROMEO

829026 - ENGINE TIMING KIT FIAT, PSA, OPEL, IVECO JTD DIESEL - 2.5

The 829026 is a small diesel locking kit specifically assembled to cover the 2.5/2.8 belt driven diesel engines found in the Citroën, Peugeot, Renault and Fiat ranges.

COMPONENTS

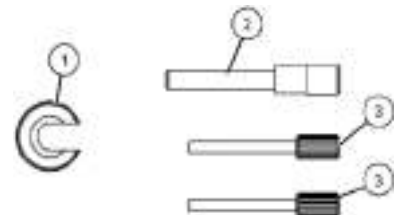
REF	ART. NO.	OEM	DESCRIPTION
1	4880132	1 860 638 000	Tensioning tool
2	4880095	1 870 667 000, 1 870 765 001	Locking pin (zinc pl.)
3	4880090	1 860 617 000	Setting pin 5.0mm [5 X 50]

FIAT - ALFA ROMEO

Sonic timing tools

829039 - ENGINE TIMING KIT FIAT, OPEL, FORD, PSA JTD DIESEL - 1.3

The 829039 engine timing kit allows the valve timing to be set on the current 1,3 Multijet Fiat derived diesel engines found across the Fiat, Ford, Opel & PSA ranges.

COMPONENTS

REF	ART. NO.	OEM	DESCRIPTION
1	4880135	153A	Flywheel holding tool
2	4880183	21 860 985 000, EN 46781, 303-1472, 0104-A	Camshaft alignment tool assy.
3	4880005	1 870 900 300, 303-1468, 0104-C	Crankshaft alignment tool
4	4880280	303-1475, 1 871 008 600	Ford 1.3 diesel camshaft support tool Ø36 ID



FIAT - ALFA ROMEO

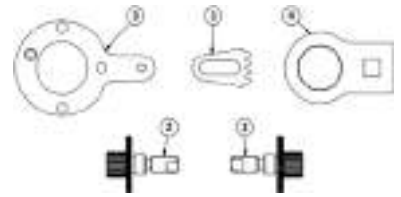

829041 - ENGINE TIMING & REBUILD SET PSA, FIAT DW10, DW12 - 2.0, 2.2

The 829041 kit brings together the tools required to set the valve timing on the extensive range of DW10 2,0 and DW12 2,2 Diesel engines as well as the DV4 1,4 and DV6 1,6 diesel engines found across the PSA and Fiat ranges.

COMPONENTS

REF	ART. NO.	OEM	DESCRIPTION
1	4880072	7099-TM	Crankshaft pin - 8 X 380
2	4880112	0188K, 0132AK, 0153AK, 0187J, 4533-TAD	Timing belt Retaining clip
3	4880113	0188P, 7015-T, 0188P2	Puller beam
4	4880068	303-1059	Timing pin
5	4880080	0188AH	Centraliser spring - 1.4mm dia
6	4880106	0188F	Flywheel lock (zinc PL.)
7	4880108	0188J2	Tension adjustment tool
8	4880097	0188M	Locking pin (8mm dia x 60)
9	4880227	0188Q2	2mm formed locking pin (BZP) 210 x 50
10	4880228	0153AL	3mm formed locking pin (yellow passivate)
11	4880060	0188Q1	4.0mm setting pin
12	4880104	0188J/J1	Tension adjustment tool
13	4880096	0189B	Locking pin (8mm dia. 70 long)
14	4880090	0178D, 303-732, 0194A	Setting pin 5.0mm (5 x 50)
15	4880064	303-734, 0194C	Flywheel locking pin (12 x 55)
16	4880255	0.532Y, 9967.34	8mm multi-bend flywheel timing pin



FIAT - ALFA ROMEO

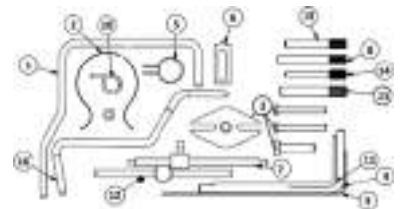

829063 - ENGINE TIMING KIT OPEL/FIAT/FORD/PSA DIESEL JTD/HDI - 1.3

This is an essential engine timing tool set that provides the camshaft and crankshaft timing tools only.

COMPONENTS

REF	ART. NO.	OEM	DESCRIPTION
1	4880183	104-A, EN 46781	Camshaft alignment tool assy
2	4880186	-	Crankshaft pin assy
3	4880096	EN-46785	Locking pin (8mm dia. 70 long)



FIAT - ALFA ROMEO

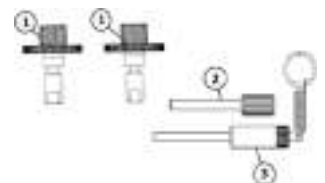

829088 - CAMSHAFT HOLDING TOOL FIAT/FORD/OPEL DIESEL JTD - 1.3
FIAT - ALFA ROMEO

The 829088 camshaft pulley holding tool has been designed to allow the user to loosen and tighten the camshaft pulley fixings without moving the camshafts or causing damage to any timing tools that may be fitted. Conveniently designed to allow the use of a ½ drive wrench the 829088 combines the double headed OEM tool into one single tool.

COMPONENTS

REF	ART. NO.	OEM	DESCRIPTION
1	829088	1 871 008 600 303-1475	Camshaft holding tool Fiat/Ford/Opel diesel JTD - 1,3

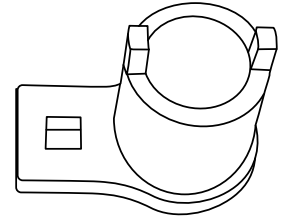
829016 - ENGINE TIMING & REBUILD SET FIAT, OPEL, FORD, PSA JTD DIESEL - 1.3
FORD

The 829016 has been developed to allow the user to change the cam chain on the later 1.3 JTD/CDTi & HDi diesel engines found in the PSA, Fiat, Ford, Suzuki and Opel ranges.

COMPONENTS

REF	ART. NO.	OEM	DESCRIPTION
1	4880200	1 871 000 200, 303-1469, KM-662-C	Crankshaft pulley flange holding tool
2	4880004	1 870 900 400	Timing chain tensioning tool
3	4880005	0104-C, 1 870 900 300, 303-1468	Crankshaft alignment tool
4	4880183	0104-A, 1 871 000 900, 1 860 985 000, EN 46781, 09917-68610	Camshaft alignment tool assy
5	4880186	EN 46785, 09912-38300	Crankshaft pin assy
6	4880096	Fiat 8mm pin	Locking pin (8mm dia. 70 long)

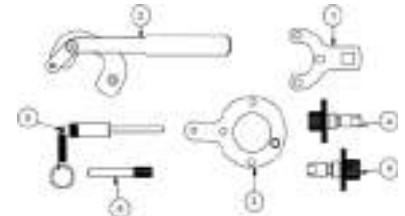
08
829023 - ENGINE TIMING KIT FORD, PSA, FIAT TDCI, HDI DIESEL - 1.4, 1.5, 1.6
FORD

The 829023 is an engine timing kit specifically designed for the Ford/PSA 1.4/1.6 TDCI/HDi diesel engines found across the Ford, PSA and Fiat ranges.

COMPONENTS

REF	ART. NO.	OEM	DESCRIPTION
1	4880090	303-732, 21-260	Setting pin 5.0mm [5 x 50]
2	4880096	303-735, 21-263	Locking pin (8mm dia. 70 long)
3	4880064	303-734, 21-262	Flywheel locking pin (12 x 55)
4	4880061	303-393, 21-168	Flywheel locking tool-Ford
5	4880062	303-393-01	Tooth block item 2
6	4880063	303-293-02	Short tooth block

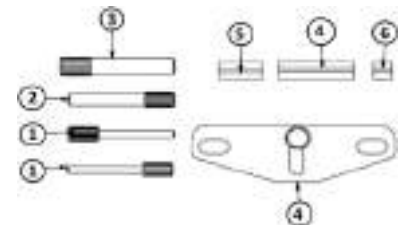
829024 - ENGINE TIMING KIT FIAT, FORD PETROL - 1.2 8V
FORD

The 829024 is an engine locking kit designed for the Fiat 1.2 petrol engines.

COMPONENTS

REF	ART. NO.	OEM	DESCRIPTION
1	4880184	1 860 987 000	Tension wrench
2	4880007	2 000 004 400, 2 190 754 400	Camshaft alignment strap - machined
3	4880008	2 000 004 200, 2 190 754 200	Camshaft sprocket locking tool
4	4880009	2 000 004 300	Camshaft cover alignment tool
5	4880006	2 000 004 500, 2 190 754 500	Crankshaft alignment tool
6	4880202	-	Skt HD capscrew M10x20
7	4880010	-	Washers M6
8	4880329	-	M6 set screw 30mm long zinc
9	4880332	-	M8 x 20 H.T. setscrew

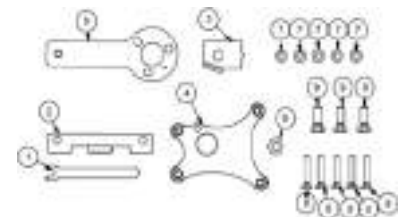

Sonic timing tools

829040 - ENGINE TIMING KIT JAGUAR LAND ROVER, FORD, PSA DIESEL DW12 - 2.2

The 829040 is a compact tool set which includes the camshaft sprocket, flywheel locking tools and flywheel timing pin required when setting the valve timing and/or changing the timing belt on DW12 (2.2lt) diesel engines found in the Land Rover, Ford, Peugeot and Citroën ranges.

COMPONENTS

REF	ART. NO.	OEM	DESCRIPTION
1	4880096	303-1277, 0188.M	Locking pin (8mm dia. 70 long)
2	4880061	303-1272, 0188.F	Flywheel locking tool-Ford
3	4880068	303-1270, 303-1059	Timing pin
4	4880080	0188AH	Centraliser spring - 1.4mm dia
5	4880106	0188F	Flywheel lock (zinc PL.)

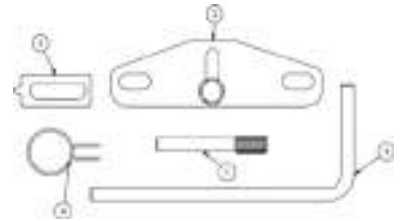

FORD



829042 - ENGINE TIMING KIT FORD DIESEL TDCI 2.2, 3.2

The 829042 kit has been developed specifically for the chain driven 2.2 common rail diesel engines fitted in the Ford Transit from around 2006 with the engine numbers Listed on our website. The 829042 is a 4 piece kit consisting of the components required to lock the crankshaft and cam sprockets in their timed position to allow the removal and replacement of the cam chain and associated components.

COMPONENTS

REF	ART. NO.	OEM	DESCRIPTION
1	4880091	6mm pin x2	Setting pin (chem. black) (6 X 60)
2	4880066	303-698 / 21-251	Timing pin
3	4880273	303-1587	Ford 2.2/2.3 global puma TDC setting tool assembly - previous

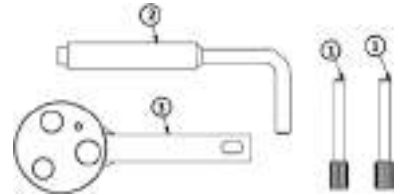

FORD



829043 - ENGINE TIMING KIT FORD DURATORQ (TDCI) BELT DRIVEN DIESEL - 1.4, 1.6, 1.8, 2.0

The 829043 kit has been developed specifically designed for the Ford 1.4lt, 1.6lt, 1.8lt and 2.0 belt driven diesel engines.

COMPONENTS

REF	ART. NO.	OEM	DESCRIPTION
1	4880050	303-376B	Camshaft alignment strap (chem. black)
2	4880070	21-104, 303-193	Setting pin
3	4880068	303-1059	Timing pin
4	4880096	303-735, 21-263	Locking pin (8mm dia. 70 long)
5	4880064	303-734, 21-262	Flywheel locking pin (12 x 55)
6	4880061	303-393, 21-168	Flywheel locking tool-Ford
7	4880062	303-393-01	Tooth block item 2
8	4880063	303-393-02	Short tooth block
9	4880090	303-732, 21-260	Setting pin 5.0mm (5 x 50)

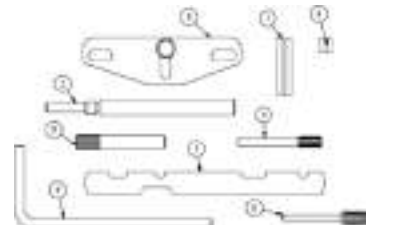

FORD



829044 - ENGINE TIMING KIT FORD/VOLVO PETROL - 1.25, 1.4, 1.6, 1.8, 2.0

The 829044 kit has been developed specifically for late Ford 1.25lt, 1.4lt, 1.6lt, petrol engines. Coverage also includes some 1.8lt, 2.0lt & 2.3lt engines

COMPONENTS

REF	ART. NO.	OEM	DESCRIPTION
1	4880049	21-163, 303-574	Crankshaft locking pin - Ford (chem. black)
2	4880051	21-210, 303-507	Mazda screw
3	4880052	21-259, 303-748	Setting pin (chem. black)
4	4880274	303-1054	Locking pin
5	4880050	303-376B	Camshaft alignment strap (chem. black)

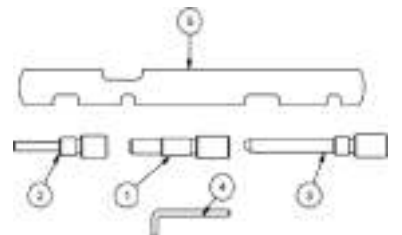

FORD



829045 - ENGINE TIMING KIT FORD PETROL 16V WITH VCT - 1.6

The 829045 has been developed to provide the essential tools required to set and time the main engine components when replacing the camshaft drive belts on the 1,25/1,4/1,5/1.6 16V petrol Ford Engines.

COMPONENTS

REF	ART. NO.	OEM	DESCRIPTION
1	4880274	303-1054	Locking pin
2	4880049	303-748	Crankshaft locking pin - Ford (chem. black)
3	4880069	303-1097	Camshaft sprocket locking tool 303-1097
4	4880050	303-376B	Camshaft alignment strap (chem. black)

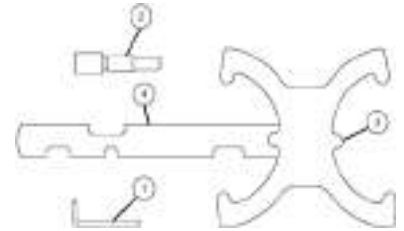

FORD

829046 - ENGINE TIMING KIT MAZDA, FORD PETROL - 1.8, 2.0, 2.3

The 829046 kit has been developed to allow the user to lock the cam and crankshaft in position to allow the removal and replacement of the timing chain fitted to the twin cam engines fitted to the Ford and Mazda ranges as listed on our website.

COMPONENTS

REF	ART. NO.	OEM	DESCRIPTION
1	4880267	49 UN30 310610, 303-1061	Machining detail for ford duratec camshaft alignment bracket
2	4880051	999 7152/49JE01 061, 303 507, 21-210	Mazda Screw
3	4880052	49N010 101/MOT 1430 303 620, 999 7201, 21-163	Setting pin (chem. black)
4	4880050	999 7151, 303 376, 49JE01 054, 303 367//21 162, 49UN30 3376	Camshaft alignment strap (chem. black)

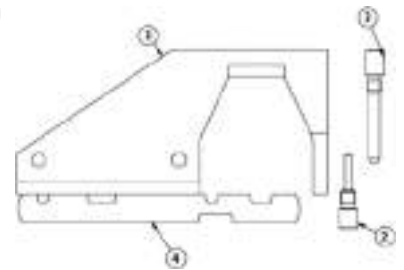

FORD

829047 - ENGINE TIMING KIT FORD SCTI ECOBOOST PETROL - 2.0

The 829047 kit has been developed specifically for the 2.0 direct injection chain driven petrol engines fitted with variable valve timing and found in both the Ford and Volvo ranges. 829047 is a 5 piece engine timing kit designed for the Ford 2.0 direct injection ecoboost petrol engines found in the Ford Focus, Mondeo and S-Max. Developed to allow the timing chain to be replaced whilst locking the crankshaft and camshafts in their correct timed positions. The 829047 also includes the crankshaft position sensor alignment tool.

COMPONENTS

REF	ART. NO.	OEM	DESCRIPTION
1	4880245	303-1565	Ford GTDI M14 Camshaft alignment tool assy
2	4880248		Dia. 2.0mm tensioner pin
3	4880278	303-1504	Ford 2.0 camshaft alignment tool
4	4880281	303-1521	Ford cranksaft sensor alignment tool (CKP)
5	4880049	303-748	Crankshaft locking pin - Ford (chem. black)

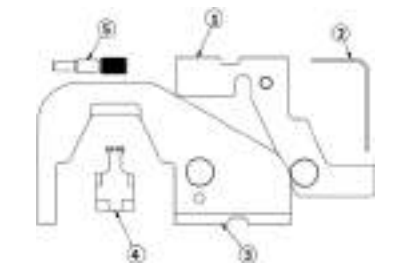

FORD

829048 - ENGINE TIMING KIT FORD, VOLVO SCTI ECOBOOST PETROL - 1.6

The 829048 kit has been developed specifically for the 1.6 direct injection petrol engines fitted with variable valve timing and found in both the Ford and Volvo ranges. 829048 is a 4 piece kit consisting of the components required to lock the crankshaft and cam pulleys in their timed position to allow the removal and replacement of the camshaft timing belt. The 829048 also includes the crankshaft front pulley alignment tool.

COMPONENTS

REF	ART. NO.	OEM	DESCRIPTION
1	4880249	303-1054	Dia. 3.0mm tensioner pin
2	4880270	303-1550, 999-7431	Ford 1.6 ecoboost crankshaft pulley alignment Tool assembly
3	4880049	303-748, 999-7406	Crankshaft locking pin - Ford (chem. black)
4	4880069	303-1097, 999-7429	Camshaft sprocket locking tool 303-1097

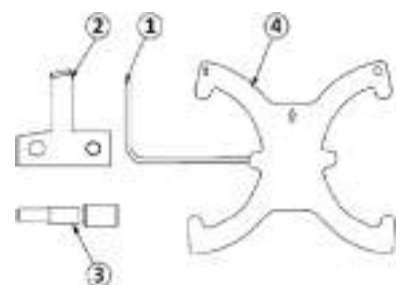

FORD

Sonic timing tools

829049 - ENGINE TIMING KIT FORD, PSA DIESEL TDCI, HDI - 1.4, 1.6

The 829049 kit has been developed specifically for the Ford 1.4 and 1.6 common rail diesel engines with the engine numbers listed on our website. The 829049 is a 4 piece kit consisting of the components required to lock the crankshaft and cam pulleys in their timed position to allow the removal and replacement of the cam belt and associated components.

FORD



COMPONENTS

REF	ART. NO.	OEM	DESCRIPTION
1	4880091	6mm pin x2	Setting pin (chem. black) (6 X 60)
2	4880066	303-698 / 21-251	Timing pin
3	4880273	303-1587	Ford 2.2/2.3 global puma TDC setting tool assembly

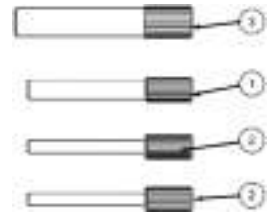

829050 - ENGINE TIMING & FUEL PUMP SETTING KIT FORD, LSV DIESEL - 2.0, 2.4

The 829050 kit has been developed specifically for the Ford/LDV/Jaguar 2.0lt, 2.2lt, 2.4lt and 3.2lt diesel engines.

FORD



COMPONENTS

REF	ART. NO.	OEM	DESCRIPTION
1	4880240	303-249-01	Fuel pump remover leg assembly
2	4880241	303-249-01	Center location plug for diesel pump remover
3	4880296	303-682	Ford engine front cover alignment tool 303-682
4	4880066	303-698	Timing pin
5	4880091	-	Setting pin (chem. black) (6 x 60)
6	4880279	303-705, 303-1093	Ford oil pump alignment tool- lasercut plated
7	4880014	303-249-01	Puller centre screw
8	4880013	303-249	Puller beam
9	4880331	-	M8 x 55LG 1.25P - zinc - set screw
10	4880191	303-679	Fuel pump cover tool body
11	4880047	-	Washer M8 zinc plated
12	4880065	303-675	Flywheel locking pin
13	4880064	303-734	Flywheel locking pin (12 x 55)
14	4880090	303-732	Setting pin 5.0mm (5 x 50)
15	4880096	303-735	Locking pin (8mm dia. 70 long)
16	4880144	-	Tensioner locking pin 1.4mm bzp & clear passivate
17	4880190	303-1151	303-1151 Locking tool
18	4880273	303-1587	Ford 2.2/2.3 global puma TDC setting tool assembly - previous

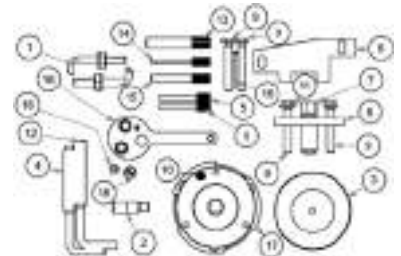

829051 - ENGINE TIMING KIT FORD PETROL GTDI ECOBOOST - 1.0

Specifically designed for the new Ford 1.0lt 3 cylinder ecoboost engines. The 829051 kit offers the timing tools required for replacement of the oil bathed camshaft drive belt on these engines.

Note: Where the VCT pulleys require removing or setting the additional kit part number 829050 will be required.

FORD



COMPONENTS

REF	ART. NO.	OEM	DESCRIPTION
1	4880253	303-1604	Ford 1.0I - GTDI cranksaft timing pin
2	4880254	303-1602	Large tooth block version of MM 23060 10 - OEM 303.1602
3	4880274	303-1054	Locking pin
4	4880096	8mm tensioner pin	Locking pin (8mm dia. 70 long)
5	4880242	303-1605/1	Assembly details for 303-1605/1 camshaft locking tool
6	4880243	303-1606/2	Assembly details for 303-1605/2 camshaft locking tool
7	4880238	303-1603	Ford oil seal installer
8	4880121	4mm tensioner pin	Auxiliary belt tensioner locking pin
9	4880084	303-732	DTI extension item 3

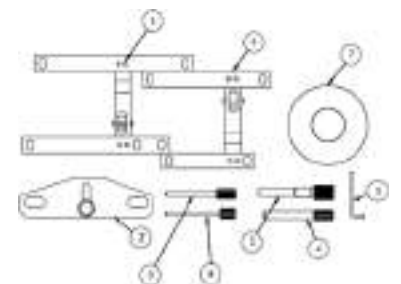

829052 - VARIABLE VALVE SETTING KIT FORD PETROL VCT ECOBOOST - 1.0

Specifically designed for the new Ford 1.0lt 3 cylinder ecoboost engines, and used in conjunction with 829051 to assemble the VCT (Variable Camshaft Timing) units on the camshafts in their TDC position without play. Required to align the VCT units when they are assembled on the camshafts.

COMPONENTS

REF	ART. NO.	OEM	DESCRIPTION
1	4880246	303-1606-1	Variable camshaft timing locking tool assembly - inlet 303-1
2	4880247	303-1606 -2	Variable camshaft timing locking tool assembly - exhaust T 30

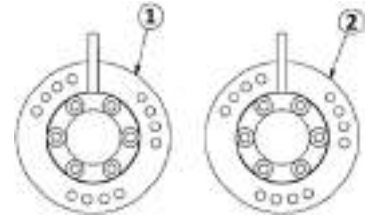
FORD
829063 - ENGINE TIMING KIT OPEL/FIAT/FORD/PSA DIESEL JTD/HDI - 1.3

This is an essential engine timing tool set that provides the camshaft and crankshaft timing tools only.

COMPONENTS

REF	ART. NO.	OEM	DESCRIPTION
1	4880183	104-A, EN 46781	Camshaft alignment tool assy
2	4880186	-	Crankshaft pin assy
3	4880096	EN-46785	Locking pin (8mm dia. 70 long)

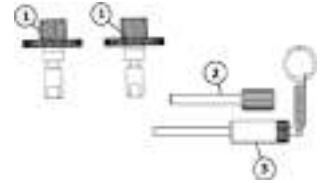
FORD
829088 - CAMSHAFT HOLDING TOOL FIAT/FORD/OPEL DIESEL JTD - 1.3

The 829088 camshaft pulley holding tool has been designed to allow the user to loosen and tighten the camshaft pulley fixings without moving the camshafts or causing damage to any timing tools that may be fitted. Conveniently designed to allow the use of a 1/2 drive wrench the 829088 combines the double headed OEM tool into one single tool.

COMPONENTS

REF	ART. NO.	OEM	DESCRIPTION
1	829088	1 871 008 600 303-1475	Camshaft holding tool Fiat/Ford/Opel diesel JTD - 1,3

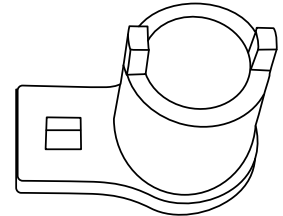
FORD
829089 - CAMSHAFT SETTING TOOL VOLVO/FORD

The 829089 is designed to hold the front crankshaft pulley while tightening or loosening the pulley fixings across the Volvo range of engines and the Ford 2.5 petrol engine found in the ST Focus etc.

COMPONENTS

REF	ART. NO.	OEM	DESCRIPTION
1	829089	999 5433, 303-1179	Crankshaft holding tool Volvo/Ford



FORD
829094 - TIMING CHAIN TENSIONER LEVER FORD PETROL, DIESEL

The 829094 flywheel locking kit is equivalent to the Ford OEM flywheel locking kit as detailed below. It is used to lock the flywheel to allow front pulleys etc. to be loosened and tightened without turning the engine.

N.B: Starter motor must first be removed.

COMPONENTS

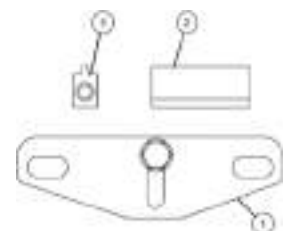
REF	ART. NO.	OEM	DESCRIPTION
1	4880061	21-168 A, 303-393A	Flywheel locking tool-Ford
2	4880062	303-393-02	Tooth block item 2
3	4880063	303-393-01	Short tooth block

FORD

Sonic timing tools

829095 - HIGH PRESSURE FUEL PUMP PULLER DIESEL FORD - TDCI - TRANSIT 2.2

FORD

As of 2011 Ford changed the method of fuel pump sprocket removal on the 2.2 TDCI (Puma) diesel engines. The sprocket no longer has threaded holes which means the legs of the puller used to remove the sprocket must be hooked in shape. The K00286 puller allows the removal of these sprockets by allowing the high pressure diesel injection pump to be pushed out of the pump sprocket to enable pump removal without disturbing the timing chain. Special note: To perform this task the 829095 must be used with Ford special tool 303-1151 (sprocket holding tool).



Note: The 829095 kit contains a force screw. Force screws must be lubricated with high pressure grease. Sonic recommends the use of molybdenum disulphide grease (drive shaft grease). Do not use assembly or anti-seize greases (copper greases).

Equivalent to OEM 303-249, 303-249-01

COMPONENTS

REF	ART. NO.	OEM	DESCRIPTION
1	4880240	303-249-01	Fuel pump remover leg assembly
2	4880241	303-249-01	Center location plug for diesel pump remover
3	4880013	303-249	Puller beam
4	4880014	303-249-01	Puller centre screw
5	4880219	303-249	M8 x 50 cap head
6	4880047	999 5382	Washer M8 zinc plated

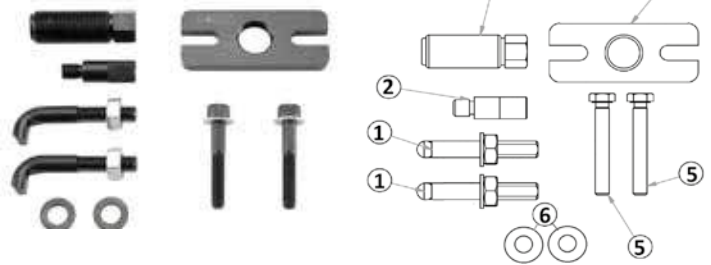

829106 - CAM BELT TENSIONER WRENCH VAG ADJUSTABLE HEAD

FORD

The 829106 is an adjustable cam-belt tensioner tool. Equivalent to EOM T10020 and Matra V159.



COMPONENTS

REF	ART. NO.	OEM	DESCRIPTION
1	829100	T10020//Matra V159	Cam belt tensioner wrench vag adjustable head



NOTE : l'utilisation de ce kit nécessite l'acquisition d'outils supplémentaires.

829107 - OIL PUMP ALIGNMENT PLATE FORD, JAGUAR, LAND ROVER, ROVER, PSA DURATORQ DIESEL 2.0, 2.2, 2.4, 3.2

FORD

The 829107 oil pump alignment tool has been developed to allow the user to correctly align the engine oil pump in the sump after an engine rebuild etc. It is important that the pump be correctly and accurately aligned to ensure the oil pump sprocket is not operating with excessive side loads.



COMPONENTS

REF	ART. NO.	OEM	DESCRIPTION
A	829107	303-705, 303-1093, 0198.H	Oil pump alignment plate Ford/Jaguar Land Rover/PSA diesel

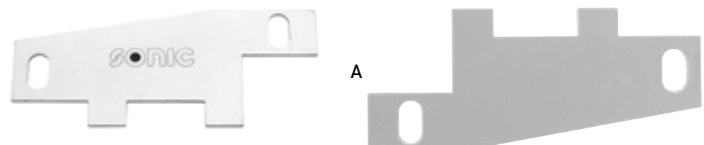

NOTE : l'utilisation de ce kit nécessite l'acquisition d'outils supplémentaires.

829135 - FORD CAMBELT TIMING KIT FORD 1.0 GTDI

FORD

Developed to lock the engines of the vehicles listed in their "timed" position so that the cambelt can be safely removed and replaced. Please note: where the VCT pulleys require removing or setting an additional kit will also be required.



COMPONENTS

REF	ART. NO.	OEM	DESCRIPTION
A	4880254	303-1602	Large tooth block version of mm 23060 10 - O.E.M 303.1602
B	4880253	303-1604	Ford 1.0I - GTDI cranksaft timing pin
C	4880274	303-1054	Locking pin
D	4880096	303-732	Locking pin (8mm dia. 70 Long)
E	4880367	303-1605/2	Camshaft setting block exhaust
F	4880366	303-1605/1	Camshaft locking block inlet
G	4880238	303-1603	Ford oil seal installer
H	4880090	4mm pin	Setting pin 5.0mm (5 x 50)
I	4880121	8mm pin	Auxiliary belt tensioner locking pin
J	4880216	-	M6x30 cap head screw

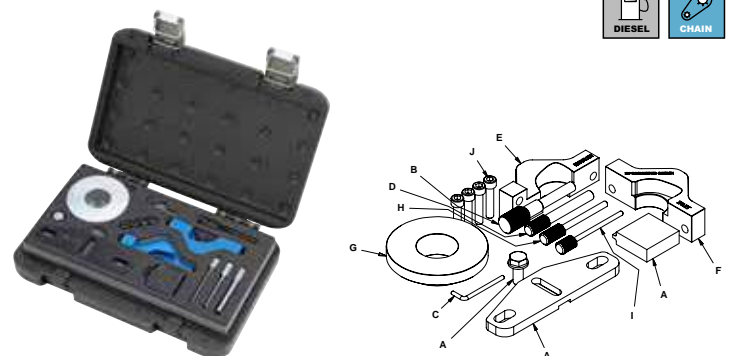

829053 - ENGINE TIMING KIT HONDA PETROL SOHC/DOHC - 1.6, 1.8, 2.0, 2.2, 2.3, 3.0
HONDA

The 829053 has been designed to offer not only the special tools listed by Honda for the applications listed but also the correctly sized M6 bolt that is required to lock the sprung loaded cam belt tensioners found on many of the listed applications.

COMPONENTS

REF	ART. NO.	OEM	DESCRIPTION
1	4880236	14540-P13-003	Tension locking tool for Honda 87 onwards
2	4880001	07LAG-PT20100 / 18G1671	Balancer shaft locking screw - Rover/Honda
3	4880090	07744-0010400	Setting pin 5.0mm (5 x 50)
4	4880073	-	HT setscrew M6 x 45 Zc.PL.

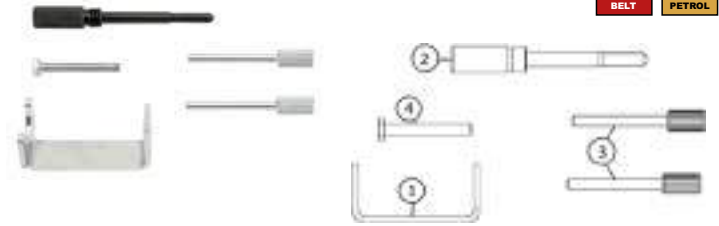
829018 - ENGINE TIMING KIT FIAT, PSA, IVECO JTD DIESEL - 2.8
IVECO

The 829018 has been developed for Fiat 2.8 diesel engines that are found in the Fiat, Iveco and PSA van ranges. This kit provides all the tools required to set the timed components when replacing the timing belt. The kit also includes the components require to lock the flywheel when undoing and tightening up the front pulley fixings as well as the special spacer to hold the belt tensioner in its fully retracted position.

COMPONENTS

REF	ART. NO.	OEM	DESCRIPTION
1	4880237	1 870 765 001	Flywheel locking piece (Fiat)
2	4880090	1 860 617 000	Setting pin 5.0mm (5 x 50)
3	4880097	8mm pin	Locking pin (8mm dia. x 60 long)
4	4880132	1 860 638 000	Tensioning tool

08
829026 - ENGINE TIMING KIT FIAT, PSA, OPEL, IVECO JTD DIESEL - 2.5
IVECO

The 829026 is a small diesel locking kit specifically assembled to cover the 2.5/2.8 belt driven diesel engines found in the Citroën, Peugeot, Renault and Fiat ranges.

COMPONENTS

REF	ART. NO.	OEM	DESCRIPTION
1	4880132	1 860 638 000	Tensioning tool
2	4880095	1 870 667 000, 1 870 765 001	Locking pin (zinc pl.)
3	4880090	1 860 617 000	Setting pin 5.0mm (5 X 50)

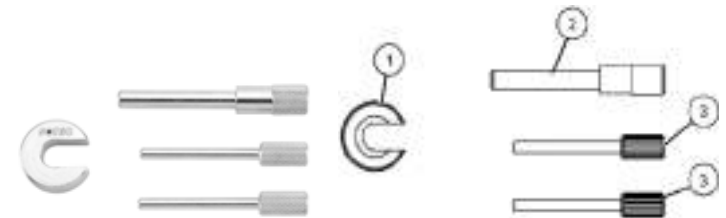
829037 - ENGINE TIMING KIT JAGUAR LAND ROVER DIESEL TDV6 - 2.7
JAGUAR

The 829037 engine timing kit allows the valve timing to be set and maintained during cam belt replacement on the popular Jaguar/Land Rover TDV6 diesel engine found across the Jaguar & Land Rover ranges. The 829037 also includes the additional PSA locking tools required for the 2.7 HDI engine found in the Citroën and Peugeot ranges.

COMPONENTS

REF	ART. NO.	OEM	DESCRIPTION
1	4880127	303-1132	Camshaft sprocket timing pin
2	4880079	303-1126	Camshaft sprocket timing pin
3	4880129	303-1116	Fly wheel locking tool
4	4880128	303-1117	Fly wheel locking tool 2
5	4880077	0195-K	Flywheel locking pin Peugeot 0195-K
6	4880078	0195-C	Coolant pump pulley pin Peugeot 0195-C



Sonic timing tools

829040 - ENGINE TIMING KIT JAGUAR LAND ROVER, FORD, PSA DIESEL DW12 - 2.2

The 829040 is a compact tool set which includes the camshaft sprocket, flywheel locking tools and flywheel timing pin required when setting the valve timing and/or changing the timing belt on DW12 (2,2lt) diesel engines found in the Land Rover, Ford, Peugeot and Citroën ranges.

COMPONENTS

REF	ART. NO.	OEM	DESCRIPTION
1	4880096	303-1277, 0188.M	Locking pin (8mm dia. 70 long)
2	4880061	303-1272, 0188.F	Flywheel locking tool-Ford
3	4880068	303-1270, 303-1059	Timing pin
4	4880080	0188AH	Centraliser spring - 1.4mm dia
5	4880106	0188F	Flywheel lock (zinc PL.)

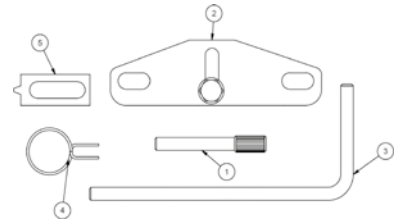

JAGUAR



829107 - OIL PUMP ALIGNMENT PLATE FORD, JAGUAR, LAND ROVER, ROVER, PSA DURATORQ DIESEL 2.0, 2.2, 2.4, 3.2

The 829107 oil pump alignment tool has been developed to allow the user to correctly align the engine oil pump in the sump after an engine rebuild etc. it is important that the pump be correctly and accurately aligned to ensure the oil pump sprocket is not operating with excessive side loads.

COMPONENTS

REF	ART. NO.	OEM	DESCRIPTION
A	829107	303-705, 303-1093, 0198.H	Oil pump alignment plate Ford/Jaguar Land Rover/PSA diesel

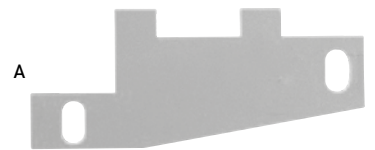

NOTE : l'utilisation de ce kit nécessite l'acquisition d'outils supplémentaires.

JAGUAR



829126 - ENGINE TIMING KIT - JLR 2.0 GTDI

A comprehensive engine timing tool kit for the Jaguar, Land Rover 2.0 Petrol GTDI (Gasoline Turbo Direct Injection) engines.

COMPONENTS

REF	ART. NO.	OEM	DESCRIPTION
A	4880278	303-1600, 303-1565	Ford 2.0 camshaft alignment tool
B	4880390	303-1595	Crankshaft alignment tool plate with guides and pins
C	4880389	303-1595	Threaded bush guide 16 x 56mm
D	4880391	303-1595	Threaded pin 6 x 61
E	4880281	303-1521	Ford cranksaft sensor alignment tool (CKP)
F	4880392	303-1594	Flywheel locking tool
G	4880049	303-748	Crankshaft locking pin - Ford (chem. black)

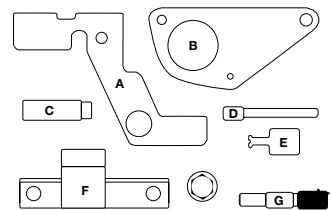

JAGUAR



829083 - ENGINE TIMING KIT CHRYSLER/LDV DIESEL CRD - 2.5, 2.8

The 829083 kit was developed for the Chrysler DOHC common rail diesel engine found in the Voyager, Grand Voyager and the LDV Maxus van. The 829083 kit allows the user to replace the timing belt whilst maintaining the correct timed position of the camshafts and crankshaft.

COMPONENTS

REF	ART. NO.	OEM	DESCRIPTION
1	4880222	VM.1089, LDV196	Chrysler 2.5/2.8 CRD timing pin - VM.1089
2	4880223	VM.1068, LDV196	Timing pin (chrysler 2.5/2.8 CRD VM.1068)
3	4880224	VM.1052, LDV192	Timing pin (chrysler 2.5/2.8 CRD VM.1052)
4	4880225	VM.1053, LDV193	Timing pin (chrysler 2.5/2.8 CRD VM.1053)
5	4880226	VM1074	Timing belt retaining spring (VM.1074)
6	4880015	VM.9660, H2587	Tension wrench
7	4880282	VM.1080	Chrysler timing pin (VM.1080)
8	4880283	VM.8873	Chrysler timing pin (VM.8873)

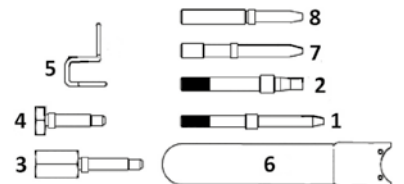

JEEP



829084 - ENGINE TIMING KIT CHRYSLER/JEEP DIESEL CRD - 2.8
JEEP

The 829084 kit has been developed specifically for the 2008 and later 2.8 CRD Chrysler/Jeep engines where the cam belt drives one camshaft and the second camshaft is driven via gears. The 829084 kit is a 2 piece kit consisting of the components required to lock the crankshaft and camshafts in their timed position to allow the removal and replacement of the cam belt and associated components.

COMPONENTS

REF	ART. NO.	OEM	COMPONENTS
1	4880284	VM.9992	Chrysler crankshaft locking tool [VM.9992]
2	4880285	VM.9991	Chrysler exhaust camshaft locking tool [VM.9991]

829085 - ENGINE TIMING KIT CHRYSLER/JEEP DIESEL CRD - 3.0
JEEP

The 829085 kit has been designed for the Jeep 3.0 lt V6 diesel engine found in the late model (2011 on) Jeep Grand Cherokee. The 829085 provides all the cam and crankshaft locking tools required for chain replacement.

COMPONENTS

REF	ART. NO.	OEM	DESCRIPTION
1	4880311	VM10338-1	Camshaft locking tool RH - assy
2	4880310	VM10338-2	Camshaft locking tool LH - assy
3	-	-	Cap head screws for reference 1
4	4880313	VM10359a	Crankshaft timing pin assy
5	4880312	VM10339	Tensioner locking pin

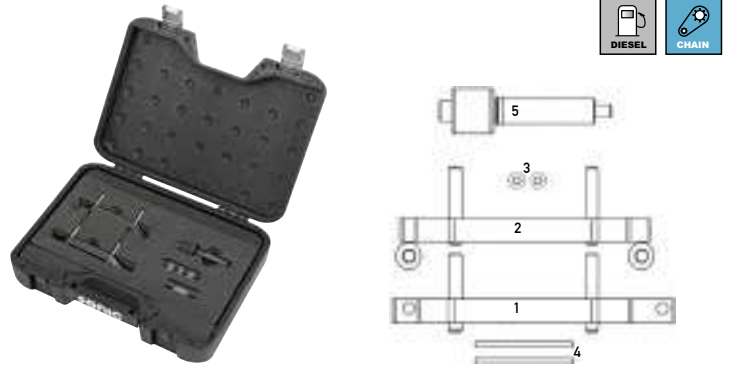
08
829087 - ENGINE/BALANCE SHAFT TIMING KIT MERCEDES-BENZ DIESEL (651) - 1.8, 2.1
JEEP

The 829087 has been specifically designed for Mercedes-Benz vehicles fitted with the chain driven 1.8/2.1 CDI diesel engines (engine code pre fix 651). These engines are found across the Mercedes-Benz range including A, B, C, E, G and S class as well as the Sprinter and Vito vans from as early as 2007 up to 2015. These engines are also found in the Jeep and Dodge ranges. The 829087 contains the essential alignment tools to align the camshafts, crankshaft and balance shafts in one compact kit.

COMPONENTS

REF	ART. NO.	OEM	DESCRIPTION
1	4880316	651 589 01 40 00	Camshaft alignment tool
2	4880315	651 589 00 40 00	Crankshaft holding/turning tool
3/4/5/6	4880314	651 589 02 63 00	Balance shaft lock tool assy

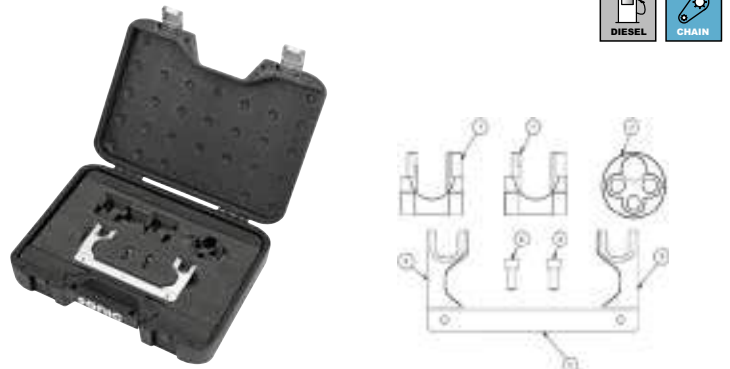
829046 - ENGINE TIMING KIT MAZDA, FORD PETROL - 1.8, 2.0, 2.3
MAZDA

The 829046 kit has been developed to allow the user to lock the cam and crankshaft in position to allow the removal and replacement of the timing chain fitted to the twin cam engines fitted to the Ford and Mazda ranges as listed on our website.

COMPONENTS

REF	ART. NO.	OEM	DESCRIPTION
1	4880267	49 UN30 310610, 303-1061	Machining detail for ford duratec camshaft alignment bracket
2	4880051	999 7152/49JE01 061, 303 507, 21-210	Mazda Screw
3	4880052	49N010 101/MOT 1430 303 620, 999 7201, 21-163	Setting pin (chem. black)
4	4880050	999 7151, 303 376, 49JE01 054, 303 367//21 162, 49UN30 3376	Camshaft alignment strap (chem. black)



Sonic timing tools

829086 - ENGINE TIMING KIT MERCEDES-BENZ/CHRYSLER CRD - 2.2, 2.7

The 829086 covers a large range of vehicles fitted with chain driven engines from Mercedes-Benz including the PT Cruiser 2.2 CRD and Jeep Grand Cherokee 2.7 CRD from Chrysler.

COMPONENTS

REF	ART. NO.	OEM	DESCRIPTION
1	4880203	602 589 00 40 00 8929	Flywheel locking tool
2	4880206	602 589 00 40 00 8929	Camshaft locking pin assy
3	4880205	601 589 02 40 00 8933	Flywheel locking tool Mercedes-Benz 602 589 00 40 00
4			Bolts for reference 3

MERCEDES

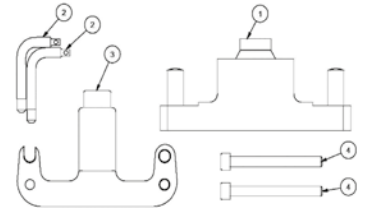

829087 - ENGINE/BALANCE SHAFT TIMING KIT MERCEDES-BENZ DIESEL (651) - 1.8, 2.1

The 829087 has been specifically designed for Mercedes-Benz vehicles fitted with the chain driven 1.8/2.1 CDI diesel engines (engine code pre fix 651). These engines are found across the Mercedes-Benz range including A, B, C, E, G and S class as well as the Sprinter and Vito vans from as early as 2007 up to 2015. These engines are also found in the Jeep and Dodge ranges. The 829087 contains the essential alignment tools to align the camshafts, crankshaft and balance shafts in one compact kit.

COMPONENTS

REF	ART. NO.	OEM	DESCRIPTION
1	4880316	651 589 01 40 00	Camshaft alignment tool
2	4880315	651 589 00 40 00	Crankshaft holding/turning tool
3/4/5/6	4880314	651 589 02 63 00	Balance shaft lock tool assy

MERCEDES

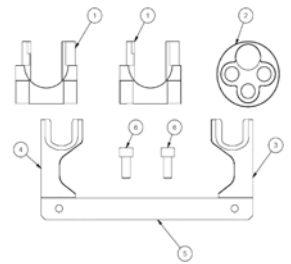
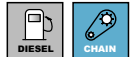

829120 - CAMSHAFT VALVE TIMING KIT - MERCEDES BENZ 1,8/2,1/2,2

Specifically designed for the Mercedes-Benz vehicles fitted with the chain driven 1.8 | 2.1 CDI diesel engines (engine code pre fix 651). The specially designed cam locking tool can be used on both early and late versions of the 651 Mercedes-Benz engine. These engines are found across the Mercedes-Benz range including as well as in the Jeep and Dodge ranges. NOTE: 829120 supersedes Sonic Equipment kit 829087.

COMPONENTS

REF	ART. NO.	OEM	DESCRIPTION
1	4880385	651 589 09 40 00, 651 589 01 40 00	Camshaft locking tool + bolts
2	4880315	651 589 01 40 00	Crankshaft holding/turning tool
3	4880314	651 158 90 26 300	Balance shaft lock tool assy
4	4880314	651 158 90 26 300	Balance shaft lock tool assy
5	4880314	651 158 90 26 300	Balance shaft lock tool assy

MERCEDES

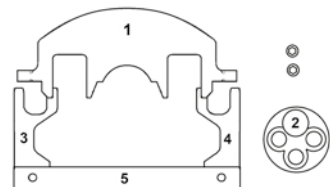
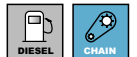

829124 - TIMING CHAIN FITTING BRIDGE - MERCEDES BENZ

The Mercedes-Benz M651 1.8 | 2.1 diesel engines can suffer from issues requiring the replacement of the timing chain. The M651 timing chain is at the back of the engine (flywheel end) which makes the replacement of the timing chain difficult. To avoid the need for completely stripping the engine the new chain must be attached to the old chain and "threaded" around the engine sprockets while turning the crankshaft. The 829124 Timing Chain Fitting Bridge helps guide the new chain into position while the old chain is extracted by maintaining the contact of the new chain with the sprocket. Note: the 829124 must be used with the cam locking tools found in 829120 M651 engine timing kits.

COMPONENTS

REF	ART. NO.	OEM	DESCRIPTION
1	829214	651 587 03 04 00	Timing Chain Fitting Bridge - Mercedes Benz

MERCEDES

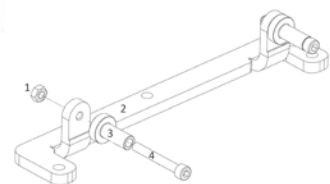
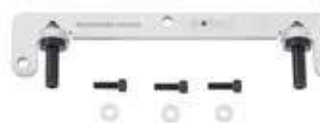
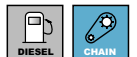

829134 - ENGINE TIMING KIT - RENAULT/NISSAN/MERCEDES/VAUXHALL 1,6D
MERCEDES

829134 has been developed specifically for the 1.6 R9M diesel engines fitted across the Renault, Nissan, Vauxhall/Opel and Mercedes-Benz ranges as listed. The 829134 contains all the essential tools required to lock the engine in its "timed" position for safe removal and replacement of the camshaft drive chain.

COMPONENTS

REF	ART. NO.	OEM	DESCRIPTION
1	4880359	626 589 04 40 00, MOT 1969	Camshaft alignment tool
2	4880118	626 589 02 40 00, MOT 1770 EN956-1, EN48334	Crankshaft pulley holding tool
3	4880201	-	Locking pin
4	4880121	KM 6130	Auxiliary belt tensioner locking pin
5	4880293	629 589 00 15 00, MOT 1970	Crankshaft timing pin Renault OEM MOT1970

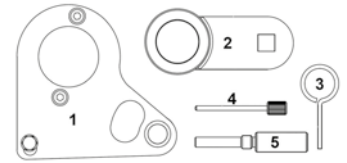
829054 - ENGINE TIMING KIT RENAULT/NISSAN PETROL (K4) - 1.6, 2.0
NISSAN

The 829054 offers the essential engine timing tools required for the Renault petrol 16V belt driven 1.6L and 2.0L engines. The 829054 kit of four tools enables the correct engine timing to be performed on Renault K4J, K4M & F4P, F4R engines, when changing the timing belt. The set includes 2 crankshaft timing pins and camshaft setting bar with the bracket specifically for the K4M 813 engine from 2003 onwards.

COMPONENTS

REF	ART. NO.	OEM	DESCRIPTION
1	4880048	MOT 1489	Crankshaft locking pin (chem. black)
2	4880095	MOT 1054	Locking pin (zinc PL.)
3	4880109	MOT 1496	Camshaft setting bar - Renault
4	4880111	MOT 1750	Mounting bracket (MOT 1759)

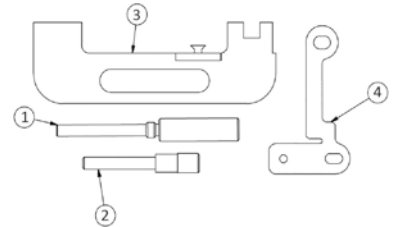
08
829055 - ENGINE TIMING KIT RENAULT/OPEL/NISSAN DIESEL (BELT DRIVE) - 1.5, 1.9, 2.2, 2.3, 2.5
NISSAN

The 829055 offers the essential engine timing tools required for the Renault belt driven DCI range of diesel engines. It includes the tools required for 1.5, 1.9, 2.2, 2.3 and 2.5 DCI diesel engines found in the Dacia, Nissan, Renault, Suzuki and Opel/Vauxhall ranges.

COMPONENTS

REF	ART. NO.	OEM	DESCRIPTION
1	4880048	MOT 1489	Crankshaft locking pin (chem. black)
2	4880047	-	Washer M8 zinc plated
3	4880073	-	Ht setscrew M6 x 45 Zc.PL.
4	4880095	MOT 1054	Locking pin (zinc PL.)
5	4880096	MOT 1430	Locking pin (8mm dia. 70 long)
6	4880116	MOT 1543	Tensioning tool - Renault 19 DCI
7	4880174	MOT 1538	High pressure pump pin C/W T/bar
8	4880175	MOT 1536 KM6203	Crankshaft timing pin (7 x 80)
9	4880177	-	H.T. Setscrew M8x60 zinc plate
10	4880178	MOT 1534 KM6205	Inlet cam setting tool (chem. black)
11	4880176	MOT 1537 KM6205	Exhaust cam setting tool

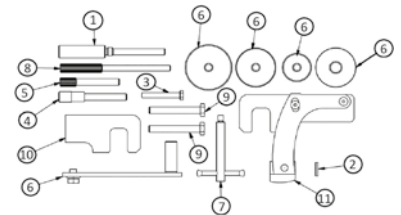

Sonic timing tools

829056 - ENGINE TIMING KIT RENAULT/OPEL/NISSAN DIESEL (CHAIN DRIVE) - 1.6, 2.0, 2.3

The 829056 has been specifically put together to allow the user to lock the engine components of the 1.6, 2.0 and 2.3 Renault engines used across the Renault, Opel and Nissan ranges. The 829056 kit includes the essential tools required to allow the removal and replacement of the engine timing chain.

NISSAN



COMPONENTS

REF	ART. NO.	OEM	DESCRIPTION
1	4880122	MOT 1766, EN48330	Crankshaft locking pin
2	4880119	MOT 1769, EN48332, MOT 1969 (1,6L)	Camshaft setting tool (MOT 1769)
3	4880121	KM 6130	Auxiliary belt tensioner locking pin
4	4880118	MOT 1770, KM 956-1, EN-48334	Crankshaft pulley holding tool
5	4880120	MOT 1773, EN48331	Camshaft gear alignment tool
6	4880201	-	Locking pin
7	4880210	-	4mm hex key
8	4880330	-	M6 x 40 HT setscrew
9	4880293	MOT 1970	Crankshaft timing pin Renault OEM MOT1970
10		MOT 1969	For 1.6l engines (R9M)
11		MOT 1769	For 2.0l/2.3l engines (M9R/M9T)

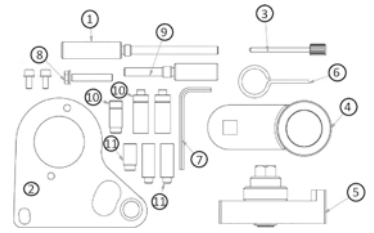

829130 - FLYWHEEL/FRONT PULLEY LOCKING TOOL SET - RENAULT/NISSAN

The 829130 has been developed to provide a locking solution for the flywheel and front pulley on the Renault engines listed below. The kit also provides the primary tools required for timing chain replacement on the Renault twin cam 1.4, 1.6, 2.0, 2.5 and 3.5 litre petrol engines.

NISSAN



COMPONENTS

REF	ART. NO.	OEM	DESCRIPTION
1	4880403	MOT 919-02	Flywheel locking tool - assy
2	4880402	MOT.1431	Flywheel locking tool - assy
3	4880414	MOT 1716	Cover/sump/joint separator tool
4	4880401	MOT 2019 / MOT 1789	Crankshaft pulley holding tool

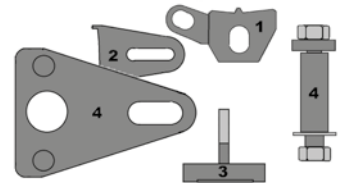

829134 - ENGINE TIMING KIT - RENAULT/NISSAN/MERCEDES/VAUXHALL 1,6D

829134 has been developed specifically for the 1.6 R9M diesel engines fitted across the Renault, Nissan, Vauxhall/Opel and Mercedes-Benz ranges as listed. The 829134 contains all the essential tools required to lock the engine in its "timed" position for safe removal and replacement of the camshaft drive chain.

NISSAN



COMPONENTS

REF	ART. NO.	OEM	DESCRIPTION
1	4880359	626 589 04 40 00, MOT 1969	Camshaft alignment tool
2	4880118	626 589 02 40 00, MOT 1770 EN956-1, EN48334	Crankshaft pulley holding tool
3	4880201	-	Locking pin
4	4880121	KM 6130	Auxiliary belt tensioner locking pin
5	4880293	629 589 00 15 00, MOT 1970	Crankshaft timing pin Renault OEM MOT1970

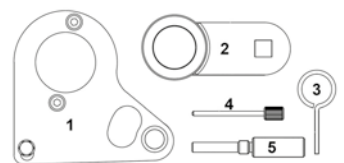

829015 - ENGINE TIMING KIT FIAT, OPEL, SAAB JTD DIESEL - 1.6, 1.9, 2.0, 2.4

The 829015 engine timing kit has been put together to provide the essential crankshaft and cam shaft timing pins only for the Fiat/Opel JTD diesel engines found across the Fiat, Opel, Saab ranges.

OPEL



COMPONENTS

REF	ART. NO.	OEM	DESCRIPTION
1	4880188	1.870.896.900, EN-46789, 32 025 008	Camshaft alignment tool
2	4880136	1.860.898.000	Flywheel locking tool
3	4880137	-	Stud assy
4	4880218	-	M8 x 20mm socket head screw
5	4880091	1.860.965.000	Setting pin (chem. black) [6 X 60]
6	4880187	1.860.905.000, 1.860.905.010, 2.000.003.000, EN-46788, 32 025 009	Crankshaft alignment tool

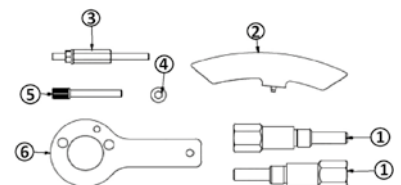

829016 - ENGINE TIMING & REBUILD SET FIAT, OPEL, FORD, PSA JTD DIESEL - 1.3

The 829016 has been developed to allow the user to change the cam chain on the later 1.3 JTD/CDTi & HDi diesel engines found in the PSA, Fiat, Ford, Suzuki and Opel ranges.

COMPONENTS

REF	ART. NO.	OEM	DESCRIPTION
1	4880200	1 871 000 200, 303-1469, KM-662-C	Crankshaft pulley flange holding tool
2	4880004	1 870 900 400	Timing chain tensioning tool
3	4880005	0104-C, 1 870 900 300, 303-1468	Crankshaft alignment tool
4	4880183	0104-A, 1 871 000 900, 1 860 985 000, EN 46781, 09917-68610	Camshaft alignment tool assy
5	4880186	EN 46785, 09912-38300	Crankshaft pin assy
6	4880096	Fiat 8mm pin	Locking pin (8mm dia. 70 long)

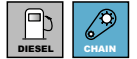
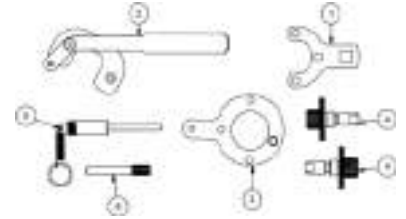
OPEL
829017 - ENGINE TIMING KIT OPEL, CHEVROLET, FIAT PETROL - 1.6, 1.8 16V

The 829017 has been developed to allow the user to change the cam belt on the later Z and A coded GM Petrol belt driven engines. These engines are also found in Fiat and Alfa Romeo vehicles as listed below.

COMPONENTS

REF	ART. NO.	OEM	DESCRIPTION
1	4880234	KM-6625	Flywheel holding tool (KM-6625)
2	4880168	KM-911	Flywheel locking tool item 2
3	4880185	KM6130, KM6349	Auxilliary drive belt tensioner locking pin (4 x 55)
4	4880239	KM-6628A, 2 000 012 000	Camshaft locking tool (GM)
5	4880057	KM-6340, 2 000 012 100	Cam locking tool (pair)
6	4880058	KM-6333	Locking pin

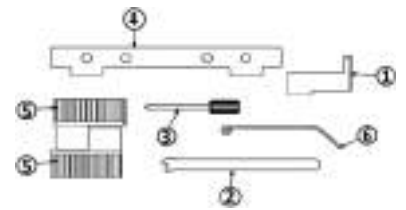
OPEL
829022 - TWIN CAMSHAFT LOCKING TOOL OPEL, FIAT PETROL - 2.2

The 829020 has been developed to lock the cam and crankshaft in position to allow the removal and replacement of the timing belt fitted to the current generation 1.4 Fiat MultiAir engines.

COMPONENTS

REF	ART. NO.	OEM	DESCRIPTION
1	4880179	KM 6148	Camshaft locking tool (assembled)
2	4880180	KM 6077	Tension pin 1.0

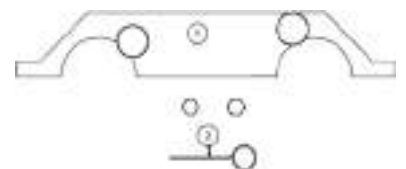
OPEL
829026 - ENGINE TIMING KIT FIAT, PSA, OPEL, IVECO JTD DIESEL - 2.5

The 829026 is a small diesel locking kit specifically assembled to cover the 2.5/2.8 belt driven diesel engines found in the Citroën, Peugeot, Renault and Fiat ranges.

COMPONENTS

REF	ART. NO.	OEM	DESCRIPTION
1	4880132	1 860 638 000	Tensioning tool
2	4880095	1 870 667 000, 1 870 765 001	Locking pin (zinc pl.)
3	4880090	1 860 617 000	Setting pin 5.0mm (5 X 50)

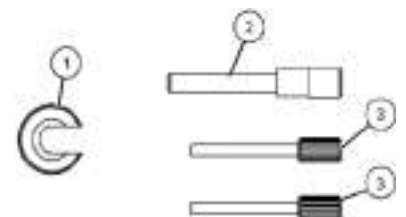
OPEL
08

Sonic timing tools

829039 - ENGINE TIMING KIT FIAT, OPEL, FORD, PSA JTD DIESEL - 1.3

The 829039 engine timing kit allows the valve timing to be set on the current 1,3 Multijet Fiat derived diesel engines found across the Fiat, Ford, Opel & PSA ranges.

COMPONENTS

REF	ART. NO.	OEM	DESCRIPTION
1	4880135	153A	Flywheel holding tool
2	4880183	21 860 985 000, EN 46781, 303-1472, 0104-A	Camshaft alignment tool assy.
3	4880005	1 870 900 300, 303-1468, 0104-C	Crankshaft alignment tool
4	4880280	303-1475, 1 871 008 600	Ford 1.3 diesel camshaft support tool Ø36 ID

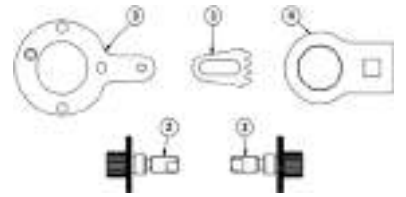

OPEL

829055 - ENGINE TIMING KIT RENAULT/OPEL/NISSAN DIESEL (BELT DRIVE) - 1.5, 1.9, 2.2, 2.3, 2.5

The 829055 offers the essential engine timing tools required for the Renault belt driven DCI range of diesel engines. It includes the tools required for 1.5, 1.9, 2.2, 2.3 and 2.5 DCi diesel engines found in the Dacia, Nissan, Renault, Suzuki and Opel/Vauxhall ranges.

COMPONENTS

REF	ART. NO.	OEM	DESCRIPTION
1	4880048	MOT 1489	Crankshaft locking pin (chem. black)
2	4880047	-	Washer M8 zinc plated
3	4880073	-	Ht setscrew M6 x 45 Zc.PL.
4	4880095	MOT 1054	Locking pin (zinc PL.)
5	4880096	MOT 1430	Locking pin (8mm dia. 70 long)
6	4880116	MOT 1543	Tensioning tool - Renault 19 DCI
7	4880174	MOT 1538	High pressure pump pin C/W T/bar
8	4880175	MOT 1536 KM6203	Crankshaft timing pin (7 x 80)
9	4880177	-	H.T. Setscrew M8x60 zinc plate
10	4880178	MOT 1534 KM6205	Inlet cam setting tool (chem. black)
11	4880176	MOT 1537 KM6205	Exhaust cam setting tool

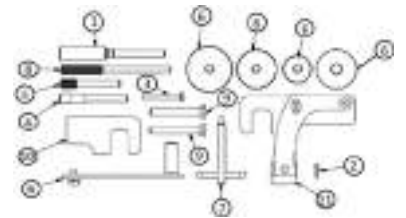

OPEL

829056 - ENGINE TIMING KIT RENAULT/OPEL/NISSAN DIESEL (CHAIN DRIVE) - 1.6, 2.0, 2.3

The 829056 has been specifically put together to allow the user to lock the engine components of the 1.6, 2.0 and 2.3 Renault engines used across the Renault, Opel and Nissan ranges. The 829056 kit includes the essential tools required to allow the removal and replacement of the engine timing chain.

COMPONENTS

REF	ART. NO.	OEM	DESCRIPTION
1	4880122	MOT 1766, EN48330	Crankshaft locking pin
2	4880119	MOT 1769, EN48332, MOT 1969 (1.6L)	Camshaft setting tool (MOT 1769)
3	4880121	KM 6130	Auxiliary belt tensioner locking pin
4	4880118	MOT 1770, KM 956-1, EN-48334	Crankshaft pulley holding tool
5	4880120	MOT 1773, EN48331	Camshaft gear alignment tool
6	4880201	-	Locking pin
7	4880210	-	4mm hex key
8	4880330	-	M6 x 40 HT setscrew
9	4880293	MOT 1970	Crankshaft timing pin Renault OEM MOT1970
10		MOT 1969	For 1.6l engines (R9M)
11		MOT 1769	For 2.0l/2.3l engines (M9R/M9T)

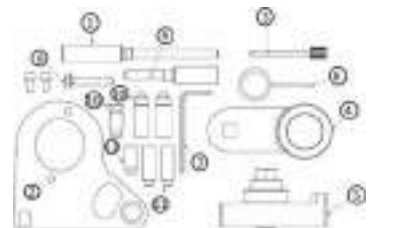

OPEL

829060 - ENGINE TIMING KIT OPEL PETROL (CHAIN DRIVE DOHC (A12/A14) - 1.2, 1.4

The 829060 has been developed to allow the user to lock the cam and crankshafts in position to allow the removal and replacement of the timing chain fitted to the Vauxhall/Opel twin cam engines listed on our website. The 829060 kit is a 7 piece tool kit made up of the required camshaft and crankshaft locking tools.

COMPONENTS

REF	ART. NO.	OEM	DESCRIPTION
1	4880276	EN-49977-200	Vauxhall camshaft locking tool EN-49977-100
2	4880244	EN-49977-100	Camsprocket locking tool (EN-49977-200)
3	4880277	EN-49978	Camshaft locking tool (EN-49978)
4	4880170	KM-953-A	Camshaft setting plate (chem. black)
5	4880171	KM-952	Flywheel locking pin
6	4880173	KM-955-2	Tensioner location pin 4mm
7	4880172	KM-955-1	Tensioner location pin 2.5mm

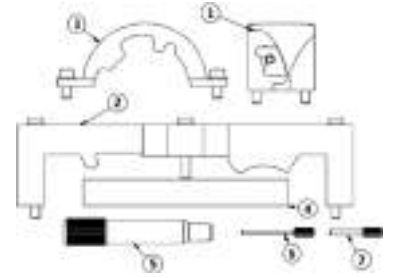
OPEL
829061 - ENGINE TIMING KIT OPEL/CHEVROLET DIESEL (Z20) - 2.0

Developed for the Vauxhall/Chevrolet 2.0 common rail diesel engine found in the Vauxhall Antara, Chevrolet Captiva, Cruze, Epica, Lacetti and Nubira. This kit holds the correct timing position of the crankshaft and camshaft whilst changing the timing belt on the 16V SOHC belt driven diesel engines.

COMPONENTS

REF	ART. NO.	OEM	DESCRIPTION
1	4880012	EN-48245	Camshaft locking tool assembly (EN48245)
2	4880011	EN-48246	Crankshaft locking pin (EN48246)

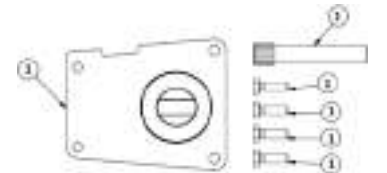
OPEL
829062 - ENGINE TIMING KIT OPEL, RENAULT, SAAB DIESEL DOHC CDTi - 1.9

The 829062 provides the essential tools required to replace the camshaft drive belt and remove the camshafts on the Vauxhall/Opel CDTi 1.9/2.0lt twin cam diesel engines listed below.

COMPONENTS

REF	ART. NO.	OEM	DESCRIPTION
1	4880137	EN-46788	Stud Assy
2	4880185	KM-6130, 6349	Auxiliary drive belt tensioner locking pin (4 x 55)
3	4880187	EN-46788/1, 32 025 009	Crankshaft alignment tool
4	4880188	EN-46789, 32 025 008	Camshaft alignment tool
5	4880189	EN-46789-100	Camshaft setting pin Assy.
6	4880332	SSM8x20B	M8 x 20 H.T. setscrew

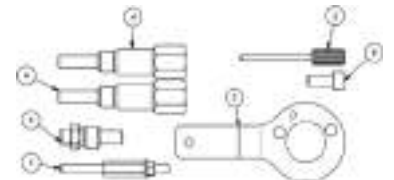
OPEL
829063 - ENGINE TIMING KIT OPEL/FIAT/FORD/PSA DIESEL JTD/HDI - 1.3

This is an essential engine timing tool set that provides the camshaft and crankshaft timing tools only.

COMPONENTS

REF	ART. NO.	OEM	DESCRIPTION
1	4880183	104-A, EN 46781	Camshaft alignment tool Assy
2	4880186	-	Crankshaft pin Assy
3	4880096	EN-46785	Locking pin (8mm dia. 70 long)

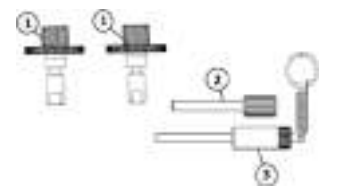
OPEL

Sonic timing tools

829064 - ENGINE TIMING KIT OPEL/CHEVROLET/SAAB PETROL (A20/A24) - 2.0, 2.4

Developed specifically for the high power output 2.0 litre and 2.4 litre twin cam turbo charged petrol engines found across the GM, Chevrolet and Saab ranges. This kit provides all the components required to set and hold the camshafts, crankshaft and chain tensioner components when performing major engine work or replacing the cam chain and associated components.

COMPONENTS

REF	ART. NO.	OEM	DESCRIPTION
1	4880231	EN-49212, EN-49212-1	Vauxhall - Opel - camshaft locking tool LHS [OEM ref: EN-492]
2	4880232	EN-49212, EN-49212-2	Vauxhall - Opel - camshaft locking tool RHS [OEM ref: EN-492]
3	4880317	EN-48953	Camshaft adjuster holding tool
4	4880318	EN-48585	Crankshaft bolt hole balancer
5	4880320	J45027-2, EN45027-2, EN-45027,	Tension plunger holder
6	4880321	EN-45027-1, J-45027-1	Tension plunger remover
7	4880319	EN-43653, J43653	Flywheel holding tool bottom half
8	4880135	EN-43653, J43653	Flywheel holding tool
9	4880214	-	M6 x 50 caphead screw
10	4880010	-	Washers M6 form C Zc.PL
11	4880173	EN-955-20, KM 955-20	Tensioner location pin 4mm
12	4880172	EN-955-10, KM955	Tensioner location pin 2.5mm
13	4880215	-	M6 x 16 cap head screw self-colour to BS4168

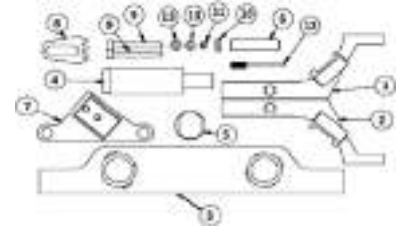

OPEL



829065 - CAMSHAFT ALIGNMENT KIT OPEL/SAAB PETROL TURBO (Z20/B20) - 2.0

The 829065 kit has been developed to change the camshaft drive chain on the twin cam chain driven 2.0lt turbo petrol engines found in the Vauxhall and Saab ranges from 2002 to 2012.

829065 is an 4 piece kit consisting of the components required to lock the camshaft, hold the crankshaft and set the chain tensioner when replacing the timing chain.

COMPONENTS

REF	ART. NO.	OEM	DESCRIPTION
1	4880298	KM-6362-1 EN-48366-001	Camblock with inlet marking for vauxhall Z20NET engine [2.0L]
2	4880299	KM-6362-2 EN-48366-002	Camblock with exhaust marking for vauxhall Z20NET engine [2.
3	4880180	KM-6077 83 96 392	Tension pin 1.0
4	4880230	KM-J-38122-A 83 96 210	Holding tool (KM-J-38122-A)

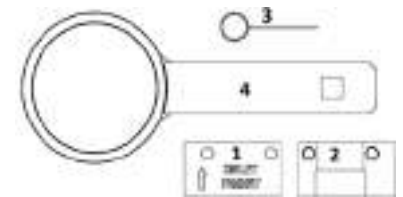

OPEL



829088 - CAMSHAFT HOLDING TOOL FIAT/FORD/OPEL DIESEL JTD - 1.3

The 829088 camshaft pulley holding tool has been designed to allow the user to loosen and tighten the camshaft pulley fixings without moving the camshafts or causing damage to any timing tools that may be fitted. Conveniently designed to allow the use of a 1/2 drive wrench the 829088 combines the double headed OEM tool into one single tool.

COMPONENTS

REF	ART. NO.	OEM	DESCRIPTION
1	829088	1 871 008 600 303-1475	Camshaft holding tool Fiat/Ford/Opel diesel JTD - 1,3

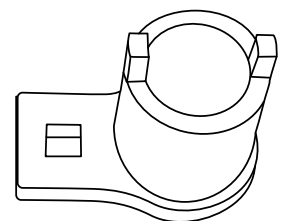

OPEL



829091 - CRANKSHAFT HOLDING TOOL OPEL 2.0, 2.2

The 829091 is designed to hold the front crankshaft pulley while tightening or loosening the pulley fixings on the GM/Opel/Saab 2.0lt and 2.2 lt petrol engines.

COMPONENTS

REF	ART. NO.	OEM	DESCRIPTION
1	4880230	KM-J-38122-A	Holding tool (KM-J-38122-A)



OPEL



829116 - ENGINE TIMING KIT VAUXHALL/OPEL 1.6 CDTI

A comprehensive kit to lock the 1.6 diesel engine into its timed position for the removal and replacement of the timing chain to the models listed. Included in this kit is the added component of the camshaft sprocket support bracket that is required when removing the camshaft for essential work on the cam followers. Applications: Astra-J, Astra-K, GTC, Insignia-A, Meriva-B, Mokka, Mokka X & Zafira-C Tourer (from 2013) CDTi EcoFlex. Engine codes: B16DTC, B16DTE, B16DTH, B16DTJ, B16DTL, B16DTN, B16DTR, B16DTU.

OPEL

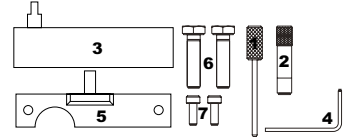

COMPONENTS

REF	ART. NO.	OEM	DESCRIPTION
1	4880185	EN-6349 EN6130	Auxiliary drive belt tensioner locking pin (4 x 55)
2	4880355	EN-51143	Camshaft alignment setting pin
3	4880356	EN-51140	Crankshaft alignment tool
4	4880348	EN-50513	Tensioner locking pin
5	4880357	EN-51188	Camshaft sprocket holding tool
6	4880347	-	M10 x 40 hex head bolt
7	4880215	-	M6 x 16 cap head screw self-colour to bs4168

829119 - ENGINE TIMING KIT VAUXHALL/OPEL 1.6 SIDI PETROL

Specially designed crankshaft pulley holding tool designed to be used with a 1/2" D power bar. Applications: SIDI Turbo, SIDI Turbo EcoFLEX; Vauxhall; Astra-J (2013-2015), Astra-K (from 2015), Cascada (from 2013), GTC (from 2015), Insignia (2013-2017), Zafira-C Tourer (from 2013). Specifically designed for A16XHT, A16SHT, B16XHT, B16SHT and B16SHL petrol turbo engines.

OPEL

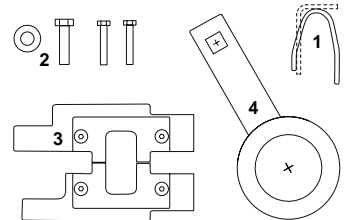

COMPONENTS

REF	ART. NO.	OEM	DESCRIPTION
1	4880370	EN-6349 EN6130	Balance shaft sprocket locking
2	4880348	EN-51143	Tensioner locking pin
3	4880369	EN-51140	Camshaft holding & alignment tool
4	4880368	EN-50513	Crankshaft pulley holding tool

829127 - ENGINE TIMING TOOL KIT - VAUXHALL/OPEL 2,0CDTI

This kit has been developed to lock the main engine components on the latest Vauxhall/Opel CDTi 2.0L engines from 2014 onwards, to allow removal and replacement of the camshaft drive belt. The kit also contains the tool required to lock the flywheel on vehicles fitted with automatic transmission. NB: for replacement of the camshaft drive chain in the cylinder head additional tooling will be required - 829128.

OPEL

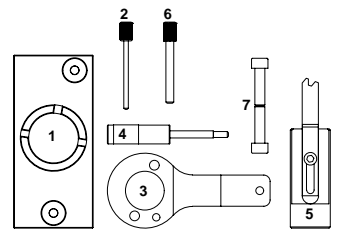

COMPONENTS

REF	ART. NO.	OEM	DESCRIPTION
1	4880394	EN-51413	High pressure fuel pump sprocket locking tool
2	4880121	EN-955-2	Auxiliary belt tensioner locking pin
3	4880397	EN-51412	Crankshaft timing tool
4	4880396	EN-51414	Camshaft locking pin
5	4880398	EN-51411	Crankshaft pulley holding tool assy
6	4880353	-	M8 x 30 cap head
7	4880354	EN-51412	Locking pin 6.35 X 50mm

829128 - ENGINE TIMING CHAIN KIT - VAUXHALL/OPEL 2,0CDTI

Developed to allow the user to lock the camshafts of the vehicles listed in to their "timed" position for the removal and replacement of the camshaft drive chain within the head and removal of the camshafts. **NB: Additional tooling is required if the timing belt is to be replaced to lock the crankshaft and camshaft belt sprockets, please see 829127 for additional tools.

OPEL

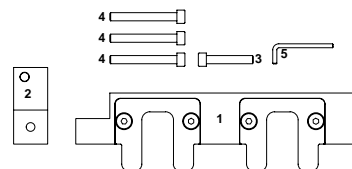

COMPONENTS

REF	ART. NO.	OEM	DESCRIPTION
1	4880393	EN-51415	Camshaft locking tool assembly
2	4880395	-	Camshaft locking tool beam extension block
3	4880274	EN-51418	Locking pin
4	4880214	-	M6 x 50 caphead screw
5	4880350	-	M6 x 35 socket head cap screw

Sonic timing tools

829132 - AUXILIARY BELT TENSIONER SPANNER 15MM VAUXHALL/OPEL

Part of the Sonic range of timing tools for Vauxhall, Opel engines

COMPONENTS

REF	ART. NO.	OEM	DESCRIPTION
1	829132	KM-913-A, EN-913-A	Auxiliary belt tensioner spanner 15mm Vauxhall/Opel



OPEL



829134 - ENGINE TIMING KIT - RENAULT/NISSAN/MERCEDES/VAUXHALL 1,6D

829134 has been developed specifically for the 1.6 R9M diesel engines fitted across the Renault, Nissan, Vauxhall/Opel and Mercedes-Benz ranges as listed. The 829134 contains all the essential tools required to lock the engine in its "timed" position for safe removal and replacement of the camshaft drive chain.

COMPONENTS

REF	ART. NO.	OEM	DESCRIPTION
1	4880359	626 589 04 40 00, MOT 1969	Camshaft alignment tool
2	4880118	626 589 02 40 00, MOT 1770 EN956-1, EN48334	Crankshaft pulley holding tool
3	4880201	-	Locking pin
4	4880121	KM 6130	Auxiliary belt tensioner locking pin
5	4880293	629 589 00 15 00, MOT 1970	Crankshaft timing pin Renault OEM MOT1970

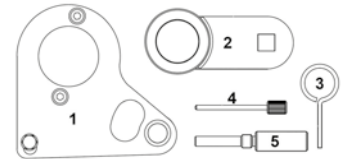

OPEL



829016 - ENGINE TIMING & REBUILD SET FIAT, OPEL, FORD, PSA JTD DIESEL - 1.3

The 829016 has been developed to allow the user to change the cam chain on the later 1.3 JTD/CDTi & HDi diesel engines found in the PSA, Fiat, Ford, Suzuki and Opel ranges.

COMPONENTS

REF	ART. NO.	OEM	DESCRIPTION
1	4880200	1 871 000 200, 303-1469, KM-662-C	Crankshaft pulley flange holding tool
2	4880004	1 870 900 400	Timing chain tensioning tool
3	4880005	0104-C, 1 870 900 300, 303-1468	Crankshaft alignment tool
4	4880183	0104-A, 1 871 000 900, 1 860 985 000, EN 46781, 09917-68610	Camshaft alignment tool assy
5	4880186	EN 46785, 09912-38300	Crankshaft pin assy
6	4880096	Fiat 8mm pin	Locking pin (8mm dia. 70 long)

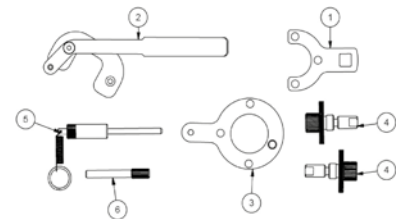

PSA - PEUGEOT - CITROËN



829018 - ENGINE TIMING KIT FIAT, PSA, IVECO JTD DIESEL - 2.8

The 829018 has been developed for Fiat 2.8 diesel engines that are found in the Fiat, Iveco and PSA van ranges. This kit provides all the tools required to set the timed components when replacing the timing belt. The kit also includes the components require to lock the flywheel when undoing and tightening up the front pulley fixings as well as the special spacer to hold the belt tensioner in its fully retracted position.

COMPONENTS

REF	ART. NO.	OEM	DESCRIPTION
1	4880237	1 870 765 001	Flywheel locking piece (Fiat)
2	4880090	1 860 617 000	Setting pin 5.0mm (5 x 50)
3	4880097	8mm pin	Locking pin (8mm dia. x 60 long)
4	4880132	1 860 638 000	Tensioning tool

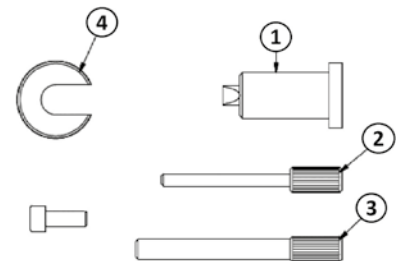

PSA - PEUGEOT - CITROËN



829023 - ENGINE TIMING KIT FORD, PSA, FIAT TDCI, HDI DIESEL - 1.4, 1.5, 1.6

The 829023 is an engine timing kit specifically designed for the Ford/PSA 1.4/1.6 TDCI/HDI diesel engines found across the Ford, PSA and Fiat ranges.

COMPONENTS

REF	ART. NO.	OEM	DESCRIPTION
1	4880090	303-732, 21-260	Setting pin 5.0mm [5 x 50]
2	4880096	303-735, 21-263	Locking pin [8mm dia. 70 long]
3	4880064	303-734, 21-262	Flywheel locking pin [12 x 55]
4	4880061	303-393, 21-168	Flywheel locking tool-Ford
5	4880062	303-393-01	Tooth block item 2
6	4880063	303-293-02	Short tooth block

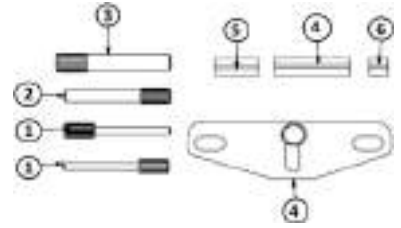
PSA - PEUGEOT - CITROËN

829026 - ENGINE TIMING KIT FIAT, PSA, OPEL, IVECO JTD DIESEL - 2.5

The 829026 is a small diesel locking kit specifically assembled to cover the 2.5/2.8 belt driven diesel engines found in the Citroën, Peugeot, Renault and Fiat ranges.

COMPONENTS

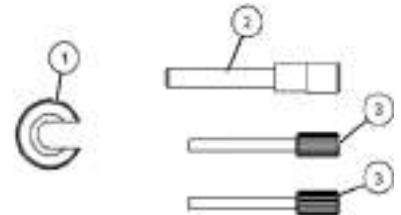
REF	ART. NO.	OEM	DESCRIPTION
1	4880132	1 860 638 000	Tensioning tool
2	4880095	1 870 667 000, 1 870 765 001	Locking pin [zinc pl.]
3	4880090	1 860 617 000	Setting pin 5.0mm [5 X 50]

PSA - PEUGEOT - CITROËN

08
829030 - ENGINE TIMING KIT BMW, PSA PETROL N12, N14 -1.4, 1.6

The 829030 has been developed to allow the removal and fitting of the camshaft drive chains on the PSA/Mini 1,4 and 1,6 petrol engines.

COMPONENTS

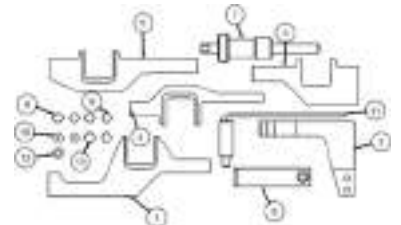
REF	ART. NO.	OEM	DESCRIPTION
1	4880035	11 9 540 / 0197-A3	Camshaft alignment tool body type 2 [of 2]
2	4880034	119540 / 0197-A3	Camshaft alignment tool body type 1 [of 2]
3	4880036	11 9 540 / 0197-A1	Camshaft alignment tool item 1 of 2 (OEM 119 540QC4 item 1)
4	4880030	11 9 550 / 0197-A2	Camshaft alignment tool (119 550/551) inlet setting plate
5	4880031	11 9 551	Camshaft alignment plate (OEM 119 550/551 - exhaust setting)
6	4880032	11 9 552	Support clamp BMW (oem 119 550/552)
7	4880026	11 9 340	Timing chain pre-tensioning tool assembly (11 9 340)
8	4880134	-	M6 x 30 hex head setscrew black [self colour]
9	4880028	-	M6 x 30 hex head setscrew
10	4880322	-	Shank bolt 6 x 12 x M5 thread
11	4880033	11 9 590 / 0197-B	Crankshaft setting pin G.A-BMW
12	4880181	-	M6 x 20 H T setscrew S/C
13	4880216	-	M6 x 30 cap head screw

PSA - PEUGEOT - CITROËN

829035 - ENGINE TIMING KIT PSA PETROL - 1.4

The 829035 has been developed to offer the required engine locking tools to fit the popular PSA 1.4 belt driven 16v and 8v petrol engines. Fitted to the models listed between 2000 and 2013.

COMPONENTS

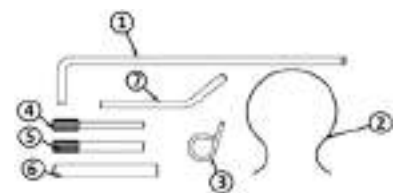
REF	ART. NO.	OEM	DESCRIPTION
1	4880235	0132QY	Flywheel locating pin (PSA 0132QY)
2	4880112	4533-TAD/0132-AK	Timing belt retaining clip
3	4880228	3mm pin	3mm formed locking pin (yellow passivate)
4	4880090	0194-A	Setting pin 5.0mm [5 x 50]
5	4880096	4533-TAC1/0132-AJ1	Locking pin [8mm dia. 70 long]
6	4880054	0132RZ/4507-TB	Pin dia. 10 X 80 long
7	4880053	4507-TA	Setting pin 6 x 140 D

PSA - PEUGEOT - CITROËN

Sonic timing tools

829036 - ENGINE TIMING KIT PSA PETROL 3 CYLINDER - 1.0, 1.2

The 829036 has been developed for the latest generation of Citroën/Peugeot 1.0lt and 1.2lt 3 cylinder petrol engines. The 829036 engine timing kit has been designed to hold the cam shafts and crankshaft in their timed position during belt replacement. The 829036 is made up of a 2 piece camshaft locking bridge and 1 piece crankshaft setting pin.

COMPONENTS

REF	ART. NO.	OEM	DESCRIPTION
1	4880300	0109-2A	Assembly detail for k00605 PSA 1.0/1.1 VVT 3 cylinder timing
2	4880303	0109-2B	Flywheel timing pin for PSA 1.0 & 1.2 assembly
3	-	-	With part 4880300, item 3 will be included



PSA - PEUGEOT - CITROËN

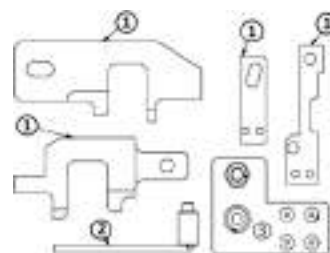

829038 - ENGINE TIMING KIT PSA PETROL (EW) - 2.0, 2.2 16V

The 829038 engine timing kit allows the valve timing to be set and maintained during cam belt replacement on the popular EW coded PSA engines used across the Citroën and Peugeot ranges.

COMPONENTS

REF	ART. NO.	OEM	DESCRIPTION
1	4880055	0189C	Flywheel locking pin
2	4880074	0189R	Crankshaft setting pin
3	4880075	0189S1	Tensioner adjuster - assembly
4	4880076	0189S2	Tension gauge
5	4880097	0132AJ2, 0188M, 4533TAC2	Locking pin (8mm dia x 60)
6	4880090	0132AB, 0178D, 4527-TS2	Setting pin 5.0mm [5 x 50]
7	4880096	5711-TD	Locking pin (8mm dia. 70 long)
8	4880099	0189AZ	Timing pins item 2
9	4880100	0189L	Locking pin
10	4880098	0189A	Timing pins item 1
11	4880112	0188K, 0132AK, 0153AK, 0187J, 4533-TAD	Timing belt retaining clip



PSA - PEUGEOT - CITROËN

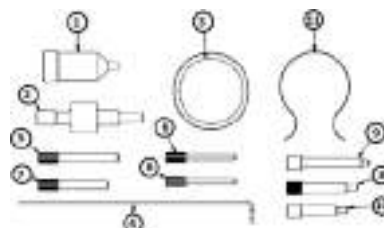

829039 - ENGINE TIMING KIT FIAT, OPEL, FORD, PSA JTD DIESEL - 1.3

The 829039 engine timing kit allows the valve timing to be set on the current 1,3 Multijet Fiat derived diesel engines found across the Fiat, Ford, Opel & PSA ranges.

COMPONENTS

REF	ART. NO.	OEM	DESCRIPTION
1	4880135	153A	Flywheel holding tool
2	4880183	21 860 985 000, EN 46781, 303-1472, 0104-A	Camshaft alignment tool assy.
3	4880005	1 870 900 300, 303-1468, 0104-C	Crankshaft alignment tool
4	4880280	303-1475, 1 871 008 600	Ford 1.3 diesel camshaft support tool Ø36 ID



PSA - PEUGEOT - CITROËN

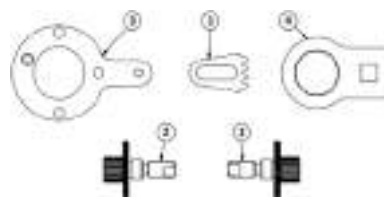

829040 - ENGINE TIMING KIT JAGUAR LAND ROVER, FORD, PSA DIESEL DW12 - 2.2

The 829040 is a compact tool set which includes the camshaft sprocket, flywheel locking tools and flywheel timing pin required when setting the valve timing and/or changing the timing belt on DW12 (2,2lt) diesel engines found in the Land Rover, Ford, Peugeot and Citroën ranges.

COMPONENTS

REF	ART. NO.	OEM	DESCRIPTION
1	4880096	303-1277, 0188.M	Locking pin (8mm dia. 70 long)
2	4880061	303-1272, 0188.F	Flywheel locking tool-Ford
3	4880068	303-1270, 303-1059	Timing pin
4	4880080	0188AH	Centraliser spring - 1.4mm dia
5	4880106	0188F	Flywheel lock (zinc PL.)

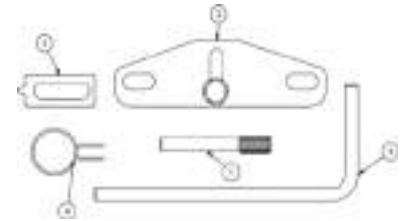

PSA - PEUGEOT - CITROËN

829041 - ENGINE TIMING & REBUILD SET PSA, FIAT DW10, DW12 - 2.0, 2.2

The 829041 kit brings together the tools required to set the valve timing on the extensive range of DW10 2,0 and DW12 2,2 Diesel engines as well as the DV4 1,4 and DV6 1,6 diesel engines found across the PSA and Fiat ranges.

COMPONENTS

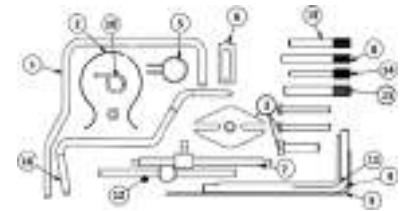
REF	ART. NO.	OEM	DESCRIPTION
1	4880072	7099-TM	Crankshaft pin - 8 X 380
2	4880112	0188K, 0132AK, 0153AK, 0187J, 4533-TAD	Timing belt Retaining clip
3	4880113	0188P, 7015-T, 0188P2	Puller beam
4	4880068	303-1059	Timing pin
5	4880080	0188AH	Centraliser spring - 1.4mm dia
6	4880106	0188F	Flywheel lock (zinc PL.)
7	4880108	0188J2	Tension adjustment tool
8	4880097	0188M	Locking pin (8mm dia x 60)
9	4880227	0188Q2	2mm formed locking pin (BZP) 210 x 50
10	4880228	0153AL	3mm formed locking pin (yellow passivate)
11	4880060	0188Q1	4.0mm setting pin
12	4880104	0188J/J1	Tension adjustment tool
13	4880096	0189B	Locking pin (8mm dia. 70 long)
14	4880090	0178D, 303-732, 0194A	Setting pin 5.0mm [5 x 50]
15	4880064	303-734, 0194C	Flywheel locking pin (12 x 55)
16	4880255	0.532Y, 9967.34	8mm multi-bend flywheel timing pin



PSA - PEUGEOT - CITROËN

08
829063 - ENGINE TIMING KIT OPEL/FIAT/FORD/PSA DIESEL JTD/HDI - 1.3

This is an essential engine timing tool set that provides the camshaft and crankshaft timing tools only.

COMPONENTS

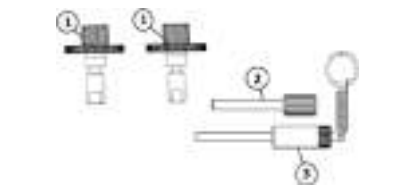
REF	ART. NO.	OEM	DESCRIPTION
1	4880183	104-A, EN 46781	Camshaft alignment tool assy
2	4880186	-	Crankshaft pin assy
3	4880096	EN-46785	Locking pin (8mm dia. 70 long)

PSA - PEUGEOT - CITROËN

Sonic timing tools

829107 - OIL PUMP ALIGNMENT PLATE FORD, JAGUAR, LAND ROVER, ROVER, PSA DURATORQ DIESEL 2.0, 2.2, 2.4, 3.2

The 829107 oil pump alignment tool has been developed to allow the user to correctly align the engine oil pump in the sump after an engine rebuild etc. it is important that the pump be correctly and accurately aligned to ensure the oil pump sprocket is not operating with excessive side loads.

COMPONENTS

REF	ART. NO.	OEM	DESCRIPTION
A	829107	303-705, 303-1093, 0198.H	Oil pump alignment plate Ford/Jaguar Land Rover/PSA diesel



NOTE : l'utilisation de ce kit nécessite l'acquisition d'outils supplémentaires.



PSA - PEUGEOT - CITROËN

829022 - TWIN CAMSHAFT LOCKING TOOL OPEL, FIAT PETROL - 2.2

The 829020 has been developed to lock the cam and crankshaft in position to allow the removal and replacement of the timing belt fitted to the current generation 1.4 Fiat MultiAir engines.

COMPONENTS

REF	ART. NO.	OEM	DESCRIPTION
1	4880179	KM 6148	Camshaft locking tool (assembled)
2	4880180	KM 6077	Tension pin 1.0

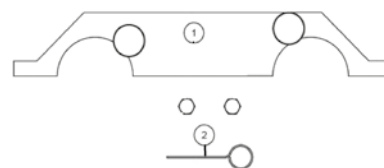

RENAULT - DACIA

829054 - ENGINE TIMING KIT RENAULT/NISSAN PETROL (K4) - 1.6, 2.0

The 829054 offers the essential engine timing tools required for the Renault petrol 16V belt driven 1.6L and 2.0L engines. The 829054 kit of four tools enables the correct engine timing to be performed on Renault K4J, K4M & F4P, F4R engines, when changing the timing belt. The set includes 2 crankshaft timing pins and camshaft setting bar with the bracket specifically for the K4M 813 engine from 2003 onwards.

COMPONENTS

REF	ART. NO.	OEM	DESCRIPTION
1	4880048	MOT 1489	Crankshaft locking pin (chem. black)
2	4880095	MOT 1054	Locking pin (zinc PL.)
3	4880109	MOT 1496	Camshaft setting bar - Renault
4	4880111	MOT 1750	Mounting bracket (MOT 1759)

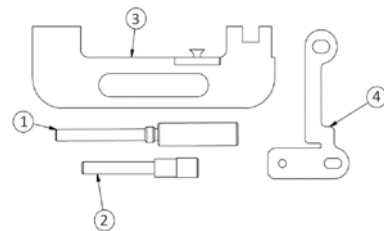

RENAULT - DACIA

829055 - ENGINE TIMING KIT RENAULT/OPEL/NISSAN DIESEL (BELT DRIVE) - 1.5, 1.9, 2.2, 2.3, 2.5

The 829055 offers the essential engine timing tools required for the Renault belt driven DCI range of diesel engines. It includes the tools required for 1.5, 1.9, 2.2, 2.3 and 2.5 DCi diesel engines found in the Dacia, Nissan, Renault, Suzuki and Opel/Vauxhall ranges.

COMPONENTS

REF	ART. NO.	OEM	DESCRIPTION
1	4880048	MOT 1489	Crankshaft locking pin (chem. black)
2	4880047	-	Washer M8 zinc plated
3	4880073	-	Ht setscrew M6 x 45 Zc.PL.
4	4880095	MOT 1054	Locking pin (zinc PL.)
5	4880096	MOT 1430	Locking pin (8mm dia. 70 long)
6	4880116	MOT 1543	Tensioning tool - Renault 19 DCI
7	4880174	MOT 1538	High pressure pump pin C/W T/bar
8	4880175	MOT 1536 KM6203	Crankshaft timing pin (7 x 80)
9	4880177	-	H.T. Setscrew M8x60 zinc plate
10	4880178	MOT 1534 KM6205	Inlet cam setting tool (chem. black)
11	4880176	MOT 1537 KM6205	Exhaust cam setting tool

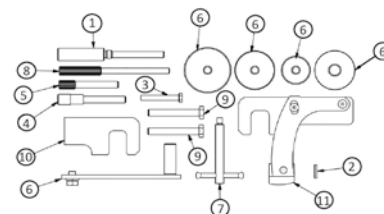

RENAULT - DACIA

829056 - ENGINE TIMING KIT RENAULT/OPEL/NISSAN DIESEL (CHAIN DRIVE) - 1.6, 2.0, 2.3
RENAULT - DACIA

The 829056 has been specifically put together to allow the user to lock the engine components of the 1.6, 2.0 and 2.3 Renault engines used across the Renault, Opel and Nissan ranges. The 829056 kit includes the essential tools required to allow the removal and replacement of the engine timing chain.

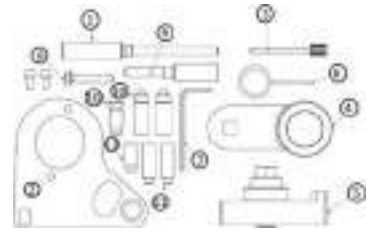
COMPONENTS

REF	ART. NO.	OEM	DESCRIPTION
1	4880122	MOT 1766, EN48330	Crankshaft locking pin
2	4880119	MOT 1769, EN48332, MOT 1969 (1.6L)	Camshaft setting tool (MOT 1769)
3	4880121	KM 6130	Auxiliary belt tensioner locking pin
4	4880118	MOT 1770, KM 956-1, EN-48334	Crankshaft pulley holding tool
5	4880120	MOT 1773, EN48331	Camshaft gear alignment tool
6	4880201	-	Locking pin
7	4880210	-	4mm hex key
8	4880330	-	M6 x 40 HT setscrew
9	4880293	MOT 1970	Crankshaft timing pin Renault OEM MOT1970
10		MOT 1969	For 1.6l engines (R9M)
11		MOT 1769	For 2.0l/2.3l engines (M9R/M9T)

829057 - ENGINE TIMING KIT RENAULT/DACIA PETROL (K7J/K7M) - 1.4, 1.6
RENAULT - DACIA

The 829057 has been specifically put together to allow the user to lock the engine components of the 1.4 and 1.6 Renault engines used across the Dacia range. The 829057 kit includes the belt pre-tensioner lever required on engines equipped with a manual tensioner.

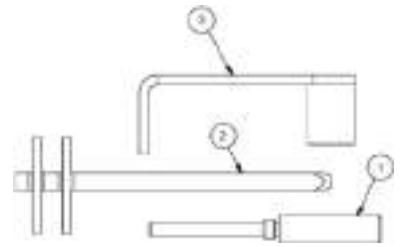
COMPONENTS

REF	ART. NO.	OEM	DESCRIPTION
1	4880048	MOT 1489	Crankshaft locking pin (chem. black)
2	4880102	MOT 1145-01	Tension spanner
3	4880295	MOT 1501	Assembly - belt tensioning tool for Logan, Sandero MOT 1501

829058 - ENGINE TIMING KIT RENAULT PETROL (BELT DRIVE) - 1.4, 1.6, 1.8, 2.0 16V
RENAULT - DACIA

The 829058 has been specifically put together to allow the user to lock the engine components of the 1.4, 1.6, 1.8 and 2.0 16V turbo and non-turbo petrol engines.

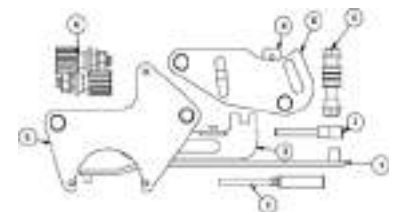
COMPONENTS

REF	ART. NO.	OEM	DESCRIPTION
1	4880048	MOT 1489	Crankshaft locking pin (chem. black)
2	4880095	MOT 1054	Locking pin (zinc PL.)
3	4880109	MOT 1496	Camshaft setting bar - Renault
4	4880111	MOT 1750	Mounting bracket (MOT 1759)
5	4880115	MOT 1490	Camshaft pulley alignment tool - Renault
6	4880117	MOT 1801	Camshaft sprocket locking tool - Renault 2,0 (ENG. F4R)
7	4880323	MOT 1368	Cambelt tensioning tool (3894)

829059 - ENGINE TIMING KIT RENAULT PETROL - 1.2
RENAULT - DACIA

The 829059 has been specifically assembled to provide the essential tools for belt replacement on the Renault 1.2 petrol engines.

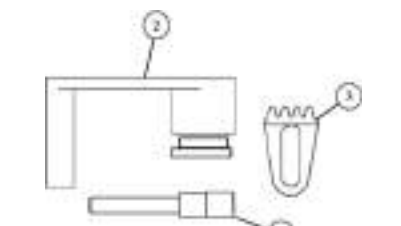
COMPONENTS

REF	ART. NO.	OEM	DESCRIPTION
1	4880095	MOT 1054	Locking pin (zinc PL.)
2	4880103	MOT 1386	Tensioning tool
3	4880307	MOT 582-01	Flywheel locking tool - Renault Clio, Twingo, Kangoo, Megan

Sonic timing tools

829062 - ENGINE TIMING KIT OPEL, RENAULT, SAAB DIESEL DOHC CDTI - 1.9

The 829062 provides the essential tools required to replace the camshaft drive belt and remove the camshafts on the Vauxhall/Opel CDTi 1.9/2.0lt twin cam diesel engines listed below.

COMPONENTS

REF	ART. NO.	OEM	DESCRIPTION
1	4880137	EN-46788	Stud Assy
2	4880185	KM-6130, 6349	Auxiliary drive belt tensioner locking pin (4 x 55)
3	4880187	EN-46788/1, 32 025 009	Crankshaft alignment tool
4	4880188	EN-46789, 32 025 008	Camshaft alignment tool
5	4880189	EN-46789-100	Camshaft setting pin Assy.
6	4880332	SSM8x20B	M8 x 20 H.T. setscrew



RENAULT - DACIA

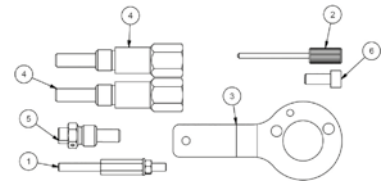

829082 - ENGINE TIMING KIT RENAULT, VOLVO PETROL TWIN CAM 16V/20V - 2.0, 2.4

The 829082 kit provides all the essential engine timing tools to set and lock the engine components of the popular Renault/Volvo 2.0lt and 2.5lt petrol engines to allow camshaft belt replacement. Also offers coverage for the 1.6, 1.8, 1.9 and 2.3 derivatives. See attached applications.
 • Additional recommended tooling – Sonic recommends the use of Sonic 829089 crankshaft pulley holding tool when tightening or loosening the crankshaft pulley fixing bolt.

COMPONENTS

REF	ART. NO.	OEM	DESCRIPTION
1	4880101	MOT 1340, 999 5451	Timing pin
2	4880105	MOT 1348	Tensioning tool (no sleeve)
3	4880107	MOT 1337, 999 5452	Camshaft setting tool
4	4880051	303-507, 999 7152	Mazda screw
5	4880050	303-376B	Camshaft alignment strap (chem. black)
6	-	-	Hex-head bolt for 3



RENAULT - DACIA

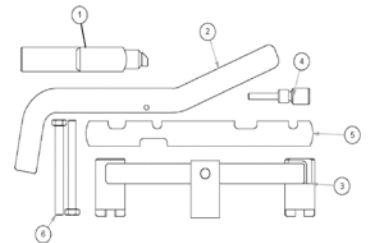

829130 - FLYWHEEL/FRONT PULLEY LOCKING TOOL SET - RENAULT/NISSAN

The 829130 has been developed to provide a locking solution for the flywheel and front pulley on the Renault engines listed below. The kit also provides the primary tools required for timing chain replacement on the Renault twin cam 1.4, 1.6, 2.0, 2.5 and 3.5 litre petrol engines.

COMPONENTS

REF	ART. NO.	OEM	DESCRIPTION
1	4880403	MOT 919-02	Flywheel locking tool - Assy
2	4880402	MOT.1431	Flywheel locking tool - Assy
3	4880414	MOT 1716	Cover/sump/joint separator tool
4	4880401	MOT 2019 / MOT 1789	Crankshaft pulley holding tool



RENAULT - DACIA

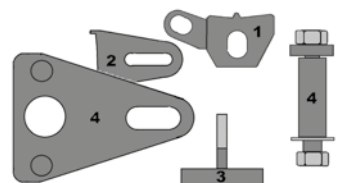

829134 - ENGINE TIMING KIT - RENAULT/NISSAN/MERCEDES/VAUXHALL 1,6D

829134 has been developed specifically for the 1.6 R9M diesel engines fitted across the Renault, Nissan, Vauxhall/Opel and Mercedes-Benz ranges as listed. The 829134 contains all the essential tools required to lock the engine in its "timed" position for safe removal and replacement of the camshaft drive chain.

COMPONENTS

REF	ART. NO.	OEM	DESCRIPTION
1	4880359	626 589 04 40 00, MOT 1969	Camshaft alignment tool
2	4880118	626 589 02 40 00, MOT 1770 EN956-1, EN48334	Crankshaft pulley holding tool
3	4880201	-	Locking pin
4	4880121	KM 6130	Auxiliary belt tensioner locking pin
5	4880293	629 589 00 15 00, MOT 1970	Crankshaft timing pin Renault OEM MOT1970



RENAULT - DACIA

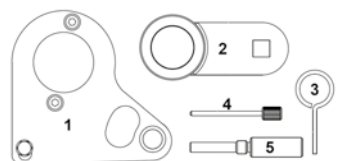

829037 - ENGINE TIMING KIT JAGUAR LAND ROVER DIESEL TDV6 - 2.7

The 829037 engine timing kit allows the valve timing to be set and maintained during cam belt replacement on the popular Jaguar/Land Rover TDV6 diesel engine found across the Jaguar & Land Rover ranges. The 829037 also includes the additional PSA locking tools required for the 2.7 HDI engine found in the Citroën and Peugeot ranges.

COMPONENTS

REF	ART. NO.	OEM	DESCRIPTION
1	4880127	303-1132	Camshaft sprocket timing pin
2	4880079	303-1126	Camshaft sprocket timing pin
3	4880129	303-1116	Fly wheel locking tool
4	4880128	303-1117	Fly wheel locking tool 2
5	4880077	0195-K	Flywheel locking pin Peugeot 0195-K
6	4880078	0195-C	Coolant pump pulley pin Peugeot 0195-C

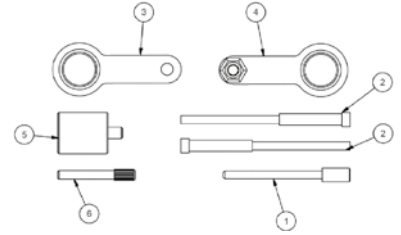
ROVER - LAND ROVER

829040 - ENGINE TIMING KIT JAGUAR LAND ROVER, FORD, PSA DIESEL DW12 - 2.2

The 829040 is a compact tool set which includes the camshaft sprocket, flywheel locking tools and flywheel timing pin required when setting the valve timing and/or changing the timing belt on DW12 (2.2t) diesel engines found in the Land Rover, Ford, Peugeot and Citroën ranges.

COMPONENTS

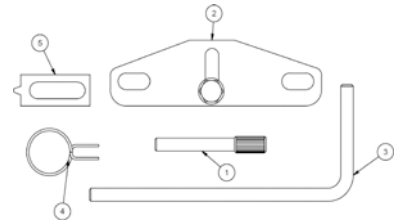
REF	ART. NO.	OEM	DESCRIPTION
1	4880096	303-1277, 0188.M	Locking pin (8mm dia. 70 long)
2	4880061	303-1272, 0188.F	Flywheel locking tool-Ford
3	4880068	303-1270, 303-1059	Timing pin
4	4880080	0188AH	Centraliser spring - 1.4mm dia
5	4880106	0188F	Flywheel lock (zinc PL.)

ROVER - LAND ROVER

08
829107 - OIL PUMP ALIGNMENT PLATE FORD, JAGUAR, LAND ROVER, ROVER, PSA DURATORQ DIESEL 2.0, 2.2, 2.4, 3.2

The 829107 oil pump alignment tool has been developed to allow the user to correctly align the engine oil pump in the sump after an engine rebuild etc. It is important that the pump be correctly and accurately aligned to ensure the oil pump sprocket is not operating with excessive side loads.

COMPONENTS

REF	ART. NO.	OEM	DESCRIPTION
A	829107	303-705, 303-1093, 0198.H	Oil pump alignment plate Ford/Jaguar Land Rover/PSA diesel

ROVER - LAND ROVER



NOTE : l'utilisation de ce kit nécessite l'acquisition d'outils supplémentaires.

829126 - ENGINE TIMING KIT - JLR 2.0 GTDI

A comprehensive engine timing tool kit for the Jaguar, Land Rover 2.0 Petrol GTDI (Gasoline Turbo Direct Injection) engines.

COMPONENTS

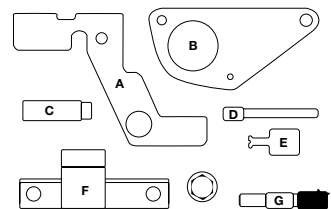
REF	ART. NO.	OEM	DESCRIPTION
A	4880278	303-1600, 303-1565	Ford 2.0 camshaft alignment tool
B	4880390	303-1595	Crankshaft alignment tool plate with guides and pins
C	4880389	303-1595	Threaded bush guide 16 x 56mm
D	4880391	303-1595	Threaded pin 6 x 61
E	4880281	303-1521	Ford cranksaft sensor alignment tool (CKP)
F	4880392	303-1594	Flywheel locking tool
G	4880049	303-748	Crankshaft locking pin - ford (chem. black)

ROVER - LAND ROVER

Sonic timing tools

829015 - ENGINE TIMING KIT FIAT, OPEL, SAAB JTD DIESEL - 1.6, 1.9, 2.0, 2.4

The 829015 engine timing kit has been put together to provide the essential crankshaft and cam shaft timing pins only for the Fiat/Opel JTD diesel engines found across the Fiat, Opel, Saab ranges.

COMPONENTS

REF	ART. NO.	OEM	DESCRIPTION
1	4880188	1.870.896.900, EN-46789, 32 025 008	Camshaft alignment tool
2	4880136	1.860.898.000	Flywheel locking tool
3	4880137	-	Stud assy
4	4880218	-	M8 x 20mm socket head screw
5	4880091	1.860.965.000	Setting pin (chem. black) [6 X 60]
6	4880187	1.860.905.000, 1.860.905.010, 2.000.003.000, EN-46788, 32 025 009	Crankshaft alignment tool

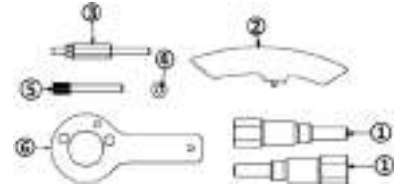

SAAB



829062 - ENGINE TIMING KIT OPEL, RENAULT, SAAB DIESEL DOHC CDTI - 1.9

The 829062 provides the essential tools required to replace the camshaft drive belt and remove the camshafts on the Vauxhall/Opel CDTI 1.9/2.0lt twin cam diesel engines listed below.

COMPONENTS

REF	ART. NO.	OEM	DESCRIPTION
1	4880137	EN-46788	Stud assy
2	4880185	KM-6130, 6349	Auxilliary drive belt tensioner locking pin (4 x 55)
3	4880187	EN-46788/1, 32 025 009	Crankshaft alignment tool
4	4880188	EN-46789, 32 025 008	Camshaft alignment tool
5	4880189	EN-46789-100	Camshaft setting pin assy.
6	4880332	SSM8x20B	M8 x 20 H.T. setscrew

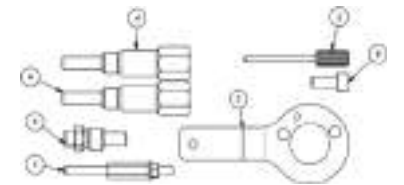

SAAB



829064 - ENGINE TIMING KIT OPEL/CHEVROLET/SAAB PETROL (A20/A24) - 2.0, 2.4

Developed specifically for the high power output 2.0 litre and 2.4 litre twin cam turbo charged petrol engines found across the GM, Chevrolet and Saab ranges. This kit provides all the components required to set and hold the camshafts, crankshaft and chain tensioner components when performing major engine work or replacing the cam chain and associated components.

COMPONENTS

REF	ART. NO.	OEM	DESCRIPTION
1	4880231	EN-49212, EN-49212-1	Vauxhall - Opel - camshaft locking tool LHS (OEM ref: EN-492)
2	4880232	EN-49212, EN-49212-2	Vauxhall - Opel - camshaft locking tool RHS (OEM ref: EN-492)
3	4880317	EN-48953	Camshaft adjuster holding tool
4	4880318	EN-48585	Crankshaft bolt hole balancer
5	4880320	J45027-2, EN45027-2, EN-45027,	Tension plunger holder
6	4880321	EN-45027-1, J-45027-1	Tension plunger remover
7	4880319	EN-43653, J43653	Flywheel holding tool bottom half
8	4880135	EN-43653, J43653	Flywheel holding tool
9	4880214	-	M6 x 50 caphead screw
10	4880010	-	Washers M6 form C Zc.PL
11	4880173	EN-955-20, KM 955-20	Tensioner location pin 4mm
12	4880172	EN-955-10, KM955	Tensioner location pin 2.5mm
13	4880215	-	M6 x 16 cap head screw self-colour to BS4168

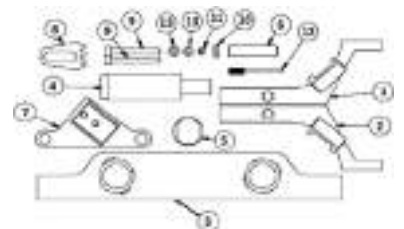

SAAB



829065 - CAMSHAFT ALIGNMENT KIT OPEL/SAAB PETROL TURBO (Z20/B20) - 2.0

The 829065 kit has been developed to change the camshaft drive chain on the twin cam chain driven 2.0lt turbo petrol engines found in the Vauxhall and Saab ranges from 2002 to 2012.

829065 is an 4 piece kit consisting of the components required to lock the camshaft, hold the crankshaft and set the chain tensioner when replacing the timing chain.

SAAB

COMPONENTS

REF	ART. NO.	OEM	DESCRIPTION
1	4880298	KM-6362-1 EN-48366-001	Camlock with inlet marking for vauxhall Z20NET engine [2.0L
2	4880299	KM-6362-2 EN-48366-002	Camlock with exhaust marking for vauxhall Z20NET engine [2.
3	4880180	KM-6077 83 96 392	Tension pin 1.0
4	4880230	KM-J-38122-A 83 96 210	Holding tool (KM-J-38122-A)

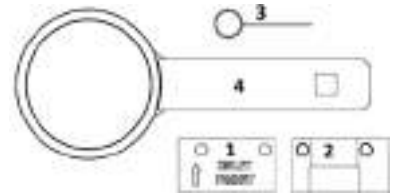

829066 - ENGINE TIMING KIT VAG PETROL TFSI - 1.8, 2.0

The 829066 kit has been designed to allow removal and replacement of the timing chain and camshaft sprockets on the 1.8/2.0 TFSi and TSi petrol engines commonly found in the Volkswagen Audi Group of vehicles. Description: 829066 is an 8 piece kit consisting of the components required to find piston TDC, hold the camshaft pulleys in position and lock the chain tensioners in their retracted positions.

VAG - AUDI - VOLKSWAGEN

COMPONENTS

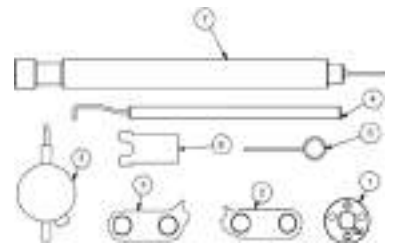
REF	ART. NO.	OEM	DESCRIPTION
1	4880229	T10352	Camshaft control valve tool
2	4880268	T40271-1	Camshaft clamp for VAG 1.8,2.0 4V TFSI timing set - T40271-1
3	4880269	T40271-2	Camshaft clamp for VAG 1.8, 2.0 4V TFSI timing set - T40271-2
4	4880275	T40265	1.8 & 2.0 4V TFSI VAG tension pulley locking pin [T40265]
5	4880144	T40011	Tensioner locking pin 1.4mm BZP & clear passivate
6	4880294	T40267	Vag 1.8, 2.0 4V TFSI tensioner locking clamp [T40267]
7	4880133	T10170	5mm TDC indicator
8	4880123	Vas6079	DTI -ord. style C/W test cert.

08
829067 - ENGINE TIMING KIT VAG PETROL 3 CYLINDER - 1.0

The 829067 kit has been designed to offer the essential timing tools required for the 1.0lt 2 cylinder VAG engines from 2011 on. Description: 829067 is a 3 piece kit consisting of the components required to lock the crankshaft, cam pulleys, camshafts and crankshaft in their timed positions to allow the removal and replacement of the camshaft timing belt.

VAG - AUDI - VOLKSWAGEN

COMPONENTS

REF	ART. NO.	OEM	DESCRIPTION
1	4880297	T10477	Camshaft locking tool for VAG 3 cyl 4V
2	4880199	T10340	Locking pin [T10340]
3	4880324	T10476	Camshaft sprocket locking tool VAG



Sonic timing tools

829068 - ENGINE TIMING KIT VAG DIESEL CR (2012 ON) - 1.6, 2.0

The 829068 kit has been designed to offer the timing tools required for the popular 1.6/2.0 TDi VAG engines to include the latest versions. From 2013 on. The 829068 is a 9 piece kit consisting of the components required to lock the crankshaft, cam pulley and fuel pump pulley in their timed positions to allow the removal and replacement of the camshaft timing belt. 829068 also includes the special VAG sump plug removal tool designed specifically for the plastic sump and timing plugs used on the later 1.6/2.0 TDi CR diesel engines.

COMPONENTS

REF	ART. NO.	OEM	DESCRIPTION
1	4880157	T10060a	Tensioner pin
2	4880092	3359	Injection pump timing pin
3	4880152	T10051	Pulley holding tool G.A VAG
4	4880197	T10264	6mm ball end hex key
5	4880196	T10265	Tensioner pulley locking pin assy Ø2.5. [T10265]
6	4880304	T10490	Machined plate for crankshaft positioning/holding tool
7	4880096	-	Locking pin (8mm dia. 70 long)
8	4880305	T10549	VAG 2.0 4cyl sump plug remover tool
9	4880308	T10492	6mm locking pin

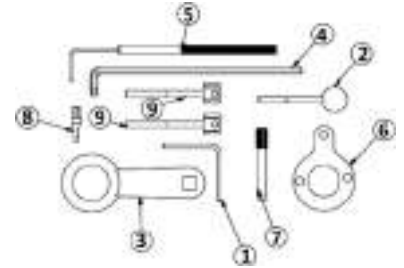

VAG - AUDI - VOLKSWAGEN



829069 - ENGINE TIMING KIT VAG PETROL TSI - 1.2, 1.4

The 829069 kit has been designed to offer the essential tools required to allow the engine timing to be set on the new generation 1.2/1.4 of TSi VAG petrol engines. The kit includes a specially designed cam-locking bar that is equivalent to the OEM tools.

COMPONENTS

REF	ART. NO.	OEM	DESCRIPTION
1	4880309	T10494	VAG camshaft locking tool
2	4880199	T10340	Locking pin (T10340)

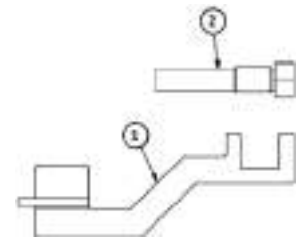

VAG - AUDI - VOLKSWAGEN



829070 - ENGINE TIMING KIT VAG PETROL 3 CYLINDER 6V/12V - 1.2

The 829070 kit provides the essential timing tools required when setting the engine timing on the belt driven 3 cylinder 1.2 six valve and twelve valve petrol engines found across the VAG ranges.

COMPONENTS

REF	ART. NO.	OEM	DESCRIPTION
1	4880192	T10123	Camshaft alignment tool VAG 1.2-12V [OEM T10123]
2	4880194	T10120	Crank alignment pin (chem. black)
3	4880193	T10121	Camshaft alignment pin VAG 1.2-12V [OEM T10120]

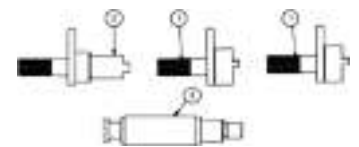

VAG - AUDI - VOLKSWAGEN



829071 - ENGINE TIMING KIT VAG PETROL FSI/TFSI - 1.2, 1.4

The 829071 kit provides the essential timing tools required when removing the camshaft drive chains on the 1.2 and 1.4 FSI/TFSI petrol engines found across the VAG ranges from as early as 2003 to 2015. The kit also includes 2 alignment pins used to help align the supercharger on the engines equipped with a supercharger.

COMPONENTS

REF	ART. NO.	OEM	DESCRIPTION
1	4880262	T10414	Camshaft locking tool
2	4880123	VAS 6079	DTI -ORD. style C/W test cert.
3	4880133	T10170	5mm TDC indicator
4	4880144	T40011	Tensioner locking pin 1.4mm BZP & clear passivate
5	4880159	T10171//T10171A	Camshaft alignment tool
6	4880198	T10341	Guide (T10341)
7	4880199	T10340	Locking pin (T10340)

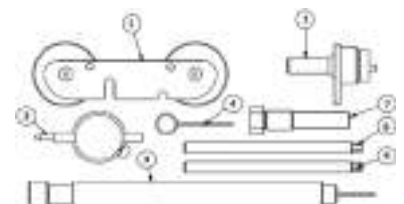

VAG - AUDI - VOLKSWAGEN



829072 - ENGINE TIMING KIT VAG DIESEL TRANSPORTER, LT - 2.4, 2.5

The 829072 kit provides the essential timing tools required for the VW 2.4/2.5 diesel engines listed below.

COMPONENTS

REF	ART. NO.	OEM	DESCRIPTION
1	4880081	2065A	Setting bracket (zinc PL.)
2	4880146	3355	32mm. hex wrench tensioner pulley
3	4880145	T50009	Mm 23161 15x vw crafter crankshaft alignment pin (T50009)
4	4880071	2064	Setting spigot (chem. black) (pin 15.5 X 67)
5	4880167	T10025	Flywheel sprocket holding tool (zinc PL.)

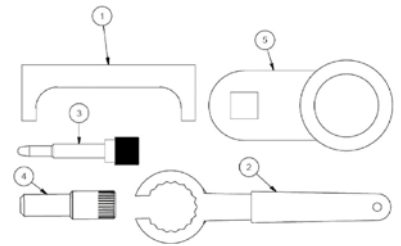
VAG - AUDI - VOLKSWAGEN

829073 - ENGINE TIMING KIT VAG PETROL FSI/TFSI - 2.0

The 829073 kit provides the essential camshaft timing tools required when removing the camshaft drive chain in the cylinder head of the 2.0 TFSI and FSI petrol engines found across the VAG ranges. These engines use a Belt to drive one camshaft and a chain in the rear of the head to drive the second camshaft.

COMPONENTS

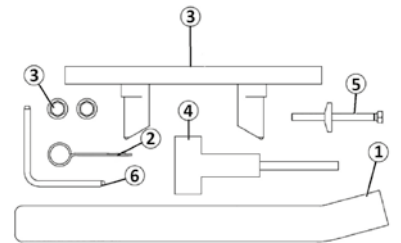
REF	ART. NO.	OEM	DESCRIPTION
1	4880017	T10020//V.159	Tensioner
2	4880144	T40011	Tensioner locking pin 1.4mm BZP & clear passivate
3	4880153	T10252	Camshaft setting tool-VAG FSI T10252
4	4880154	3366	Chain tensioner retainer
5	4880155	T10092	Tensioner bolt
6	4880157	T10060/A	Tensioner pin

VAG - AUDI - VOLKSWAGEN

08
829074 - ENGINE TIMING KIT VAG PETROL FSI V6/V8 - 2.4/3.2

The 829074 kit has the essential timing tools required for the 2.4 and 3.2 V6 FSI engines as well as the 5 cylinder 2.5 FSI petrol engines found in the Audi range.

Equivalent to OEM = T40069, T40070

COMPONENTS

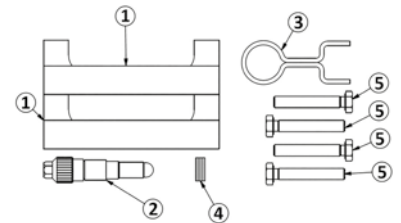
REF	ART. NO.	OEM	DESCRIPTION
1	4880160	T40070	Camshaft alignment tool VAG T40070
2	4880161	T40069	TDC alignment pin VAG T40069
3	4880162	T40071	Clip
4	4880047	-	Washer M8 zinc plated
5	4880212	-	M8 X 50 LG bolt DIN 931

VAG - AUDI - VOLKSWAGEN

829075 - ENGINE TIMING KIT VAG DIESEL V6 TDI - 2.7, 3.0

This kit has been specifically designed as a kit to suit the popular 2.7/3.0 TDi and TDi CR (common rail) chain driven diesel engine found in the VAG range

COMPONENTS

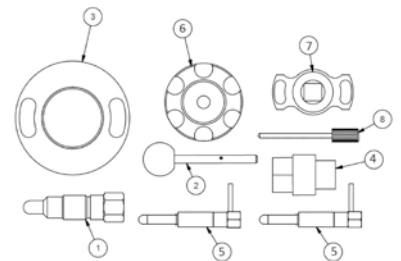
REF	ART. NO.	OEM	DESCRIPTION
1	4880056	3242	Locking pin (chem. black)
2	4880092	3359	Injection pump timing pin
3	4880147	T40049	Crankshaft turning tool (T40049)
4	4880156	T40058	Pulley bolt
5	4880148	T40060	Camshaft alignment pin assembly (T40060)
6	4880149	T40061	Camshaft alignment tool - Audi (T40061)
7	4880150	T40062	Tensioning tool Audi (T40062)
8	4880151	-	Chain tensioner pin

VAG - AUDI - VOLKSWAGEN

Sonic timing tools

829076 - CAMSHAFT SETTING TOOL VAG PETROL 16V FSI (BELT DRIVE) - 1.4, 1.6

A small but essential kit for setting the camshafts on the popular 1.4 and 1.6 Fsi petrol engines found across the VAG ranges from 1996 to 2008. These engines use one belt to transfer the drive from the crankshaft to one camshaft then a second belt to transfer the drive across the camshafts. Depending on the engine specification the cam setting pins may be used with or without the cross bar provided.

COMPONENTS

REF	ART. NO.	OEM	DESCRIPTION
1	4880094	T10016/T10074	Camshaft locking tool - VAG

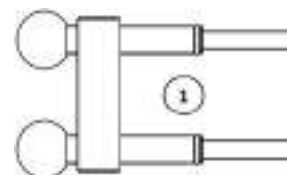

VAG - AUDI - VOLKSWAGEN



829077 - ENGINE TIMING KIT VAG DIESEL PD TDI - 1.2, 1.4, 1.9, 2.0

VAG diesel engine timing tool master kit offered specifically for the applications listed on our website. Designed to allow the replacement of the camshaft drive belts found on the popular VAG diesel engines from 1999 to 2015.

COMPONENTS

REF	ART. NO.	OEM	DESCRIPTION
1	4880250	E10347 04	Dia. 4.0mm tensioner pin
2	4880251	E10347 07	Dia. 7.0mm tensioner pin
3	4880274	T10115	Locking pin
4	4880092	T20102, 3359	Injection pump timing pin
5	4880093	T10008	Tensioning tool (zinc PL. Y)
6	4880140	T10050	Crankshaft locking tool
7	4880141	T10100	Crankshaft alignment tool
8	4880157	T10060	Tensioner pin
9	4880195	T40098	Tensioner pulley locking pin assembly [T40098]
10	4880196	T10265	Tensioner pulley locking pin assy Ø2.5. [T10265]
11	4880197	T10264	6mm ball end hex key
12	4880252	E10347 08	Dia. 8.0mm tensioner pin
13	4880017	T10020 / V.159	Tensioner
14	4880016	T10020 / 2287	Tension wrench

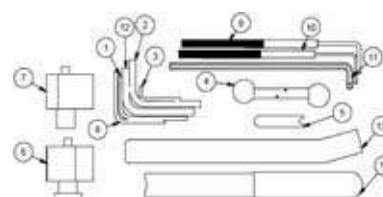

VAG - AUDI - VOLKSWAGEN



829078 - ENGINE TIMING KIT VAG PETROL, DIESEL - 1.7, 1.9 (DIESEL), 1.6, 2.0 (PETROL)

VAG combination kit

COMPONENTS

REF	ART. NO.	OEM	DESCRIPTION
1	4880017	T10020	Tensioner
2	4880015	2587, MatraV159	Tension wrench
3	4880081	2065A	Setting bracket (zinc PL.)
4	4880142	-	M5 x 60 HT setscrew S/Col
5	4880158	T10098	Camshaft setting bracket
6	4880092	T20102, 3359	Injection pump timing pin
7	4880071	2064	Setting spigot (chem. black) (pin 15.5 x 67)
8	4880144	T40011	Tensioner locking pin 1.4mm bzp & clear passivate
9	4880143	-	Stud and nut assembly
10	4880155	T10092	Tensioner bolt
11	4880154	T20018, 3366, T20044	Chain tensioner retainer

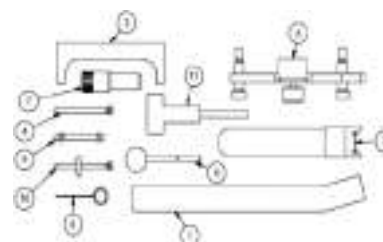

VAG - AUDI - VOLKSWAGEN



829090 - CAMBELT TENSIONER WRENCH VAG 30MM PETROL - 1.0, 1.2, 1.4

A 12 point (double Hex) 30 mm cam belt tensioner wrench intended for use on VAG vehicles as listed on our website. The 829090 VAG tension wrench is designed to allow the user to adjust the camshaft drive belt tensioner in the manor described by the manufacturer. The 829090 is specifically designed for use on the latest range of 1.0lt, 1.2lt and 1.4lt belt driven petrol turbo charged petrol engines.

Equivalent to OEM T10499

COMPONENTS

REF	ART. NO.	OEM	DESCRIPTION
1	829090	T10499	Cam belt tensioner wrench VAG 30mm petrol - 1,0/1,2/1,4

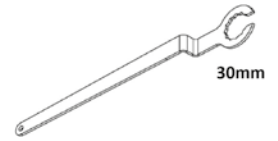

VAG - AUDI - VOLKSWAGEN

829092 - AUXILLIARY DRIVE BELT WRENCH PETROL TFSI 16MM VAG - 1.4

A 16.0 mm across flats spanner with PVC handle intended for use on VAG vehicles (predominantly Volkswagen) utilising the 1.4 TFSI engines. The cranked spanner is required for releasing tension on the auxiliary drive belt, which is achieved by rotating the engines' spring loaded belt tensioner away from the belt.

Equivalent to OEM T10447

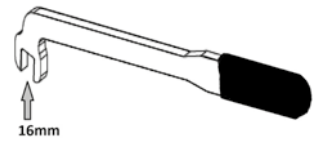
COMPONENTS

REF	ART. NO.	OEM	DESCRIPTION
1	829092	T10447	Auxiliary Drive Belt Wrench Petrol TFSI 16mm VAG - 1,4

VAG - AUDI - VOLKSWAGEN

829093 - TIMING CHAIN TENSIONER LEVER VAG PETROL TFSI - 1.8/2.0

The 829093 is a specially designed tensioner lever for later generation III 1.8 & 2.0 4v TFSI engines. This one piece lever allows the user to push back the timing chain tensioner without removing the front engine cover. The 829093 is the Sonic equivalent to the VAG original equipment number T40243.

COMPONENTS

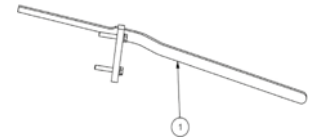
REF	ART. NO.	OEM	DESCRIPTION
1	829093	T40243	Timing Chain Tensioner Lever VAG Petrol TFSI - 1,8/2,0

VAG - AUDI - VOLKSWAGEN

829099 - CAM BELT TENSIONER WRENCH VAG, VOLVO 32MM DIESELS TDI - 2.5

The 829099 is a 32mm multi hex wrench designed to fit the tensioner used on the VAG 2.5 TDI/SDi diesel engines. Equivalent to OEM number 3355.

COMPONENTS

REF	ART. NO.	OEM	DESCRIPTION
A	4880146	3355, 999 5649, 999-5649	32mm. hex wrench tensioner pulley

VAG - AUDI - VOLKSWAGEN

829100 - CAM BELT TENSIONER WRENCH VAG ADJUSTABLE HEAD

The 829100 is an adjustable cam-belt tensioner tool. Equivalent to EOM T10020 and Matra V159.

COMPONENTS

REF	ART. NO.	OEM	DESCRIPTION
1	829100	T10020//Matra V159	Cam belt tensioner wrench VAG adjustable head

VAG - AUDI - VOLKSWAGEN

829103 - FRONT PANEL GUIDE SET VW T5 VAN

829103 allows the user to space the front of the T5 van off away from the front of the vehicle without disconnecting all the front panel pipe work saving significant time and ensuring the panel does not fall so preventing damage. Screw in place of main front panel mounting pins. Supplied as a set of 4.

COMPONENTS

REF	ART. NO.	OEM	DESCRIPTION
A	4880306	T10288	VW (2004 - onwards) T5 front body panel guide pin assy

VAG - AUDI - VOLKSWAGEN

Sonic timing tools

829108 - CAM BELT TENSIONER TOOL SET VAG TDI - 1.9, 2.0

The 829108 used during timing belt replacement on Volkswagen 1.9/2.0 TDi PD SOHC, 4 cylinder diesel engines where there is restricted access to the tensioner pulley rollers due to the modified sub-frame mountings.

COMPONENTS

REF	ART. NO.	OEM	DESCRIPTION
1	4880197	T10264	6 mm ball end hex key
2	4880196	T10265	Tensioner pulley locking pin assy Ø2.5. [T10265]
3	4880195	T40098	Tensioner pulley locking pin assembly [T40098]

VAG - AUDI - VOLKSWAGEN



829109 - WATER PUMP PULLER KIT VAG DIESEL - 2.5

The 829109 Water pump puller tool set is equivalent to the OEM tools required to remove the water pump and water pump pulley on the VAG 2.5 diesel engines found in the VW T5 van and Touareg vehicles.

COMPONENTS

REF	ART. NO.	OEM	DESCRIPTION
1	4880164	T10225	Special wrench VAG
2	4880163	T10221A	Puller VAG T10221
3	4880166	T10222A	Water pump tool

VAG - AUDI - VOLKSWAGEN



829115 - ENGINE TIMING TOOL SET - VAG 1,4/1,6/2,0I TDI CR

The 829115 is a comprehensive kit for removal and fitting of the camshaft drive belt on the popular 1.4, 1.6 and 2.0 VAG TDi CR diesel engines found across the VAG ranges from 2012. The engines covered utilise a belt with transfer gears in the head. Included in the kit are the pins required for timing the camshafts in the head, updated for 2018.

COMPONENTS

REF	ART. NO.	OEM	DESCRIPTION
1	4880196	T10265	Tensioner pulley locking pin assy Ø2.5. [T10265]
2	4880197	T10264	6mm ball end hex key
3	4880413	T10409	8mm hex key
4	4880308	T10492	6mm locking pin
5	4880157	T100600A	Tensioner pin
6	4880096	T10490	Locking pin (8mm dia. 70 long)
7	4880304	T10490	Machined plate for crankshaft positioning/holding tool
8	4880152	T10051	Pulley holding tool g.A vag

VAG - AUDI - VOLKSWAGEN

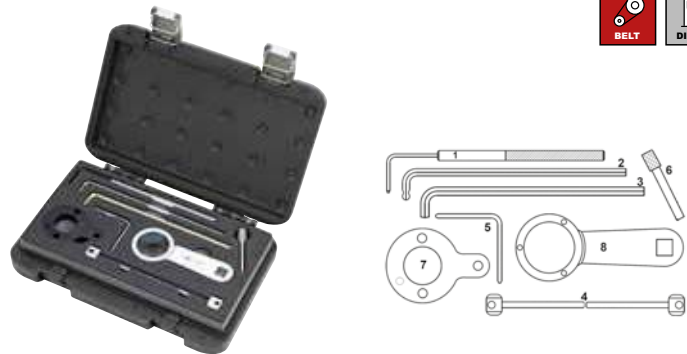

829117 - ENGINE TIMING KIT VAG/PORSCHE

The 829117 timing tool kit provides the essential camshaft, crankshaft and petrol fuel pump alignment tools to allow replacement of the camshaft drive chain on the 2001 to 2015 6 and 8 cylinder FSI petrol engines found in the VAG and Porsche ranges.

COMPONENTS

REF	ART. NO.	OEM	DESCRIPTION
1	4880360	T10068-A	Camshaft alignment plate x 2
2	4880361	T10069	Crankshaft pulley holding tool
3	4880407	T40237	Crankshaft TDC locking screw
4	4880362	T10363	Fuel pump sprocket locking tool (with mechanical vacuum pump)
5	4880363	T10332	Fuel pump sprocket locking tool (no mechanical vacuum pump)

VAG - AUDI - VOLKSWAGEN

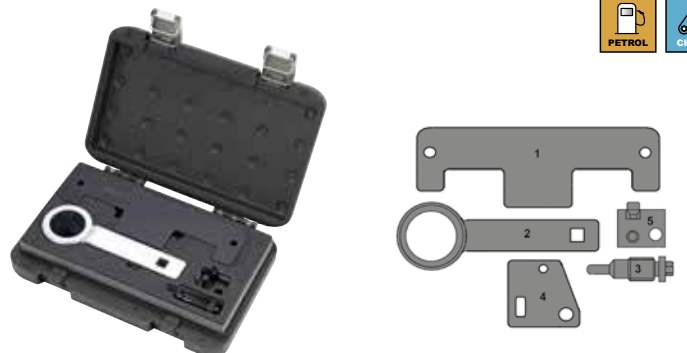

829118 - FUEL PUMP DRIVE BELT KIT - VAG TDI 2,7/3,0

829118 has been developed specifically for the VAG 2.7L and 3.0L TDI diesel engines from 2007 that are equipped with a belt driven high pressure diesel pump. The kit contains all the components to allow the removal and replacement of the pump belt while maintaining the pump and engine timing. Component equivalent to OEM tools - T40135, 3242, T10320, T40058.

COMPONENTS

REF	ART. NO.	OEM	DESCRIPTION
1	4880364	T40135	High pressure pump locking tool
2	4880407	3242/T40237	Crankshaft tdc locking screw
3	4880365	T10320	Camshaft sprocket puller
4	4880156	T40058	Pulley bolt

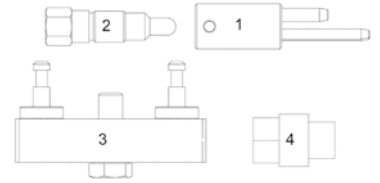
VAG - AUDI - VOLKSWAGEN

829122 - VIBRATION DAMPER HOLDING TOOL - 1,8/2,0 TFSI/TSI

A comprehensive kit used for dismantling and assembling the vibration damper on the applications listed. The vibration damper fitted to the VAG 1.8 | 2.0 TFSI | TSI engines is held in place by a single central bolt. The pulley clamps the crankshaft timing chain sprocket against the end of the crankshaft, there is no traditional key way and the sprocket is not supported by the crankshaft. If the pulley bolt is removed without using the 829122 the crankshaft chain sprocket can easily separate from the crankshaft causing the timing position to be lost. The 829122 is an essential kit required to maintain the engine timing when removing the front vibration damper and should be used whenever the vibration damper is removed for instance when replacing the front crankshaft oil seal. N.B. for replacement of the camshaft drive chain additional tooling will be required - see Sonic Equipment 829066 Engine Timing Kit. The 829122 can also be used on earlier engines as the VW tool T10531 replaces the older tool T10368.

COMPONENTS

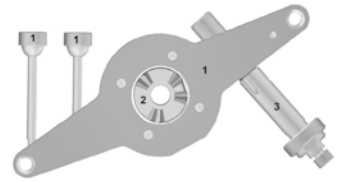
REF	ART. NO.	OEM	DESCRIPTION
1	4880382	T10531/1	Vibration damper holding tool
2	4880383	T10531/3	Crankshaft sprocket holding tool adapter
3	4880384	T10531/4 & T10531/2	Crankshaft sprocket holding tool nut

VAG - AUDI - VOLKSWAGEN

829123 - CRANKSHAFT HOLDING TOOLS WRENCH - VAG

The 829123 has been designed to hold the crankshaft pulley while loosening or tightening the crankshaft centre bolt. The tool has a short handle for easy storage with a 1/2" D square to allow use with a power bar to extend the effective handle length. Double sided tool for tightening and loosening the fixing bolts.

COMPONENTS

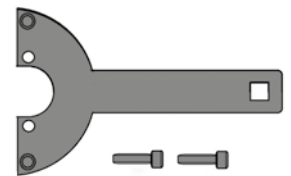
REF	ART. NO.	OEM	DESCRIPTION
1	829123	3415 & 3415/1	Crankshaft Holding Tools Wrench - VAG

VAG - AUDI - VOLKSWAGEN

829125 - CAMSHAFT ALIGNMENT KIT VAG 1,4TFSI

The 829125 timing tool kit provides the essential camshaft and crankshaft setting tools to allow replacement of the camshaft drive belt on the new (2012 onwards) VAG 1.4 TFSI petrol engines.

COMPONENTS

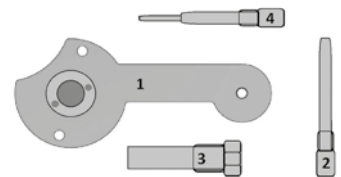
REF	ART. NO.	OEM	DESCRIPTION
1	4880386	T10504	Camshaft positioning tool - EU registered design
2	4880388	T10504/1	Camshaft timing pin
3	4880199	T10320	Locking pin (T10340)
4	4880387	T10504/2	Camshaft timing check pin

VAG - AUDI - VOLKSWAGEN

Sonic timing tools

829129 - ENGINE TIMING TOOL KIT - AUDI RS3, Q3, TT 2,5

The 829129 timing tool kit provides the essential camshaft, crankshaft setting tools and camshaft adjuster holding tool to allow replacement of the camshaft drive chains on the 2.5 TFSI 5 cylinder petrol engines found in the Audi TT and RS3 models.

COMPONENTS

REF	ART. NO.	OEM	DESCRIPTION
1	4880160	T40070	Camshaft alignment tool VAG T40070
2	4880212	Bolts M8 X 50mm Din 931	M8 x 50 LG bolt DIN 931
3	4880274	T03006	Locking pin
4	4880400	T03003	Crankshaft pulley bolt adapter
5	4880161	T40069	TDC alignment pin vag T40069
6	4880399	T40079	Camshaft adjuster holding tool



VAG - AUDI - VOLKSWAGEN

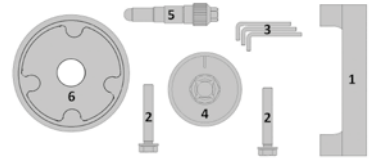

829044 - ENGINE TIMING KIT FORD/VOLVO PETROL - 1.25, 1.4, 1.6, 1.8, 2.0

The 829044 kit has been developed specifically for late Ford 1.25lt, 1.4lt, 1.6lt, petrol engines. Coverage also includes some 1.8lt, 2.0lt & 2.3lt engines

COMPONENTS

REF	ART. NO.	OEM	DESCRIPTION
1	4880049	21-163, 303-574	Crankshaft locking pin - Ford (chem. black)
2	4880051	21-210, 303-507	Mazda screw
3	4880052	21-259, 303-748	Setting pin (chem. black)
4	4880274	303-1054	Locking pin
5	4880050	303-376B	Camshaft alignment strap (chem. black)



VOLVO

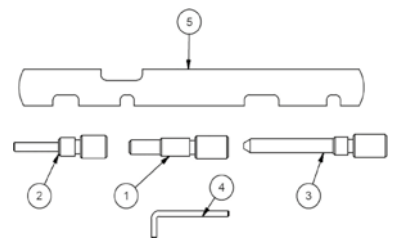

829048 - ENGINE TIMING KIT FORD, VOLVO SCTI ECOBOOST PETROL - 1.6

The 829048 kit has been developed specifically for the 1.6 direct injection petrol engines fitted with variable valve timing and found in both the Ford and Volvo ranges. 829048 is a 4 piece kit consisting of the components required to lock the crankshaft and cam pulleys in their timed position to allow the removal and replacement of the camshaft timing belt. The 829048 also includes the crankshaft front pulley alignment tool.

COMPONENTS

REF	ART. NO.	OEM	DESCRIPTION
1	4880249	303-1054	Dia. 3.0mm tensioner pin
2	4880270	303-1550, 999-7431	Ford 1.6 ecoboost crankshaft pulley alignment Tool assembly
3	4880049	303-748, 999-7406	Crankshaft locking pin - Ford (chem. black)
4	4880069	303-1097, 999-7429	Camshaft sprocket locking tool 303-1097



VOLVO

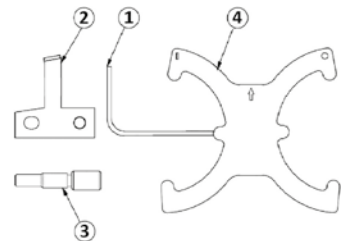

829079 - ENGINE TIMING KIT VOLVO DIESEL 5 CYLINDER - 2.0, 2.4

The 829079 kit provides all the essential engine timing tools to set and lock the engine components of the popular Volvo 2.0lt and 2.4lt 5 cylinder diesel engines to allow camshaft belt replacement.

• Additional recommended tooling – Sonic recommends the use of Sonic 829089 crankshaft pulley holding tool when tightening or loosening the crankshaft pulley fixing bolt.

COMPONENTS

REF	ART. NO.	OEM	DESCRIPTION
1	4880272	999-7005	Volvo crankshaft timing pin (999-7005)
2	4880271	999-7007	Volvo camshaft timing pin (999-7007)
3	4880096	999-7122	Locking pin (8mm dia. 70 long)
4	4880097	999-7169	Locking pin (8mm dia x 60)
5	4880068	999-7121	Timing pin
6	4880106	999-7120	Flywheel lock (zinc PL.)
7	4880061	999-7119	Flywheel locking tool-Ford
8	-	999-7119	Tooth block for reference 7
9	4880332	-	M8 x 20 H.T. setscrew
10	4880047	-	Washer M8 zinc plated
11	4880197	-	6mm ball end hex key
12	4880090	999-7233	Setting pin 5.0mm [5 x 50]



VOLVO

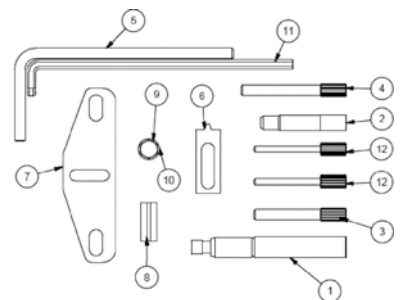

829080 - ENGINE TIMING KIT VOLVO PETROL GTDI - 2.0

The 829080 is a 6 piece engine timing kit designed for the Volvo 2.0 direct injection petrol engines found in Volvo vehicles from 2010. Developed to allow the timing chain to be replaced whilst locking the crankshaft and camshafts in their correct timed positions. The 829080 also includes the special Volvo type crankshaft position sensor alignment tool.

VOLVO

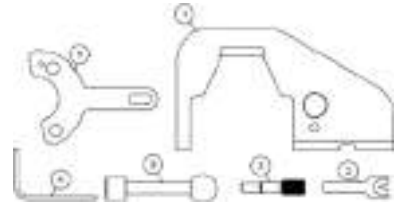

COMPONENTS

REF	ART. NO.	OEM	DESCRIPTION
1	4880245	999 7405, 303-1504	Ford GTDI M14 camshaft alignment tool assy
2	4880290	999 7416	Volvo 2.0 GTDI CKP sensor alignment tool
3	4880049	999 7406, 303-748	Crankshaft locking pin - Ford (chem. black)
4	4880249	-	Dia. 3.0mm tensioner pin
5	4880289	999 7415	Volvo 2.0 GTDI position setting tool

829081 - ENGINE TIMING KIT VAG PETROL 3 CYLINDER - 1.0

The 829081 kit has been developed specifically for the 1.6 D Volvo drive/D2 engines. 829081 is a 3 piece kit consisting of the components required to lock the crankshaft, crank pulley and the cam pulley in their timed position to allow the removal and replacement of the camshaft timing belt. Whilst the 829081 has been specifically put together to cover the latest generation 1.6 diesel engines from Volvo, the kit includes components that are also relevant to earlier Ford engines.

VOLVO



COMPONENTS

REF	ART. NO.	OEM	DESCRIPTION
1	4880064	303-734, 999-7169	Flywheel locking pin (12 x 55)
2	4880096	303-735, 999-7122	Locking pin (8mm dia. 70 long)
3	4880090	303-732, 999-7121	Setting pin 5.0mm (5 x 50)

829082 - ENGINE TIMING KIT RENAULT, VOLVO PETROL TWIN CAM 16V/20V - 2.0, 2.4

The 829082 kit provides all the essential engine timing tools to set and lock the engine components of the popular Renault/Volvo 2.0lt and 2.5lt petrol engines to allow camshaft belt replacement. Also offers coverage for the 1.6, 1.8, 1.9 and 2.3 derivatives. See attached applications.
 • Additional recommended tooling - Sonic recommends the use of Sonic 829089 crankshaft pulley holding tool when tightening or loosening the crankshaft pulley fixing bolt.

VOLVO

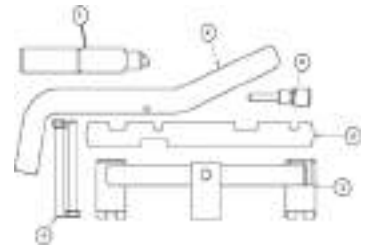

COMPONENTS

REF	ART. NO.	OEM	DESCRIPTION
1	4880101	MOT 1340, 999 5451	Timing pin
2	4880105	MOT 1348	Tensioning tool (no sleeve)
3	4880107	MOT 1337, 999 5452	Camshaft setting tool
4	4880051	303-507, 999 7152	Mazda screw
5	4880050	303-376B	Camshaft alignment strap (chem. black)
6		-	Hex-head bolt for 3

829089 - CAMSHAFT SETTING TOOL VOLVO/FORD

The 829089 is designed to hold the front crankshaft pulley while tightening or loosening the pulley fixings across the Volvo range of engines and the Ford 2.5 petrol engine found in the ST Focus etc.

VOLVO



COMPONENTS

REF	ART. NO.	OEM	DESCRIPTION
1	829089	999 5433, 303-1179	Crankshaft holding tool Volvo/Ford

829099 - CAM BELT TENSIONER WRENCH VAG, VOLVO 32MM DIESELS TDI - 2.5

The 829099 is a 32mm multi hex wrench designed to fit the tensioner used on the VAG 2.5 TDI/SDi diesel engines. Equivalent to OEM number 3355.

VOLVO



COMPONENTS

REF	ART. NO.	OEM	DESCRIPTION
A	4880146	3355, 999 5649, 999-5649	32mm. hex wrench tensioner pulley

Sonic timing tools

829133 - ENGINE SERVICE LIT VOLVO/FORD 2,5 PETROL

Developed specifically for the 2.5 DOHC petrol engines used by Ford and Volvo.
 • The kit contains all of the components to allow the camshafts to be held in the correct position whilst setting the tappets and for replacement of the front crankshaft oil seal.

VOLVO



COMPONENTS

REF	ART. NO.	OEM	DESCRIPTION
1	4880411	303-1183,999 5765	Camshaft holding bracket - base
2	4880410	303-1183	Camshaft holding bracket - clamp
3	4880412	303-1183	Camshaft holding bracket - connecting piece
4	4880349	303-1183	M10 x 15lg caphead screw to ISO 4762
5	4880351	-	M6 x 40 screws
6	4880214	-	M6 x 50 caphead screw
7	4880408	303-1180	Crankshaft seal fitting drift
8	4880409	303-1180	Crankshaft seal fitting guide

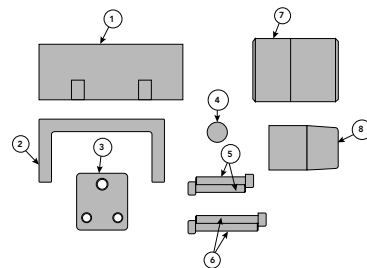

829096 - DIESEL INJECTION PUMP TIMING KIT BOSCH/NIKI/NIPPON DENSO/LUCAS CAV

The 829096 tool kit is required when setting up Bosch EP/VE Rotary, Nikki, Nippon Denso, CAV roto-diesel injection pumps (top entry port) and the PSA XUD range of engines.

UNIVERSAL



COMPONENTS

REF	ART. NO.	OEM	DESCRIPTION
1	4880083		Adaptor assy zinc
2	4880084		DTI extension item 3
3	4880085		Connector (chem. black)
4	4880086		M14 adaptor assembly
5	4880087		Plunger
6	4880088	999 5382	Probe assembly
7	4880089	999 5382	DTI/CAV mounting bracket
8	4880124		Adaptor M8 short assy.
9	4880125		Dti extension item 2
10	4880126		Adaptor M10 short
11	4880123	KM 571A, 3313	DTI -ORD. style c/w test cert.

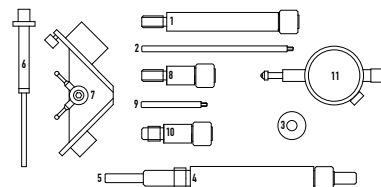

829098 - SPROCKET HOLDING TOOL UNIVERSAL

The 829098 is a sprocket holding wrench used to tighten and loosen camshaft sprockets to prevent damage to timing pins and camshafts.

UNIVERSAL



COMPONENTS

REF	ART. NO.	OEM	DESCRIPTION
1	829098	6016T, 1 860 831 000, 1 860 885 000, 1 842 128 000, 15-030A, MOT 799, MPI-216, 3036, 5199, 1 822 146 000, 1 822 155 000, 205-072, U20002, 999 5645, 999-5199, 999-5705, 15-30-A, 15-030-A, MP1-216, 999 5199, 999-5645, 999 5705, 9880, MB990767, UN205 072, 0132-AA	Sprocket holding tool - universal

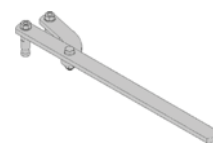

ALWAYS A SOLUTION

With our **accurate timing tool database**, which is supported and run by Auto Data, you can **find the right tool** for any job by searching: OE number, vehicle selection or engine code.



SONIC

SONIC TIMING TOOLS SEARCH ENGINE

We would like to help you find the right timing tool for the job. Complete the fields below to view a list of timing tools required for your vehicle and where possible Sonic tool sets that meet your requirements.

Make:	<input type="text"/>	-	Know the engine code or OEM-number of your vehicle?
Model:	<input type="text"/>	-	Fill in the fields below to get a list of Timing Tools.
Year:	<input type="text"/>	-	
Engine size:	<input type="text"/>	-	Engine code: <input type="text"/>
Engine code:	<input type="text"/>	-	OEMToolcode: <input type="text"/>

FIND TOOL

RESET



**WORK
EFFICIENT
WORK
WITH SONIC**



SONIC DISPLAYS

Further improve your appearance
and sales rotation.

Sonic displays

709404 - DISPLAY 1 MTR. WITH 94 ITEMS (TOOLS ONLY)

TOOLS	ART. NO.	CONTENTS
	100904	1 Bit socket set 1/4", hex on rail, 9-pcs
	101001	1 Socket set 1/4", on rail, 10-pcs
	101002	1 Socket set 1/4", TX on rail, 10-pcs
	101004	1 Bit socket set 1/4", TX on rail, 10-pcs
	104602	1 Combination set 1/4", 46-pcs BMCS
	1310...2	3 Screwdriver PH, PH.0, PH.1, PH.2
	13303...65	3 Screwdriver slotted, 3, 4, 6, 5mm
	201001	1 Socket set 3/8", on rail, 10-pcs
	201002	1 Socket set 3/8", TX on rail, 10-pcs
	201003	1 Bit socket set 3/8", hex on rail, 10-pcs
	201005	1 Bit socket set 3/8", TX on rail, 10-pcs
	203703	1 Socket set & wrench set 3/8", 37-pcs BMCS
	206102	1 Socket & bit socket set 3/8", 61-pcs BMCS
	300902	1 Socket set 1/2", TX-E on rail, 9-pcs
	301003	1 Bit socket set 1/2", hex on rail, 10-pcs
	301005	1 Bit socket set 1/2", TX on rail, 10-pcs
	301201	1 Socket on rail, 1/2", 12 pt.cs
	309402	1 Socket set 1/4" & 1/2", 94-pcs BMCS
	3310115...22	5 Wheel socket 1/2", 6 pt. 15, 17, 19, 21, 22mm
	3358513...22	9 Deep impact socket 1/2", 6 pt. 13, 17, 19, 21, 22, 24, 27, 30, 32mm
	3397824	1 Deep impact socket 1/2", 12 pt. 24mm
	41506...24	16 Combination wrench 6, 7, 8, 9, 10, 11, 12, 13, 14, 15, 16, 17, 19, 21, 22, 24mm
	4170208...19	5 Reversible ratcheting wrench 12 pt. 8, 10, 13, 17, 19mm
	42301250	1 Adjustable wrench 10"
	4311175	1 Combination pliers 7"
	4321200	1 Long nose pliers 8"
	4331200	1 Bent long nose pliers 8"
	4341175	1 Diagonal pliers 7"
	4351250	1 Waterpump pliers 10"
	4380250	1 Locking pliers 10"
	4611400	1 Machinist hammer with ash handle, 512gr
	4620400	1 Install hammer soft/hard, with ash handle, 608gr
	4631000	1 Stoning hammer with ash handle, 1106gr
	46806	1 Utility knife (incl. 10 blades)
	47013	1 Measuring tape 5 meter
	47022	1 Volt circuit tester 6-24V
	47537	1 Flexible hex nut driver, 7mm
	47903	1 Scraper
	600618	1 Screwdriver set in colored box, 6-pcs
	600619	1 Screwdriver set TX in colored box, 6-pcs
	600620	1 Screwdriver set TX-H in colored box, 6-pcs
	600902	1 TX key set extra long, 9-pcs
	601008	1 Hex ball key set extra long, 10-pcs
	601702	1 Combination wrench set in pouch, 17-pcs
	multi 602006	1 Screwdriver set, 20-pcs



	-	7110301	1	Disc ratchet 1/4", 72 teeth
	-	7110302	1	Disc ratchet 3/8", 72 teeth
	-	7120901	1	Ratchet 1/4", 45 teeth
	-	7120902	1	Ratchet 3/8", 45 teeth
	-	7120903	1	Ratchet 1/2", 45 teeth
	-	7133250	1	Sliding T-handle 1/2"
	-	7141050...150	2	Extension 1/4", 50mm, 150mm
	-	7142075...150	2	Extension 3/8", 75mm, 150mm
	-	7143125...250	2	Extension 1/2", 125mm, 250mm
	-	71511	1	Universal joint 1/4"
	-	71521	1	Universal joint 3/8"
	-	71531	1	Universal joint 1/2"
	-	7172216...21	3	Spark plug 3/8" clip socket 16, 18, 21mm
	-	7232200	1	Swivel handle 3/8", 200mm

FOR A COMPLETE INVENTORY ORDER LIST SEE OUR WEBSITE



724704 - DISPLAY 2 MTR. WITH 247 ITEMS (TOOLS ONLY)

TOOLS	ART. NO.	CONTENTS
	100904	1 Bit socket set 1/4", hex on rail, 9-pcs
	101001	1 Socket set 1/4", on rail, 10-pcs
	101002	1 Socket set 1/4", TX on rail, 10-pcs
	101004	1 Bit socket set 1/4", TX on rail, 10-pcs
	- 104602	1 Combination set 1/4", 46-pcs BMCS
	- 12425008...10	2 Hex nut driver 8, 10mm
	1310...3	4 Screwdriver PH, PH.0, PH.1, PH.2, PH.3
	13303...08	6 Screwdriver slotted, 3, 3.5, 4, 5, 5.5, 6.5, 8mm
	13610...40	7 Screwdriver TX, T10, T15, T20, T25, T27, T30, T40
	14423008...10	2 Hex nut driver T-handle 8, 10mm
	201001	1 Socket set 3/8", on rail, 10-pcs
	201002	1 Socket set 3/8", TX on rail, 10-pcs
	201003	1 Bit socket set 3/8", hex on rail, 10-pcs
	201005	1 Bit socket set 3/8", TX on rail, 10-pcs

TOOLS	ART. NO.	CONTENTS
	- 203703	1 Socket & wrench set 3/8", 37-pcs BMCS
	- 206102	1 Socket & bit socket set 3/8", 61-pcs BMCS
	21504...13	10 Flank socket 1/4", 6 pt. 4, 5, 6, 7, 8, 9, 10, 11, 12, 13mm
	2155004...13	11 Flank deep socket 1/4", 6 pt. 4, 5, 5.5, 6, 7, 8, 9, 10, 11, 12, 13mm
	21555	1 Flank socket 1/4", 6 pt. 5.5mm
	21608...10	2 Socket 1/4", TX E8, E10
	2165008...10	2 Deep socket 1/4", TX E8, E10
	22507...22	14 Flank socket 3/8", 6 pt. 7, 8, 10, 11, 12, 13, 14, 15, 16, 17, 18, 19, 21, 22mm
	2256307...19	12 Flank deep socket 3/8", 6 pt. 7, 8, 10, 11, 12, 13, 14, 15, 16, 17, 18, 19mm
	23510...27	16 Flank socket 1/2", 6 pt. 10, 11, 12, 13, 14, 15, 16, 17, 18, 19, 20, 21, 22, 23, 24, 27mm
	2357710...30	13 Flank deep socket 1/2", 6 pt. 10, 12, 13, 14, 15, 16, 17, 18, 19, 21, 22, 24, 30mm
	- 300817	1 Bit socket set 1/2", TX 8-pcs BMCS
	- 300818	1 Bit socket set 1/2", TX 8-pcs BMCS
	300902	1 Socket set 1/2", TX on rail, 9-pcs

TOOLS	ART. NO.	CONTENTS
	301003	1 Bit socket set 1/2", hex on rail, 10-pcs
	301005	1 Bit socket set 1/2", TX on rail, 10-pcs
	301201	1 Socket set 1/2" 12 pt. on rail, 12pcs
	304201	1 Bit set 10mm 42-pcs
	309402	1 Socket set in suitcase 94-pcs BMCS
	309901	1 Socket set in suitcase 99-pcs BMCS
	331015...19	3 Wheel socket 1/2", 15, 17, 19mm
	3358513...32	10 Deep impact socket 1/2", 6 pt. 13, 15, 17, 19, 21, 22, 24, 27, 30, 32mm
	3397824...27	2 Deep impact socket 1/2", 12 pt. 24, 27mm
	3398534...36	3 Deep impact socket 1/2" 12 pt. 34, 35, 36mm
	41506...32	21 Combination wrench 6, 7, 8, 9, 10, 11, 12, 13, 14, 15, 16, 17, 18, 19, 20, 21, 22, 24, 27, 30, 32mm
	4170208...19	11 Reversible ratcheting wrench 12 pt. 8, 10, 11, 12, 13, 14, 15, 16, 17, 18, 19mm
	4311175	1 Combination pliers 7"
	4321200	1 Long nose pliers 8"
	4331200	1 Bent long nose pliers 8"
	4341175	1 Diagonal pliers 7"
	4351250	1 Waterpump pliers 10"
	4380250	1 Locking pliers 10"
	4450300	1 Oil filter pliers 12"
	4471250	1 Wire stripper 10"
	45110141	1 Grip chisel 140mm 10
	45112160	1 Grip chisel 160mm 12
	45118190	1 Grip chisel 190mm 18
	45124220	1 Grip chisel 220mm 24
	4527190	1 Grip cape chisel 190mm 7"
	4533150	1 Grip pin punch 150mm 3"
	4534180	1 Grip pin punch 180mm 4"
	4535200	1 Grip pin punch 200mm 5"
	4536210	1 Grip pin punch 210mm 6"
	4564185	1 Grip center punch 185mm 4"
	4611400	1 Machinist hammer with ash handle, 512gr
	4620400	1 Install hammer soft/hard, with ash handle, 608gr
	4631000	1 Stoning hammer with ash handle, 1106gr
	46807	1 Utility knife (incl. 3 blades)
	47002	1 Feeler gauge 26-pcs
	47013	1 Measuring tape 5 meter
	47022	1 Volt circuit tester 6-24V
	47537	1 Flexible hex nut driver, 7mm
	47902	1 Door upholstery panel remover 110mm
	47903	1 Scraper
	4820110	1 Telescopic magnet
	4820514	1 Rechargeable COB work light 2W
	4820515	1 MAG work light
	4820517	1 Work lamp with top flash light
	4831101	1 Flat chisel 240mm 26"
	600618	1 Screwdriver set in colored box, 6-pcs
	600619	1 Screwdriver set TX in colored box, 6-pcs
	600620	1 Screwdriver set TX-H in colored box, 6-pcs
	600813	1 Foldable TX key set, 8-pcs
	600902	1 TX key set extra long, 9-pcs
	601001	1 16 in 1 ratchet screwdriver
	601006	1 Hex ball long key set 10-pcs

TOOLS	ART. NO.	CONTENTS
	601008	1 Hex ball key set extra long, 10-pcs
	601219	1 Reversible ratcheting wrench 12 pt. in pouch, 12-pcs
	601401	1 Combination wrench set in pouch, 14-pcs
	601702	1 Combination wrench set in pouch, 17-pcs
	multi 602006	1 Screwdriver set, 20-pcs
	7110101	1 Flexible ratchet 1/4", 45 teeth
	7110202	1 Rotor ratchet 3/8", 72 teeth
	7110301	1 Disc ratchet 1/4", 72 teeth
	7110302	1 Disc ratchet 3/8", 72 teeth
	7120701	1 Ratchet 1/4", 72 teeth
	7120901	1 Ratchet 1/4", 45 teeth
	7120902	1 Ratchet 3/8", 45 teeth
	7120903	1 Ratchet 1/2", 45 teeth
	7133250	1 Sliding T-handle 1/2"
	7141050...150	2 Extension 1/4", 50mm, 150mm
	7142075...150	2 Extension 3/8", 75mm, 150mm
	7143125...250	2 Extension 1/2", 125mm, 250mm
	71511	1 Universal joint 1/4"
	71521	1 Universal joint 3/8"
	71531	1 Universal joint 1/2"
	7172216...21	3 Spark plug clip socket 3/8", 16, 18, 21mm
	7174214	1 Spark plug socket 12 pt. 3/8", 14mm (90mm)
	7175214	1 Spark plug socket 12 pt. 3/8", 14mm (250mm)
	7232200	1 Swivel handle 3/8", 200mm
	73220550	1 Torque wrench 3/8", 5-50Nm
	732320200	1 Torque wrench 1/2", 20-200Nm
	801018	1 Brake caliper service set, 18-pcs
	813003	1 Wire stripper 0.2-6.0mm 200L

FOR A COMPLETE INVENTORY ORDER LIST SEE OUR WEBSITE



09

737404 - DISPLAY 3 MTR. WITH 374 ITEMS (TOOLS ONLY)













TOOLS	ART. NO.	CONTENTS
	101002	1 Socket set 1/4", TX on rail, 10-pcs
	101004	1 Bit socket set 1/4", TX on rail, 10-pcs
	104602	1 Combination set 1/4", 46-pcs BMCS
	1310...13	4 Screwdriver PH, PH.0, PH.1, PH.2, PH.3
	13303...08	6 Screwdriver slotted, 3, 3.5, 4, 5.5, 6.5, 8mm
	13610...30	6 Screwdriver TX, T10, T15, T20, T25, T27, T30
	14423008...10	2 Hex nut driver T-handle 8, 10mm
	1950203...04	2 Hex ball point grip key 3, 4mm
	201001	1 Socket set 3/8", on rail, 10-pcs
	201002	1 Socket set 3/8", TX on rail, 10-pcs
	201003	1 Bit socket set 3/8", hex on rail, 10-pcs
	201005	1 Bit socket set 3/8", TX on rail, 10-pcs
	201006	1 Bit socket set 3/8", TX-H on rail, 10-pcs
	201201	1 Bit socket set 3/8", ribe & spline on rail, 12 pt. 12-pcs
	203703	1 Socket & wrench set 3/8", 37-pcs BMCS
	206102	1 Socket & bit socket set 3/8", 61-pcs BMCS
	21555...13	7 Flank socket 1/4", 6 pt. 5.5, 6, 7, 8, 10, 12, 13mm
	2155006...13	5 Flank deep socket 1/4", 6 pt. 6, 7, 8, 10, 13mm
	22507...19	12 Flank socket 3/8", 6 pt. 7, 8, 10, 11, 12, 13, 14, 15, 16, 17, 18, 19mm
	2256308...19	11 Flank deep socket 3/8", 6 pt. 8, 10, 11, 12, 13, 14, 15, 16, 17, 18, 19mm
	22608...18	7 Socket 3/8", TX E8, E10, E11, E12, E14, E16, E18
	23510...32	18 Flank socket 1/2", 6 pt. 10, 11, 12, 13, 14, 15, 16, 17, 18, 19, 20, 21, 22, 24, 27, 28, 30, 32mm

TOOLS	ART. NO.	CONTENTS
	2357710...30	13 Flank deep socket 1/2", 6 pt. 10, 12, 13, 14, 15, 16, 17, 18, 19, 21, 22, 24, 30mm
	300603	1 Adaptor set 6-pcs
	300817	1 Bit socket TX set 1/2", 8-pcs BMCS
	300818	1 Bit socket TX long set 1/2", 8-pcs BMCS
	300902	1 Socket 1/2", TX-E set on rail, 9-pcs
	301007	1 Socket set on rail, 1/2", 10-pcs
	304201	1 Bit set 10mm 42-pcs
	309402	1 Socket set 1/4" & 1/2" 94-pcs BMCS
	309901	1 Socket set 1/4", 3/8" & 1/2" 99-pcs BMCS
	3310115...22	5 Wheel socket 1/2", 15, 17, 19, 21, 22mm
	3358513...32	9 Deep impact socket 1/2", 6 pt. 13, 17, 19, 21, 22, 24, 27, 30, 32mm
	3397824...34	3 Deep impact socket 1/2", 12 pt. 24, 27, 34mm
	3398536	1 Deep impact socket 1/2", 12 pt. 36mm
	4110810...14	3 Flare nut wrench 8x10, 11x13, 12x14
	4120607...1617	6 Hinged socket wrench 6X7, 8X9, 10X11, 12X13, 14X15, 16X17mm
	41506...32	21 Combination wrench 6, 7, 8, 9, 10, 11, 12, 13, 14, 15, 16, 17, 18, 19, 20, 21, 22, 24, 27, 30, 32
	4170208...19	10 Reversible ratcheting wrench 12 pt. 8, 10, 11, 12, 13, 14, 15, 16, 17, 19mm
	42301250...2300	2 Adjustable wrench 10", 12"
	4311175	1 Combination pliers 7"
	4321200	1 Long nose pliers 8"
	4331200	1 Bent long nose pliers 8"
	4341175	1 Diagonal pliers 7"

TOOLS	ART. NO.	CONTENTS
	- 4342200	1 Leverage diagonal pliers 8"
	- 4351180	1 Waterpump pliers 7"
	- 4351250	1 Waterpump pliers 10"
	- 43611	1 Snap ring pliers (straight-open)
	- 43612	1 Snap ring pliers (straight-close)
	- 43613	1 Snap ring pliers (bent-open)
	- 43614	1 Snap ring pliers (bent-close)
	- 4380250	1 Locking pliers 10"
	- 4450250	1 Oil filter pliers 10"
	- 4450300	1 Oil filter pliers 12"
	- 4471250	1 Wire stripper 10"
	- 45118190	1 Grip chisel 190mm 18
	- 45124220	1 Grip chisel 220mm 24
	- 4533150	1 Grip pin punch 150mm 3"
	- 4534180	1 Grip pin punch 180mm 4"
	- 4536210	1 Grip pin punch 210mm 6"
	- 4611400	1 Machinist hammer with ash handle, 512gr
	- 4620400	1 Install hammer soft/hard, with ash handle, 608gr
	- 4631000	1 Stoning hammer with ash handle, 1106gr
	- 46601	1 Super heavy duty hacksaw
	- 46806	1 Utility knife (incl. 10 blades)
	- 46807	1 Utility knife (incl. 3 blades)
	- 46911	1 Flat file 8"
	- 46912	1 Half round file 8"
	- 46913	1 Round file 8"
	- 46914	1 Triangular file 8"
	- 47002	1 Feeler gauge 26-pcs
	- 47013	1 Measuring tape 5 meter
	- 47035	1 Multimeter AC/DC
	- 47022	1 Volt circuit tester 6-24V
	- 47023	1 Digital brake fluid tester
	- 47537	1 Flexible hex nut driver, 7mm
	- 47901	1 Door upholstery panel remover small 100mm
	- 47902	1 Door upholstery panel remover 110mm
	- 47903	1 Scraper
	- 47904	1 Cotter pin puller
	- 48023	1 Jack stands, 3 ton
	- 48025	1 Scissor jack 1 ton
	- 4820513	1 Inspections work light 8W
	- 4820514	1 Rechargeable COB work light 2W
	- 4820515	1 MAG work light
	- 4820516	1 Pocket-sized, ultra-slim work light
	- 4820517	1 Work lamp with top flash light
	- 4820518	1 Headlamp
	- 4821102	1 MAG LED work light and torch in one
	- 4821105	1 Flash pen
	- 48212380	1 Pry bar 380 mm
	- 600439	1 Mini hook set 4-pcs
	- 600507	1 Flexible flare nut wrench set, 5-pcs
	- 600618	1 Screwdriver set in colored box, 6-pcs
	- 600619	1 Screwdriver set TX in colored box, 6-pcs
	- 600620	1 Screwdriver set TX-H in colored box, 6-pcs

TOOLS	ART. NO.	CONTENTS
	600813	1 Foldable TX key set, 8-pcs
	600902	1 TX key set extra long, 9-pcs
	600912	1 Hex ball stubby key set, 9-pcs
	- 601001	1 16 in 1 ratchet screwdriver
	601006	1 Hex ball key set, long, 10-pcs
	601007	1 Hex key wrench set, extra long, 10-pcs
	601008	1 Hex ball key set extra long, 10-pcs
	- 601219	1 Reversible ratcheting wrench 12 pt. in pouch, 12-pcs
	- 601401	1 Combination wrench set in pouch, 14-pcs
	- 601702	1 Combination wrench set in pouch, 17-pcs
	multi 602006	1 Screwdriver set, 20-pcs
	- 7110101	1 Flexible ratchet 1/4", 45 teeth
	- 7110102	1 Flexible ratchet 3/8", 45 teeth
	- 7110202	1 Rotor ratchet 3/8", 72 teeth
	- 7110301	1 Disc ratchet 1/4", 72 teeth
	- 7110302	1 Disc ratchet 3/8", 72 teeth
	- 7120701	1 Ratchet 1/4", 72 teeth
	- 7120901	1 Ratchet 1/4", 45 teeth
	- 7120902	1 Ratchet 3/8", 45 teeth
	- 7120903	1 Ratchet 1/2", 45 teeth
	- 7133250	1 Sliding T-handle 1/2"
	- 7141050...1150	3 Extension 1/4", 50, 100, 150mm
	- 7142044...2250	4 Extension 3/8", 44, 75, 150, 250mm
	- 7143125...250	2 Extension 1/2", 125, 250mm
	- 71511	1 Universal joint 1/4"
	- 71521	1 Universal joint 3/8"
	- 71531	1 Universal joint 1/2"
	- 71632	1 Adaptor for extension 1/2 (F) x 3/8 (M)
	7172216...21	3 Spark plug clip socket 3/8", 16, 18, 21mm
	7174214	1 Spark plug socket 12 pt. 3/8", 14mm (90mm)
	7175214	1 Spark plug socket 12 pt. 3/8", 14mm (250mm)
	- 7233600	1 Swivel handle 1/2", 600mm
	- 7273380	1 Swivel grip handle 1/2", 370mm
	- 73220550	1 Torque wrench 3/8", 10-50Nm
	- 732320200	1 Torque wrench 1/2", 40-200Nm
	- 732360300	1 Torque wrench 1/2", 60-300Nm
	- 73531	1 Impact universal joint 1/2"
	- 801016	1 Brake caliper service set, pneumatic 16-pcs
	- 801018	1 Brake caliper service set 18-pcs
	- 802214	1 Drain plug key set 3/8", 14-pcs
	- 803005	1 Pry remover set 5-pcs
	- 805001	1 Glow plug socket set 3/8", 3-pcs
	- 806001	1 Alternator tools 13-pcs
	807001	1 Hub nut impact socket set 1/2", 12-pt. 3-pcs
	8113701...03	3 Bit socket PH 1/4", PH.1, PH.2, PH.3
	- 813001	1 Crimping plier set with exchangeable heads 7-pcs
	- 813003	1 Wire stripper 0.2-6.0mm
	8143703...10	6 Bit socket hex 1/4", 3, 4, 5, 6, 7, 10mm
	8163710...40	7 Bit socket TX 1/4", T10, T15, T20, T25, T27, T30, T40
	8173720...30	4 Bit socket TX tamperproof 1/4", T20H, T25H, T27H, T30H
	- 821001	1 Pry removal master kit 27-pcs
	8244804...12	9 Bit socket hex 3/8", 4, 5, 5.5, 6, 7, 8, 9, 10, 12mm

Sonic displays

TOOLS	ART. NO.	CONTENTS
	8264815...55	9 Bit socket TX 3/8", T15, T20, T25, T27, T30, T40, T45, T50, T55
	8274820...50	7 Bit socket TX tamperproof 3/8", T20H, T25H, T27H, T30H, T40H, T45H, T50H
	8284806...12	5 Bit socket spline 3/8", M6, M8, M9, M10, M12
	83406205...12	6 Bit socket hex 1/2", 5, 6, 7, 8, 10, 12mm
	83410006...08	3 Bit socket hex 1/2", 100mm l 6, 7, 8mm
	83606227...60	7 Bit socket TX 1/2", T27, T30, T40, T45, T50, T55, T60
	83610040...55	4 Bit socket TX 1/2", 100mm l T40, T45, T50, T55
	83706227...55	6 Bit socket tamperproof 1/2", TX T27H, T30H, T40H, T45H, T50H, T55H
	83710040	1 Bit socket tamperproof 1/2", TX 100mm l T40H
	83806206...16	6 Bit socket spline 1/2", M6, M8, M10, M12, M14, M16
	83810006...14	5 Bit socket spline 1/2", 100mm l M6, M8, M10, M12, M14
	86807818	1 Impact bit socket XZN 1/2", 78L M18

FOR A COMPLETE INVENTORY ORDER LIST SEE OUR WEBSITE

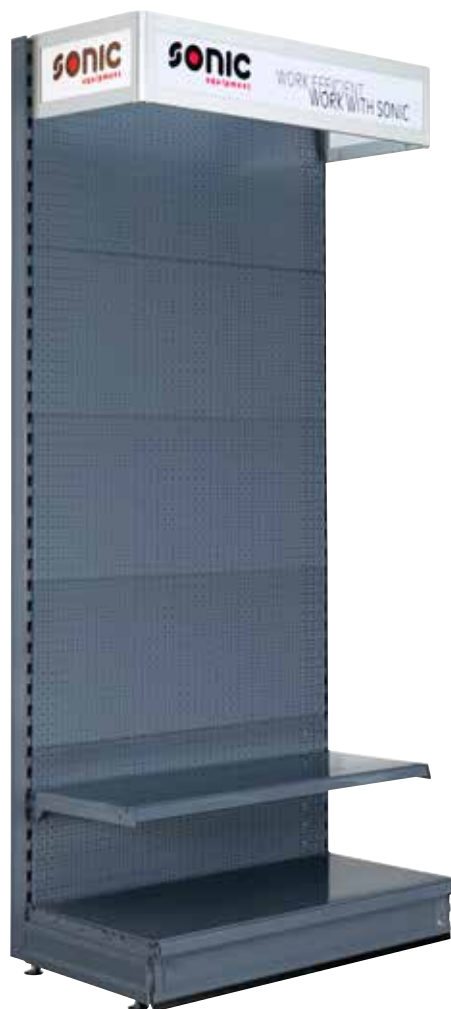

WALLDISPLAY EMPTY

ART. NO.	DESCRIPTION
47790	Display 1 meter
47791	Display 2 meter
47792	Display 3 meter
47796	Display 1 meter including hooks and lightbox
47797	Display 2 meter including hooks and lightbox
47798	Display 3 meter including hooks and lightbox
47534	Light box Sonic
47535	Single hook L10 Ø4mm
47795	Display follow meter





**WORK
EFFICIENT
WORK
WITH SONIC**

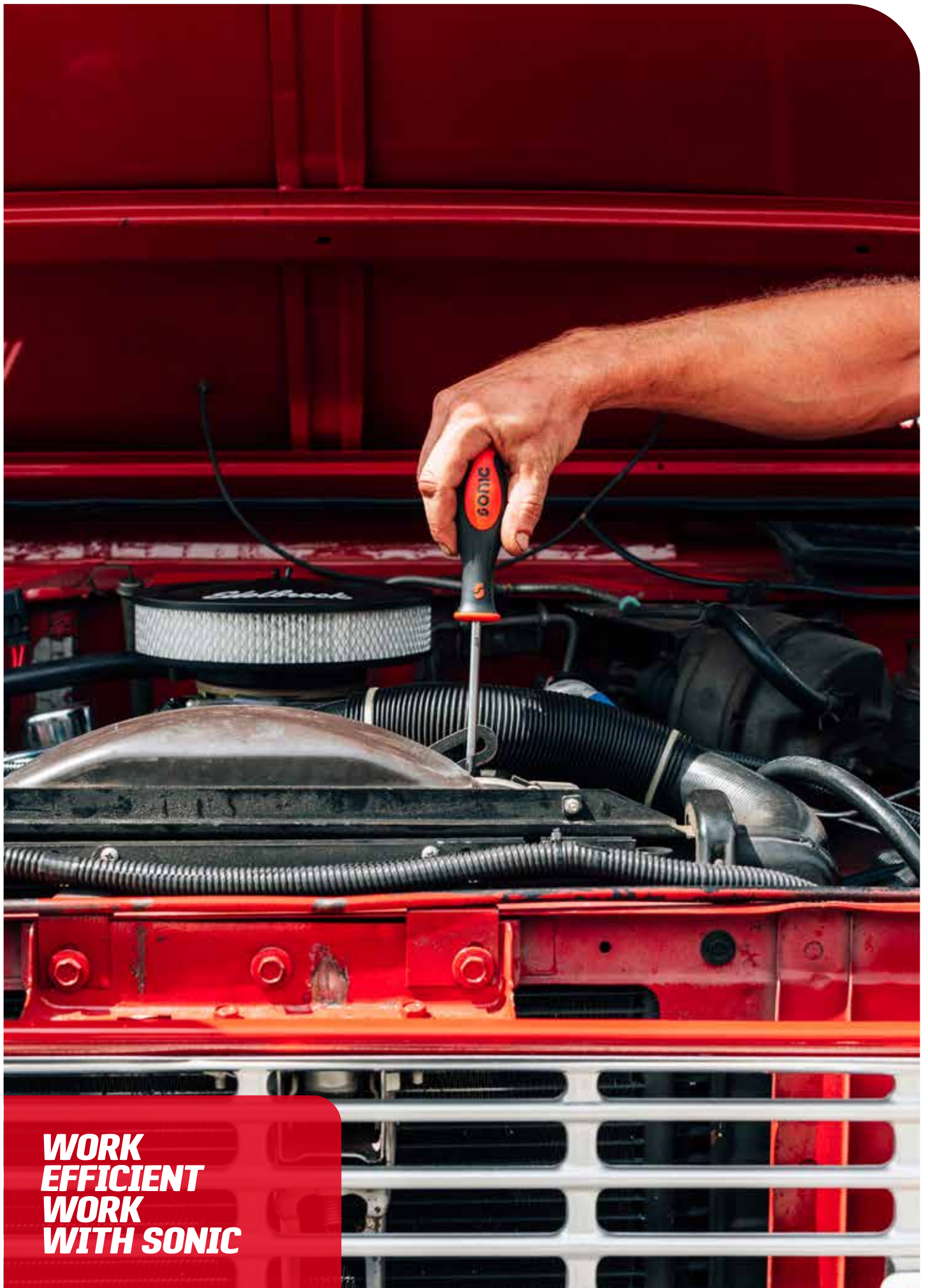

10

**WORK
EFFICIENT
WORK
WITH SONIC**



SONIC SCREW- DRIVERS

Sturdy construction & unique ergonomic grip.

10 > Sonic Screwdrivers

 > Screwdrivers, PH
PAGE 313

 > Flexible hex nut drivers
PAGE 315

 > Screwdrivers, PZ
PAGE 313

 > Hex nut drivers T-handle
PAGE 315

 > Screwdrivers, slotted
PAGE 313

 > Hex ball point grip key
PAGE 315

 > Screwdrivers, TX
PAGE 314

 > TX grip key
PAGE 315

 > Screwdrivers, TX tamperproof
PAGE 314

 > Hammer screwdrivers
PAGE 313

 > Hex nut drivers
PAGE 314

 > VDE screwdrivers
PAGE 313, 314

SCREWDRIVER, PH

DIN NO. ISO 8764-1 + 8764-2



ART. NO.	SIZE	L1(MM)	L(MM)	G	PCS/BAG
1310	PH.0	60	152	20	10
1311	PH.1	80	183	62	10
1312	PH.2	100	215	94	10
1313	PH.3	150	274	156	10

SCREWDRIVER, STUBBY PH

DIN NO. ISO 8764-1 + 8764-2



ART. NO.	SIZE	L1(MM)	L(MM)	G	PCS/BAG
1311S	PH.1	38	104	44	10
1312S	PH.2	38	104	48	10

HAMMER GO-THROUGH SCREWDRIVER, PH

DIN NO. ISO 8764-1 + 8764-2



ART. NO.	SIZE	L1(MM)	L(MM)	G	PCS/BAG
15101	PH.1	75	179	84	5
15102	PH.2	100	215	138	5

SCREWDRIVER EXTRA LONG

DIN NO. ISO 2380-1 + 2380-2



ART. NO.	SIZE	L1(MM)	L(MM)	G	PCS/BAG
1312502	PH.2	250	365	130	10
1314502	PH.2	450	565	218	5

VDE SCREWDRIVER, PH

DIN NO. ISO 8764 + EN 60900



ART. NO.	SIZE	L1(MM)	L(MM)	G	PCS/BAG
1610	PH.0	60	133	20	5
1611	PH.1	80	184	62	5
1612	PH.2	100	215	94	5

SCREWDRIVER, PZ

DIN NO. ISO 8764-1 + 8764-2



ART. NO.	SIZE	L1(MM)	L(MM)	G	PCS/BAG
1320	PZ.0	60	152	22	10
1321	PZ.1	80	183	64	10
1322	PZ.2	100	215	96	10
1323	PZ.3	150	274	158	5

SCREWDRIVER, STUBBY PZ

DIN NO. ISO 8764-1 + 8764-2



ART. NO.	SIZE	L1(MM)	L(MM)	G	PCS/BAG
1321S	PZ.1	38	104	42	10
1322S	PZ.2	38	104	48	10

SCREWDRIVER, SLOTTED

DIN NO. ISO 2380-1 + 2380-2



ART. NO.	SIZE	L1(MM)	L(MM)	G	PCS/BAG
13303	3	75	167	20	10
13335	3.5	100	192	24	10
13304	4	100	192	28	10
13355	5.5	125	228	72	10
13365	6.5	150	265	104	10
13308	8	175	299	164	10
13310	10	200	324	228	10
13312	12	200	324	238	10

SCREWDRIVER, STUBBY SLOTTED

DIN NO. ISO 2380-1 + 2380-2



ART. NO.	SIZE	L1(MM)	L(MM)	G	PCS/BAG
133055S	5.5	38	104	44	10
133065S	6.5	38	104	48	10

HAMMER GO-THROUGH SCREWDRIVER, SLOTTED

DIN NO. ISO 2380-1 + 2380-2



ART. NO.	SIZE	L1(MM)	L(MM)	G	PCS/BAG
1530155	5.5	100	204	88	5
1530165	6.5	125	240	144	5
1530108	8	150	275	208	5

SCREWDRIVER EXTRA LONG

DIN NO. ISO 2380-1 + 2380-2



ART. NO.	SIZE	L1(MM)	L(MM)	G	PCS/BAG
13325004	4	250	342	52	10
13325055	5.5	250	353	92	10
13325065	6.5	250	365	132	10
13345065	6.5	450	565	218	5
13360008	8	600	724	370	5

Sonic screwdrivers

VDE SCREWDRIVER, SLOTTED

DIN NO. ISO 2380 + EN 60900



ART. NO.	SIZE	L1[MM]	L[MM]	G	PCS/BAG
16325	2.5	75	148	20	5
16304	4	100	204	62	5
16355	5.5	125	229	78	5
16365	6.5	150	265	116	5

ELECTRONIC SCREWDRIVER



ART. NO.	SIZE	L1[MM]	L[MM]	G	PCS/BAG
17320002	2	100	192	20	10

ELECTRIC MAIN TESTER 120-250V

DIN NO. ISO 8764-1 + 8764-2



ART. NO.	L[MM]	G	PCS/BAG
47016	133	20	5

SCREWDRIVER, TX



ART. NO.	SIZE	L1[MM]	L[MM]	N.W. [G]	PCS/BAG
13605	T5	75	167	24	10
13606	T6	75	167	24	10
13607	T7	75	167	24	10
13608	T8	75	167	24	10
13609	T9	75	167	26	10
13610	T10	100	203	64	10
13615	T15	100	203	66	10
13620	T20	100	203	68	10
13625	T25	100	215	94	10
13627	T27	100	215	94	10
13630	T30	100	215	94	10
13640	T40	100	215	102	10
13645	T45	100	224	136	10

SCREWDRIVER LONG



ART. NO.	SIZE	L1[MM]	L[MM]	G	PCS/BAG
1342503	3	250	342	46	10
1342504	4	250	353	94	10
1342505	5	250	365	132	10
1342506	6	250	365	156	10

SCREWDRIVER, TX



ART. NO.	SIZE	L1[MM]	L[MM]	G	PCS/BAG
13625015	T15	250	353	94	10
13625020	T20	250	353	94	10
13625025	T25	250	365	132	10
13625027	T27	250	365	132	10
13625030	T30	250	365	132	10
13625040	T40	250	365	132	10
13625045	T45	250	365	184	10

SCREWDRIVER, TX TAMPERPROOF



ART. NO.	SIZE	L1[MM]	L[MM]	N.W. [G]	PCS/BAG
13708	T8H	75	167	24	10
13710	T10H	100	203	64	10
13715	T15H	100	203	66	10
13720	T20H	100	203	68	10
13725	T25H	100	215	94	10
13727	T27H	100	215	94	10
13730	T30H	100	215	94	10
13740	T40H	100	215	102	10

HEX NUT DRIVER



ART. NO.	SIZE	L1[MM]	L[MM]	G	PCS/BAG
12425004	4	125	240	115	10
12425005	5	125	240	119	10
124250055	5.5	125	240	121	10
12425006	6	125	240	123	10
12425008	8	125	240	131	10
12425009	9	125	240	131	10
12425010	10	125	240	135	10
12425011	11	125	249	167	10
12425012	12	125	249	171	10
12425013	13	125	249	173	10

PRECISION SCREWDRIVER, SLOTTED, PH



ART. NO.	SIZE	L[MM]	G	PCS/BAG
47837	2	155	14	10
47838	3	155	16	10
47839	PH.0 x 60	155	16	10
47840	PH.00 x 60	155	14	10

FLEXIBLE HEX NUT DRIVER



ART. NO.	SIZE	L1(MM)	L2(MM)	G	PCS/BAG
47536	6	150	274	151	10
47537	7	150	274	151	10
47538	8	150	274	151	10

FLEXIBLE SOCKET SCREWDRIVER



ART. NO.	SIZE	L(MM)	G	PCS/BAG
4753701	7	545	260	10

HEX NUT DRIVER T-HANDLE

DIN NO. ISO 3125



ART. NO.	SIZE	L1(MM)	L2(MM)	G	PCS/BAG
14423005	5	230	287	112	5
14423006	6	230	287	136	5
14423007	7	230	287	146	5
14423008	8	230	287	148	5
14423009	9	230	287	150	5
14423010	10	230	287	156	5
14423011	11	230	287	188	5
14423012	12	230	287	192	5
14423013	13	230	287	196	5

HEX BALL POINT GRIP KEY

DIN NR. ISO 2936



ART. NO.	SIZE	L1(MM)	L2(MM)	G	PCS/BAG
1950202	2	103	142	18	10
19502025	2.5	103	142	20	10
1950203	3	103	142	24	10
1950204	4	103	142	36	10
1950205	5	153	206	80	10
1950206	6	153	206	100	10
1950207	7	153	206	120	10
1950208	8	193	246	178	10
1950210	10	200	270	336	10
1950212	12	200	270	434	10

TX GRIP KEY



ART. NO.	SIZE	L1(MM)	L2(MM)	G	PCS/BAG
1960208	T8	103	142	26	10
1960210	T10	103	142	28	10
1960215	T15	103	142	28	10
1960220	T20	103	142	28	10
1960225	T25	153	206	80	10
1960227	T27	153	206	80	10
1960230	T30	153	206	80	10
1960240	T40	178	231	106	10
1960245	T45	200	270	188	10
1960250	T50	200	270	236	10

16 IN 1 RATCHET SCREWDRIVER



ART. NO.	CONTENTS	PCS
601001-1	Ratchet grip	1
601001-2	Bit holder	1
601001-3	Bit PH.1 + PH.2	1
601001-4	Bit PZ.1 + PZ.2	1
601001-5	Bit slotted 3.5mm + 5mm	1
601001-6	Bit 1/4" driver	1
601001-7	Bit T10 + T15	1
601001-8	Bit T20 + T25	1
601001-9	Bit T27 + T30	1
601001-10	Bit hex 3mm + 4mm	1
601001	16 in 1 ratchet screwdriver	1

SCREWDRIVER TRY ME



ART. NO.	L1(MM)	D1(MM)	D2(MM)	W1(MM)	G	PCS/BAG
47828	335	40,5	29	40,5	220	1

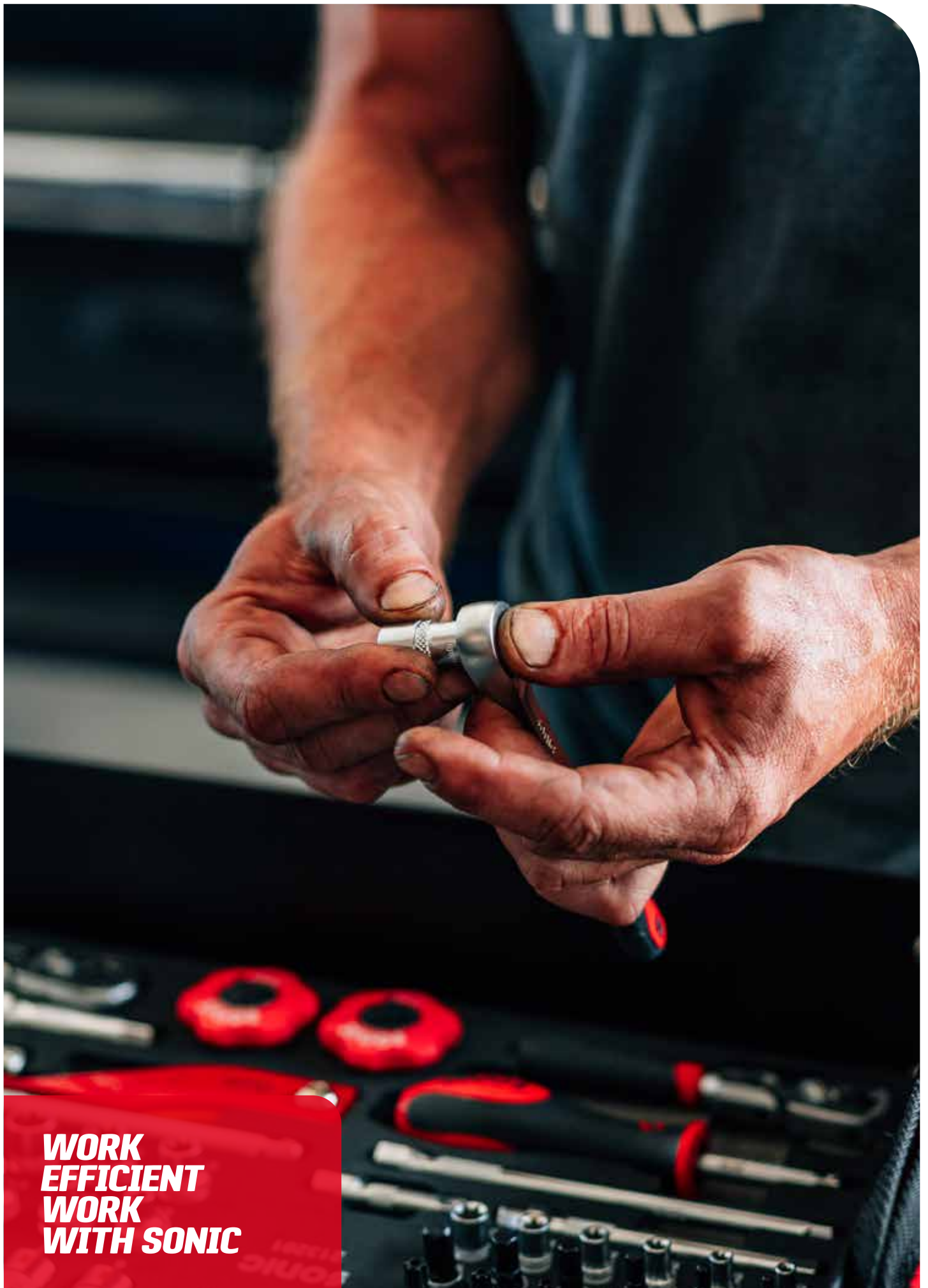

11

**WORK
EFFICIENT
WORK
WITH SONIC**



SONIC SOCKETS

Ensure optimal force while preventing damage.

11 > Sonic sockets

 > Sockets 1/4" 6 pt.
PAGE 319

 > Sockets 1/4" 12 pt.
PAGE 319

 > Sockets 1/4" SAE
PAGE 320

 > Sockets 1/4" TX
PAGE 320

 > Cardan sockets 1/4"
PAGE 320

 > Sockets 3/8" 6 pt.
PAGE 321

 > Sockets 3/8" 12 pt.
PAGE 322

 > Sockets 3/8" SAE
PAGE 322

 > Sockets 3/8" TX
PAGE 323

 > Cardan sockets 3/8"
PAGE 323

 > Glow plug sockets 3/8"
PAGE 324

 > Sockets 1/2" 6 pt.
PAGE 324

 > Sockets 1/2" 12 pt.
PAGE 325

 > Sockets 1/2" SAE
PAGE 326

 > Sockets 1/2" TX
PAGE 327

 > Cardan sockets 1/2"
PAGE 327

 > Sockets 3/4" 12 pt.
PAGE 327

 > Sockets 3/4" SAE
PAGE 328

 > Sockets 1" 12 pt.
PAGE 328

 > Wheel sockets 1/2" 6 pt.
PAGE 328

 > Impact sockets 3/8" 6 pt.
PAGE 329

 > Brake caliper socket 1/2"
PAGE 330

 > Impact sockets 1/2" 6 pt.
PAGE 330

 > Impact sockets 1/2" 12 pt.
PAGE 331

 > Impact cardan sockets 1/2" 6 pt.
PAGE 331

 > Impact socket 1/2", TX
PAGE 332

 > Impact sockets 3/4" 6 pt.
PAGE 332

 > Impact sockets 3/4" 12 pt.
PAGE 333

 > Impact sockets 3/4" TX
PAGE 333

 > Impact sockets 1" 6 pt.
PAGE 334

 > Spark plug sockets 3/8"
PAGE 335

 > Spark plug sockets 1/2"
PAGE 335

FLANK SOCKET 1/4", 6 PT

DIN NO. 3120/3124

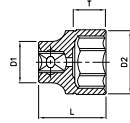
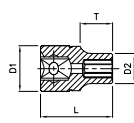

6.3
1/4"

ART. NO.	SIZE	L(MM)	D2(MM)	G	PCS/BAG
21503	3	25	6	10	10
21504	4	25	6,8	10	10
21545	4,5	25	7,2	10	10
21505	5	25	7,8	10	10
21555	5,5	25	8,4	10	10
21506	6	25	9,3	10	10
21507	7	25	11	12	10
21508	8	25	12	10	10
21509	9	25	13	12	10
21510	10	25	15	12	10
21511	11	25	16	16	10
21512	12	25	17	18	10
21513	13	25	18	18	10
21514	14	25	19	26	10

SOCKET 1/4", 12 PT.

DIN NO. 3120

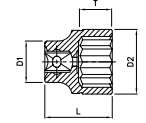
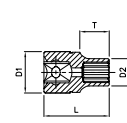

6.3
1/4"

ART. NO.	SIZE	L(MM)	D2(MM)	G	PCS/BAG
21804	4	25	6,8	10	10
21845	4,5	25	7,2	10	10
21805	5	25	7,8	10	10
21855	5,5	25	8,4	10	10
21806	6	25	9,3	10	10
21807	7	25	11	12	10
21808	8	25	12	10	10
21809	9	25	13	12	10
21810	10	25	15	12	10
21811	11	25	16	16	10
21812	12	25	17	18	10
21813	13	25	18	18	10

FLANK DEEP SOCKET 1/4", 6 PT.

DIN NO. 3120/3124

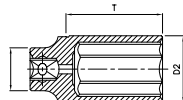
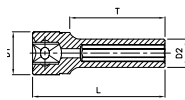

6.3
1/4"

ART. NO.	SIZE	L(MM)	D2(MM)	G	PCS/BAG
2155004	4	50	6,8	16	10
21550045	4,5	50	7,2	16	10
2155005	5	50	7,8	16	10
21550055	5,5	50	8,4	14	10
2155006	6	50	9,3	18	10
2155007	7	50	11	22	10
2155008	8	50	12	22	10
2155009	9	50	13	28	10
2155010	10	50	15	32	10
2155011	11	50	16	38	10
2155012	12	50	17	42	10
2155013	13	50	18	46	10

DEEP SOCKET 1/4", 12 PT.

DIN NO. 3120

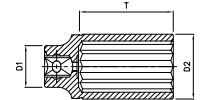
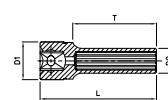

6.3
1/4"

ART. NO.	SIZE	L(MM)	D2(MM)	G	PCS/BAG
2185004	4	50	6,8	16	10
21850045	4,5	50	7,2	16	10
2185005	5	50	7,8	16	10
21850055	5,5	50	8,4	14	10
2185006	6	50	9,3	18	10
2185007	7	50	11	22	10
2185008	8	50	12	22	10
2185009	9	50	13	28	10
2185010	10	50	15	32	10
2185011	11	50	16	38	10
2185012	12	50	17	42	10
2185013	13	50	18	46	10

Sonic sockets

SOCKET 1/4", 12 PT. SAE

DIN NO. 3120

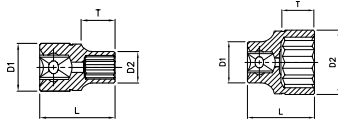

6.3



ART. NO.	SIZE	L(MM)	D2(MM)	G	PCS/BAG
21905	3/16"	25	7,8	10	10
21955	7/32"	25	8,4	10	10
21906	1/4"	25	9,3	10	10
21907	9/32"	25	11	10	10
21908	5/16"	25	12	10	10
21909	11/32"	25	13	10	10
21910	3/8"	25	14	10	10
21911	7/16"	25	16	15	10
21913	1/2"	25	18	20	10
21914	9/16"	25	20	26	10

DEEP SOCKET 1/4", 12 PT. SAE

DIN NO. 3120



6.3



ART. NO.	SIZE	L(MM)	D2(MM)	G	PCS/BAG
2195005	3/16"	50	7,2	15	10
21950055	7/32"	50	8,4	15	10
2195006	1/4"	50	9,3	20	10
2195007	9/32"	50	11	20	10
2195008	5/16"	50	12	20	10
2195009	11/32"	50	13	25	10
2195010	3/8"	50	14	30	10
2195011	7/16"	50	16	35	10
2195012	1/2"	50	18	45	10
2195014	9/16"	50	20	48	10

SOCKET 1/4", TX

DIN NO. 3120



6.3

ART. NO.	SIZE	L(MM)	D2(MM)	G	PCS/BAG
21604	E4	25	6	10	10
21605	E5	25	7	10	10
21606	E6	25	8	10	10
21607	E7	25	9	10	10
21608	E8	25	10	10	10
21610	E10	25	11,5	12	10

DEEP SOCKET 1/4", TX

DIN NO. 3120



6.3

ART. NO.	SIZE	L(MM)	D2(MM)	G	PCS/BAG
2165004	E4	50	6	14	10
2165005	E5	50	7	16	10
2165006	E6	50	8	18	10
2165007	E7	50	9	18	10
2165008	E8	50	10	20	10
2165010	E10	50	11,5	26	10

CARDAN SOCKET 1/4", 12 PT.

DIN NO. 3120



6.3

ART. NO.	SIZE	L(MM)	D2(MM)	G	PCS/BAG
7151806	6	35	9,2	22	10
7151807	7	35	10,5	22	10
7151808	8	36,5	11,7	22	10
7151809	9	36,5	13	22	10
7151810	10	38,5	13,8	24	10
7151811	11	39,5	15,6	26	10
7151812	12	40	16,7	26	10
7151813	13	40	18	28	10

CARDAN SOCKET 1/4", TX

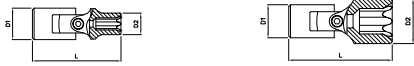

6.3
1/4"

ART. NO.	SIZE	L(MM)	D2(MM)	G	PCS/BAG
7151604	E4	40	6	24	10
7151605	E5	40	6,8	24	10
7151606	E6	40	7,8	26	10
7151607	E7	40	8,8	26	10
7151608	E8	40	9,8	26	10

DEEP FLANK SOCKET 3/8", 6 PT.

DIN NO. 3120/3124



10
3/8"

ART. NO.	SIZE	L(MM)	D2(MM)	G	PCS/BAG
2256306	6	63	9,3	34	10
2256307	7	63	10,6	36	10
2256308	8	63	11,8	34	10
2256309	9	63	13,2	44	10
2256310	10	63	14,5	46	10
2256311	11	63	15,7	50	10
2256312	12	63	18	62	10
2256313	13	63	19	68	10
2256314	14	63	20	74	10
2256315	15	63	22	96	10
2256316	16	63	22	82	10
2256317	17	63	24	106	10
2256318	18	63	26	130	10
2256319	19	63	26	116	10
2256320	20	63	28	148	10
2256321	21	63	28	126	10
2256322	22	63	30	160	10

FLANK SOCKET 3/8", 6 PT.

DIN NO. 3120/3124

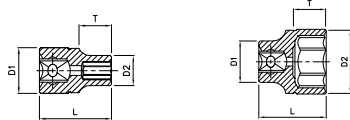

10
3/8"

ART. NO.	SIZE	L(MM)	D2(MM)	G	PCS/BAG
22506	6	28	9,3	20	10
22507	7	28	10,6	22	10
22508	8	28	11,8	22	10
22509	9	28	13,2	22	10
22510	10	28	14,5	22	10
22511	11	28	15,7	24	10
22512	12	28	17	22	10
22513	13	28	18	24	10
22514	14	28	20	28	10
22515	15	28	22	34	10
22516	16	28	22	32	10
22517	17	30	24	40	10
22518	18	30	26	42	10
22519	19	30	26	46	10
22520	20	30	28	60	10
22521	21	30	28	50	10
22522	22	32	30	60	10
22524	24	32	32	62	10

Sonic sockets

SOCKET 3/8", 12 PT.

DIN NO. 3120



10
3/8"

ART. NO.	SIZE	L(MM)	D2(MM)	G	PCS/BAG
22806	6	28	9,3	20	10
22807	7	28	10,6	22	10
22808	8	28	11,8	22	10
22809	9	28	13,2	22	10
22810	10	28	14,5	22	10
22811	11	28	15,7	24	10
22812	12	28	17	22	10
22813	13	28	18	24	10
22814	14	28	20	28	10
22815	15	28	22	34	10
22816	16	28	22	32	10
22817	17	30	24	40	10
22818	18	30	26	42	10
22819	19	30	26	46	10
22820	20	30	28	60	10
22821	21	30	28	50	10
22822	22	32	30	60	10
22824	24	32	32	62	10

FLANK DEEP SOCKET 3/8", 12 PT.

DIN NO. 3120



10
3/8"

ART. NO.	SIZE	L(MM)	D2(MM)	G	PCS/BAG
2286306	6	63	9,3	34	10
2286307	7	63	10,6	36	10
2286308	8	63	11,8	34	10
2286309	9	63	13,2	44	10
2286310	10	63	14,5	46	10
2286311	11	63	15,7	50	10
2286312	12	63	18	62	10
2286313	13	63	19	68	10
2286314	14	63	20	74	10
2286315	15	63	22	96	10
2286316	16	63	22	82	10
2286317	17	63	24	106	10
2286318	18	63	26	130	10
2286319	19	63	26	116	10
2286320	20	63	28	148	10
2286321	21	63	28	126	10
2286322	22	63	30	160	10
2286324	24	63	32	210	10

SOCKET 3/8", 12 PT. SAE

DIN NO. 3120



10
3/8"



ART. NO.	SIZE	L(MM)	D2(MM)	G	PCS/BAG
22906	1/4"	28	9,3	20	10
22908	5/16"	28	11,8	20	10
22910	3/8"	28	14,5	20	10
22911	7/16"	28	15,7	20	10
22913	1/2"	28	18	25	10
22914	9/16"	28	20	25	10
22916	5/8"	28	22	30	10
22917	11/16"	30	24	35	10
22919	3/4"	30	26	45	10
22921	13/16"	30	28	50	10
22922	7/8"	30	30	60	10

DEEP SOCKET 3/8", 12 PT. SAE

DIN NO. 3120



ART. NO.	SIZE	L(MM)	D2(MM)	G	PCS/BAG
2296306	1/4"	63	11,4	42	10
2296308	5/16"	63	12,4	44	10
2296310	3/8"	63	14,5	45	10
2296311	7/16"	63	15,7	50	10
2296313	1/2"	63	18	65	10
2296314	9/16"	63	20	70	10
2296316	5/8"	63	22	85	10
2296317	11/16"	63	24	100	10
2296319	3/4"	63	26	115	10
2296321	13/16"	63	28	130	10
2296322	7/8"	63	30	150	10

DEEP SOCKET 3/8", TX

DIN NO. 3120



ART. NO.	SIZE	L(MM)	D2(MM)	G	PCS/BAG
2266304	E4	63	6	26	10
2266305	E5	63	7	28	10
2266306	E6	63	8	34	10
2266307	E7	63	9	32	10
2266308	E8	63	10	38	10
2266310	E10	63	12	42	10
2266311	E11	63	13	42	10
2266312	E12	63	14	50	10
2266314	E14	63	16	64	10
2266316	E16	63	18	68	10
2266318	E18	63	20	129	10
2266320	E20	63	24	151	10

SOCKET 3/8", TX

DIN NO. 3120

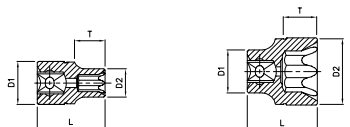

ART. NO.	SIZE	L(MM)	D2(MM)	G	PCS/BAG
22604	E4	28	6	20	10
22605	E5	28	7	22	10
22606	E6	28	8	20	10
22607	E7	28	9	22	10
22608	E8	28	10	22	10
22610	E10	28	12	22	10
22611	E11	28	13	24	10
22612	E12	28	14	24	10
22614	E14	28	16	24	10
22616	E16	28	18	28	10
22618	E18	28	20	58	10
22620	E20	30	22	72	10

CARDAN SOCKET 3/8"

DIN NO. 3120



ART. NO.	SIZE	L(MM)	D2(MM)	G	PCS/BAG
7152810	10	49,5	14,5	60	10
7152811	11	50,5	15,8	60	10
7152812	12	51	17	60	10
7152813	13	52	18,3	60	10
7152814	14	52	20	60	10
7152815	15	54,5	22	65	10
7152816	16	54,5	22	65	10
7152817	17	55,5	24	70	10
7152818	18	55,5	26	70	10
7152819	19	57,5	26	75	10

Sonic sockets

CARDAN SOCKET 3/8", TX



10
3/8"

ART. NO.	SIZE	L(MM)	D2(MM)	G	PCS/BAG
7152610	E10	60	13,8	66	10
7152612	E12	61	14,6	68	10
7152614	E14	61	16,7	72	10
7152616	E16	61	18,5	76	10

GLOW PLUG SOCKET 3/8"



10
3/8"

ART. NO.	SIZE	L(MM)	D2(MM)	G	PCS/BAG
7176208	8	72	12	64	10
7176209	9	72	13	70	10
7176210	10	72	14	72	10
7176212	12	72	16	72	10
7176214	14	80	18	82	10
7176216	16	80	20	94	10

FLANK SOCKET 1/2", 6 PT.

DIN NO. 3120/3124

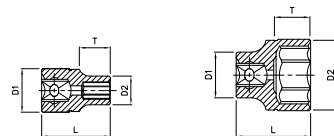

12.5
1/2"

ART. NO.	SIZE	L(MM)	D2(MM)	G	PCS/BAG
23508	8	38	12,2	46	10
23509	9	38	13,5	48	10
23510	10	38	15	48	10
23511	11	38	16,3	50	10
23512	12	38	17,6	50	10
23513	13	38	18,8	52	10
23514	14	38	20,4	54	10
23515	15	38	21	52	10
23516	16	38	22	48	10
23517	17	38	24	60	10
23518	18	38	26	70	10
23519	19	38	26	58	10
23520	20	38	28	70	10
23521	21	38	28	60	10
23522	22	38	30	88	10
23523	23	38	32	98	10
23524	24	38	32	90	10
23525	25	42	34	118	10
23526	26	42	36	142	10
23527	27	42	36	136	10
23528	28	43	38	154	10
23529	29	43	38	134	10
23530	30	43	40	158	10
23532	32	43	42	168	10

FLANK DEEP SOCKET 1/2", 6 PT.

DIN NO. 3120/3124



**12.5
1/2"**

ART. NO.	SIZE	L(MM)	D2(MM)	G	PCS/BAG
2357708	8	77	12,2	70	10
2357709	9	77	13,5	74	10
2357710	10	77	15	66	10
2357711	11	77	16,3	78	10
2357712	12	77	17,6	82	10
2357713	13	77	18,8	96	10
2357714	14	77	20,4	104	10
2357715	15	77	21	98	10
2357716	16	77	22	100	10
2357717	17	77	24	130	10
2357718	18	77	26	154	10
2357719	19	77	26	142	10
2357720	20	77	28	168	10
2357721	21	77	28	152	10
2357722	22	77	30	204	10
2357723	23	77	32	228	10
2357724	24	77	32	218	10
2357725	25	77	34	254	10
2357726	26	77	36	300	10
2357727	27	77	36	286	10
2357728	28	77	38	320	10
2357729	29	77	38	300	10
2357730	30	77	40	346	10
2357732	32	77	42	364	10

SOCKET 1/2", 12 PT.

DIN NO. 3120

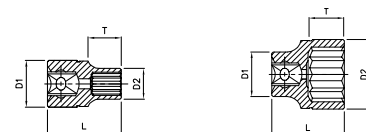

**12.5
1/2"**

ART. NO.	SIZE	L(MM)	D2(MM)	G	PCS/BAG
23808	8	38	12,2	46	10
23809	9	38	13,5	48	10
23810	10	38	15	48	10
23811	11	38	16,3	50	10
23812	12	38	17,6	50	10
23813	13	38	18,8	52	10
23814	14	38	20,4	54	10
23815	15	38	21	52	10
23816	16	38	22	48	10
23817	17	38	24	60	10
23818	18	38	26	70	10
23819	19	38	26	58	10
23820	20	38	28	70	10
23821	21	38	28	60	10
23822	22	38	30	88	10
23823	23	38	32	98	10
23824	24	38	32	90	10
23825	25	42	34	118	10
23826	26	42	36	142	10
23827	27	42	36	136	10
23828	28	43	38	154	10
23829	29	43	38	134	10
23830	30	43	40	158	10
23832	32	43	42	168	10

Sonic sockets

DEEP SOCKET 1/2", 12 PT.

DIN NO. 3120

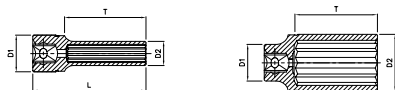

12.5
1/2"

ART. NO.	SIZE	L(MM)	D2(MM)	G	PCS/BAG
2387708	8	77	12,2	70	10
2387709	9	77	13,5	74	10
2387710	10	77	15	66	10
2387711	11	77	16,3	78	10
2387712	12	77	17,6	82	10
2387713	13	77	18,8	96	10
2387714	14	77	20,4	104	10
2387715	15	77	21	98	10
2387716	16	77	22	100	10
2387717	17	77	24	130	10
2387718	18	77	26	154	10
2387719	19	77	26	142	10
2387720	20	77	28	168	10
2387721	21	77	28	152	10
2387722	22	77	30	204	10
2387723	23	77	32	228	10
2387724	24	77	32	218	10
2387725	25	77	34	254	10
2387726	26	77	36	300	10
2387727	27	77	36	286	10
2387728	28	77	38	320	10
2387729	29	77	38	300	10
2387730	30	77	40	346	10
2387732	32	77	42	364	10

SOCKET 1/2", 12 PT. SAE

DIN NO. 3120

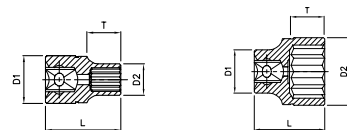

12.5
1/2"



ART. NO.	SIZE	L(MM)	D2(MM)	G	PCS/BAG
23910	3/8"	38	15	50	10
23911	7/16"	38	16,3	45	10
23913	1/2"	38	18,8	50	10
23914	9/16"	38	20,4	50	10
23916	5/8"	38	22	50	10
23917	11/16"	38	24	55	10
23919	3/4"	38	26	50	10
23921	13/16"	38	28	60	10
23922	7/8"	38	30	80	10
23924	15/16"	38	32	90	10
23925	1"	42	34	110	10
23927	1.1/16"	42	36	120	10
23929	1.1/8"	43	38	135	10
23930	1.3/16"	43	40	150	10
23932	1.1/4"	43	42	155	10

DEEP SOCKET 1/2", 12 PT. SAE

DIN NO. 3120

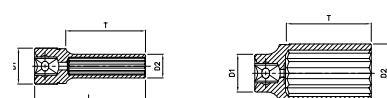

12.5
1/2"



ART. NO.	SIZE	L(MM)	D2(MM)	G	PCS/BAG
2397710	3/8"	77	15	65	10
2397711	7/16"	77	16,3	75	10
2397713	1/2"	77	18,8	90	10
2397714	9/16"	77	20,4	105	10
2397716	5/8"	77	22	95	10
2397717	11/16"	77	24	120	10
2397719	3/4"	77	26	135	10
2397721	13/16"	77	28	155	10
2397722	7/8"	77	30	190	10
2397724	15/16"	77	32	205	10
2397725	1"	77	34	235	10
2397727	1.1/16"	77	36	270	10
2397729	1.1/8"	77	38	300	10
2397730	1.3/16"	77	40	330	10
2397732	1.1/4"	77	42	355	10

SOCKET 1/2", TX

DIN NO. 3120

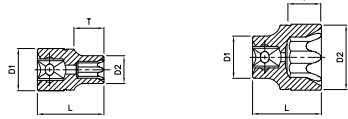

12.5
1/2"

ART. NO.	SIZE	L(MM)	D2(MM)	G	PCS/BAG
23610	E10	38	13	48	10
23611	E11	38	14	50	10
23612	E12	38	15	50	10
23614	E14	38	16	50	10
23616	E16	38	19	56	10
23618	E18	38	20	54	10
23620	E20	38	24	58	10
23622	E22	38	26	78	10
23624	E24	38	28	90	10

DEEP SOCKET 1/2", TX

DIN NO. 3120



12.5
1/2"

ART. NO.	SIZE	L(MM)	D2(MM)	G	PCS/BAG
2367710	E10	77	13	78	10
2367711	E11	77	14	82	10
2367712	E12	77	15	68	10
2367714	E14	77	16	74	10
2367716	E16	77	19	104	10
2367718	E18	77	20	110	10
2367720	E20	77	24	156	10
2367722	E22	77	26	192	10
2367724	E24	77	28	208	10

CARDAN SOCKET 1/2", TX

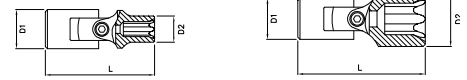

12.5
1/2"

ART. NO.	SIZE	L(MM)	D2(MM)	G	PCS/BAG
7153618	E18	69	21,5	138	10
7153620	E20	69	21,5	132	10
7153622	E22	69	26	148	10
7153624	E24	69	28	154	10

SOCKET 3/4", 12 PT.

DIN NO. 3120

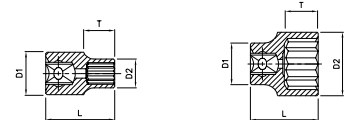

20
3/4"

ART. NO.	SIZE	L(MM)	D2(MM)	G	PCS/BAG
24917	17	50	27,2	140	2
24918	18	50	28,2	150	2
24919	19	50	29,2	164	2
24920	20	50	30,2	170	2
24921	21	50	31,2	166	2
24922	22	50	32,2	208	2
24923	23	50	33,2	208	2
24924	24	51	34,2	214	2
24925	25	52	36	220	2
24926	26	52	37	214	2
24927	27	52	38	214	2
24928	28	52	39,5	240	2
24929	29	52	40,5	232	2
24930	30	54	42	274	2
24932	32	56	44	286	2
24933	33	56	46	320	2
24934	34	56	47	340	2
24935	35	58	48	376	2
24936	36	58	50	400	2
24938	38	60	52	464	2
24941	41	64	56	526	2
24942	42	64	57	560	2
24946	46	66	62	632	2
24950	50	70	68	760	2
24955	55	76	74	900	2
24960	60	78	80	1050	2

Sonic sockets

SOCKET 3/4", 12 PT. SAE

DIN NO. 3120

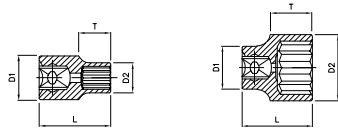

ART. NO.	SIZE	L(MM)	D2(MM)	G	PCS/BAG
24819	3/4"	50	29,2	164	2
24822	7/8"	50	32,2	212	2
24824	5/16"	51	34,2	218	2
24825	1"	52	37	220	2
24827	1.1/16"	52	38	220	2
24829	1.1/8"	52	40	240	2
24830	1.3/16"	54	42	266	2
24832	1.1/4"	56	44	286	2
24833	1.5/16"	56	46	310	2
24835	1.3/8"	58	48	368	2
24836	1.7/16"	58	50	398	2
24838	1.1/2"	60	52	454	2
24841	1.5/8"	64	56	530	2
24842	1.11/16"	65	58	560	2
24844	1.3/4"	66	60	604	2
24846	1.13/16"	68	62	632	2
24847	1.7/8"	70	64	700	2
24850	2"	72	68	760	2

SOCKET 1", 12 PT.

DIN NO. 3120

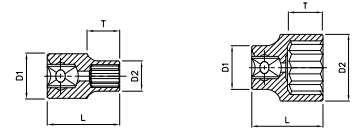

ART. NO.	SIZE	L(MM)	D2(MM)	G	PCS/BAG
25835	35	61	50	430	2
25836	36	65	52	454	2
25838	38	65	54	485	2
25841	41	70	57	580	2
25846	46	75	65	806	2
25850	50	75	70	956	2
25854	54	80	74	1150	2
25855	55	80	76	1190	2
25858	58	80	79	1285	2
25860	60	84	82	1248	2
25863	63	87	86	1500	1
25865	65	87	88	1450	1
25867	67	90	90	1640	1
25870	70	93	94	1946	1
25871	71	93	95	2100	1
25875	75	97	100	2294	1
25877	77	103	102	2500	1
25880	80	103	105	2328	1

WHEEL SOCKET 1/2"

DIN NO. 3121

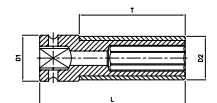

ART. NO.	SIZE	L(MM)	D2(MM)	G	PCS/BAG
3310115	15	85	25	202	5
3310117	17	86	26,4	196	5
3310119	19	86	28,4	224	5
3310121	21	86	30,4	252	5
3310122	22	85	33	284	5

WHEEL SOCKET 1/2"



12.5
1/2"

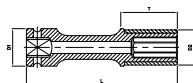

ART. NO.	SIZE	L(MM)	D2(MM)	G	PCS/BAG
3310517	17	150	27	215	5
3310519	19	150	29	265	5
3310521	21	150	31	290	5

WHEEL SOCKET 1/2"



12.5
1/2"

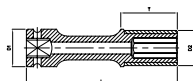

ART. NO.	SIZE	L(MM)	D2(MM)	G	PCS/BAG
3310817	17	151	27	374	5
3310819	19	151	28	386	5
3310821	21	151	30	406	5

WHEEL SOCKET 1/2"



12.5
1/2"

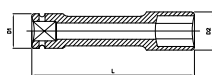

ART. NO.	SIZE	L(MM)	D2(MM)	G	PCS/BAG
3310217	17	105	24	222	5
3310219	19	105	26	194	5
3310221	21	105	27	200	5

TORQUE IMPACT SOCKET 1/2"



12.5
1/2"

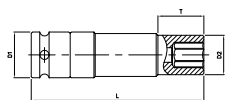

ART. NO.	SIZE	L(MM)	D2(MM)	G	PCS/BAG
3310317	17	100	26	362	5
3310319	19	100	29	392	5
3310321	21	100	30	398	5
3310322	22	100	32	422	5

NSI WHEEL SOCKET 1/2"



12.5
1/2"

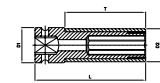

ART. NO.	SIZE	L(MM)	D2(MM)	G	PCS/BAG
3310715	15	88	26,6	96	5
3310717	17	87	26	184	5
3310719	19	87	28	184	5
3310721	21	87	28	216	5
3310722	22	87	31	244	5

IMPACT SOCKET 3/8", 6 PT.

DIN NO. 3121/3129



10
3/8"

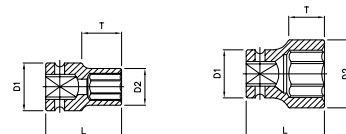

ART. NO.	SIZE	L(MM)	D2(MM)	G	PCS/BAG
32508	8	30	13,5	36	10
32509	9	30	15,2	42	10
32510	10	30	16,5	36	10
32511	11	30	17,6	34	10
32512	12	30	18,2	34	10
32513	13	30	20,2	52	10
32514	14	30	21,5	52	10
32515	15	30	22	48	10
32516	16	30	24	56	10
32517	17	30	25,2	60	10
32518	18	30	26,5	90	10
32519	19	30	27,7	66	10
32520	20	30	28,5	95	10
32521	21	30	30	100	10
32522	22	30	32	105	10

Sonic sockets

DEEP IMPACT SOCKET 3/8", 6 PT.

DIN NO. 3121/3129

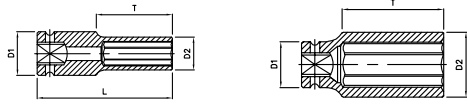

10
3/8"

ART. NO.	SIZE	L(MM)	D2(MM)	G	PCS/BAG
3256308	8	63	13,5	96	10
3256309	9	63	15,2	100	10
3256310	10	63	16,5	92	10
3256311	11	63	17,6	86	10
3256312	12	63	18,2	86	10
3256313	13	63	20,2	116	10
3256314	14	63	21,5	114	10
3256315	15	63	22,6	130	10
3256316	16	63	24	122	10
3256317	17	63	25,2	146	10
3256318	18	63	26,5	190	10
3256319	19	63	27,7	156	10
3256320	20	63	28,5	210	10
3256321	21	63	30	220	10
3256322	22	63	32	240	10

BRAKE CALIPER SOCKET, 1/2" 10 PT.

DIN NO. 3121

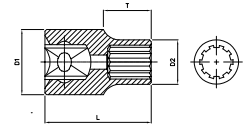

12.5
1/2"

ART. NO	SIZE	L(MM)	D2(MM)	G	PCS/BAG
805019	10	38	16	42	10

IMPACT SOCKET 1/2", 6 PT.

DIN NO. 3121/3129

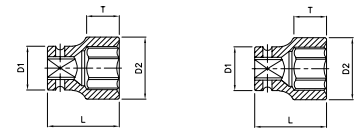

12.5
1/2"

ART. NO.	SIZE	L(MM)	D2(MM)	G	PCS/BAG
33508	8	38	15	60	5
33509	9	38	16	60	5
33510	10	38	16	60	5
33511	11	38	17,2	62	5
33512	12	38	19	64	5
33513	13	38	20,5	68	5
33514	14	38	23	80	5
33515	15	38	24	76	5
33516	16	38	24	72	5
33517	17	38	25,8	90	5
33518	18	38	28	108	5
33519	19	38	28	102	5
33520	20	38	29,8	120	5
33521	21	38	29,8	114	5
33522	22	38	31,8	132	5
33523	23	38	32,2	118	5
33524	24	38	33,8	126	5
33525	25	38	35,8	142	5
33526	26	38	35,8	134	5
33527	27	39	37,8	156	5
33528	28	40	40	164	5
33529	29	40	40	162	5
33530	30	40	41,8	184	5
33532	32	40	43,5	188	5
33533	33	44	46	310	5
33534	34	44	46	320	5
33535	35	48	48	330	5
33536	36	48	49	330	5
33538	38	48	52	480	5

WHEEL SOCKET 1/2", 17MM FOR MERCEDES-BENZ

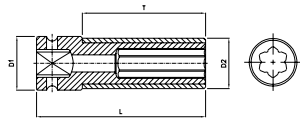

12.5
1/2"

ART. NO.	SIZE	L(MM)	D2(MM)	G	PCS/BAG
3310617	17	88	25	96	5

DEEP IMPACT SOCKET 1/2", 6 PT.

DIN NO. 3121/3129

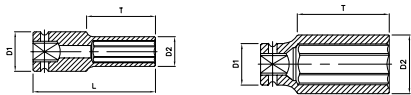

12.5
1/2"

ART. NO.	SIZE	L(MM)	D2(MM)	G	PCS/BAG
3358508	8	78	15	125	5
3358509	9	78	16	125	5
3358510	10	78	17,5	138	5
3358511	11	78	17,5	152	5
3358512	12	78	19,8	160	5
3358513	13	78	20,8	148	5
3358514	14	78	22,2	158	5
3358515	15	78	23,8	168	5
3358516	16	78	23,8	160	5
3358517	17	78	25,2	176	5
3358518	18	78	27,8	214	5
3358519	19	78	27,8	210	5
3358520	20	78	30	266	5
3358521	21	78	29,5	238	5
3358522	22	78	31,8	266	5
3358523	23	78	33,8	312	5
3358524	24	78	33,8	384	5
3358525	25	78	36	338	5
3358526	26	78	38	364	5
3358527	27	78	37,8	346	5
3358528	28	78	40	414	5
3358529	29	78	40	400	5
3358530	30	78	42	422	5
3358532	32	78	43,8	436	5
3358533	33	78	46	440	5
3358534	34	78	46	480	5
3358535	35	78	48	520	5
3358536	36	78	49	500	5
3358538	38	78	52	600	5

DEEP IMPACT SOCKET 1/2", 12 PT.

DIN NR. 3121

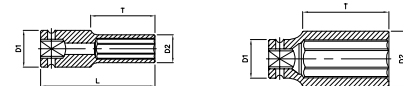

12.5
1/2"

ART. NO.	SIZE	L(MM)	D2(MM)	G	PCS/BAG
3397824	24	78	34	260	5
3397827	27	78	38	300	5
3397834	34	78	46	480	5
3397835	35	78	48	520	5

DEEP IMPACT SOCKET 1/2", 12 PT.

DIN NO. 3121

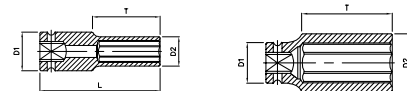

12.5
1/2"

ART. NO.	SIZE	L(MM)	D2(MM)	G	PCS/BAG
3398530	30	85	42	402	5
3398532	32	85	44	420	5
3398534	34	85	46	452	2
3398535	35	85	48	492	2
3398536	36	85	50	508	2

IMPACT CARDAN SOCKET 1/2"

DIN NO. 3121

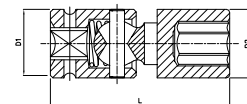

12.5
1/2"

ART. NO.	SIZE	L(MM)	D2(MM)	G	PCS/BAG
7150216	16	68	24,5	173	10
7150217	17	68	26	176	10
7150218	18	68	27	181	10
7150219	19	68	28	182	10

Sonic sockets

IMPACT SOCKET 1/2", TX

DIN NO. 3121

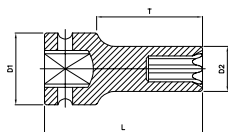

12.5
1/2"

ART. NO.	SIZE	L(MM)	D2(MM)	G	PCS/BAG
3367810	E10	78	12,45	82	5
3367811	E11	78	13,06	84	5
3367812	E12	78	14,52	88	5
3367814	E14	78	16	94	5
3367816	E16	78	19,14	118	5
3367818	E18	78	22	130	5
3367820	E20	78	23	152	5
3367822	E22	78	25	174	5
3367824	E24	78	27	214	5

IMPACT SOCKET 3/4", 6 PT.

DIN NO. 3121/3129

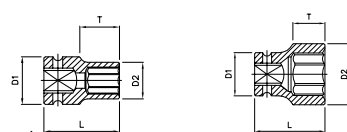

20
3/4"

ART. NO.	SIZE	L(MM)	D2(MM)	G	PCS/BAG
34517	17	51	29	328	2
34518	18	51	30	320	2
34519	19	51	32	325	2
34520	20	51	33	330	2
34521	21	51	35	340	2
34522	22	51	36	345	2
34523	23	51	38	350	2
34524	24	51	39	350	2
34525	25	54	41	360	2
34526	26	54	41	360	2
34527	27	54	42	370	2
34528	28	54	44	386	2
34529	29	54	46	410	2
34530	30	54	46	410	2
34532	32	57	48	450	2
34533	33	57	50	480	2
34534	34	57	52	490	2
34535	35	57	52	490	2
34536	36	57	54	536	2
34538	38	57	56	540	2
34539	39	57	58	540	2
34540	40	57	58	560	2
34541	41	58	60	610	2
34542	42	58	62	630	2
34543	43	63	63	670	2
34544	44	63	64	670	2
34545	45	63	66	710	2
34546	46	63	66	710	2
34547	47	68	68	800	2
34548	48	68	68	800	2
34550	50	68	71	850	2
34552	52	68	74	900	2
34554	54	73	76	950	2
34555	55	73	77	1100	2
34557	57	73	80	1200	2
34558	58	73	81	1300	2
34559	59	73	84	1400	2
34560	60	75	84	1400	2
34563	63	75	86	1600	2
34565	65	78	88	1700	2
34570	70	84	96	1900	2

DEEP IMPACT SOCKET 3/4", 6 PT.

DIN NO. 3121/3129

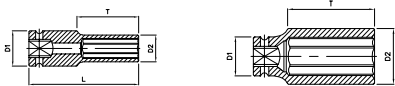

20
3/4"

ART. NO.	SIZE	L(MM)	D2(MM)	G	PCS/BAG
3459017	17	90	29	540	2
3459018	18	90	30	530	2
3459019	19	90	32	550	2
3459020	20	90	33	560	2
3459021	21	90	35	570	2
3459022	22	90	36	590	2
3459023	23	90	38	610	2
3459024	24	90	39	610	2
3459025	25	90	41	620	2
3459026	26	90	41	620	2
3459027	27	90	42	640	2
3459028	28	90	44	644	2
3459029	29	90	46	680	2
3459030	30	90	46	700	2
3459032	32	90	48	730	2
3459033	33	90	50	780	2
3459034	34	90	52	810	2
3459035	35	90	52	810	2
3459036	36	90	54	850	2
3459038	38	90	56	880	2
3459039	39	90	58	920	2
3459040	40	90	58	920	2
3459041	41	90	60	960	2
3459042	42	90	62	1050	2
3459043	43	90	63	1150	2
3459044	44	90	64	1150	2
3459045	45	90	66	1200	2
3459046	46	90	66	1200	2
3459047	47	90	68	1300	2
3459048	48	90	68	1300	2
3459050	50	90	71	1400	2
3459052	52	90	74	1600	2
3459054	54	90	76	1900	2
3459055	55	90	77	1940	2

IMPACT SOCKET 3/4", 12 PT.

DIN NO. 3121

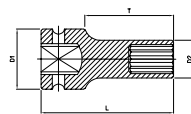

20
3/4"

ART. NO.	SIZE	L(MM)	D2(MM)	G	PCS/BAG
3499017	17	90	26	450	2
3499019	19	90	28	470	2

IMPACT SOCKET 3/4", TX

DIN NO. 3121

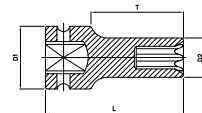

20
3/4"

ART. NO.	SIZE	L(MM)	D2(MM)	G	PCS/BAG
3469018	E18	90	22	412	2
3469020	E20	90	24	426	2
3469024	E24	90	28	500	2

Sonic sockets

IMPACT SOCKET 1", 6 PT.

DIN NO. 3121/3129

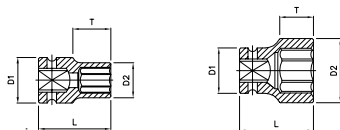

25
1"

ART. NO.	SIZE	L(MM)	D2(MM)	G	PCS/BAG
35524	24	58	42	574	2
35525	25	58	43	570	2
35526	26	58	44	570	2
35527	27	58	46	580	2
35528	28	58	46	580	2
35530	30	62	49	610	2
35532	32	62	52	660	2
35533	33	62	54	682	2
35534	34	62	54	710	2
35535	35	62	54	710	2
35536	36	65	56	720	2
35538	38	65	58	740	2
35540	40	65	60	750	2
35541	41	68	61	792	2
35542	42	68	64	850	2
35543	43	68	66	890	2
35544	44	68	67	930	2
35545	45	68	67	930	2
35546	46	72	68	1010	2
35548	48	72	70	1060	2
35550	50	75	74	1164	2
35551	51	75	74	1250	2
35552	52	75	75	1250	2
35553	53	80	76	1300	2
35554	54	80	78	1400	2
35555	55	83	80	1480	2
35557	57	83	82	1540	2
35558	58	83	84	1650	2
35559	59	87	85	1700	2
35560	60	87	86	1750	2
35563	63	87	90	1800	2
35565	65	90	92	1850	2
35566	66	90	93	1950	2
35568	68	93	95	2000	2
35570	70	93	97	2100	2
35571	71	95	101	2500	2
35575	75	95	104	2800	2
35580	80	95	112	2900	2
35585	85	100	115	3200	2
35590	90	105	124	3800	2
35595	95	105	130	5250	2

DEEP IMPACT SOCKET 1", 6 PT.

DIN NO. 3121/3129

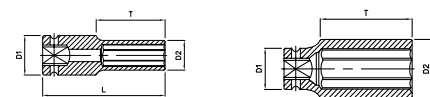

25
1"

ART. NO.	SIZE	L(MM)	D2(MM)	G	PCS/BAG
3559024	24	90.0	42.0	868	2
3559025	25	90.0	43.0	850	2
3559026	26	90.0	44.0	870	2
3559027	27	90.0	46.0	890	2
3559028	28	90.0	47.0	890	2
3559030	30	90.0	49.0	930	2
3559032	32	90.0	52.0	960	2
3559033	33	90.0	54.0	1000	2
3559034	34	90.0	54.0	1000	2
3559035	35	90.0	54.0	1000	2
3559036	36	90.0	56.0	1050	2
3559038	38	95.0	58.0	1150	2
3559040	40	95.0	60.0	1200	2
3559041	41	95.0	61.0	1220	2
3559042	42	95.0	64.0	1250	2
3559043	43	95.0	66.0	1270	2
3559044	44	95.0	67.0	1300	2
3559045	45	95.0	67.0	1300	2
3559046	46	95.0	68.0	1350	2
3559048	48	100.0	70.0	1500	2
3559050	50	100.0	74.0	1600	2
3559051	51	100.0	75.0	1650	2
3559052	52	100.0	75.0	1650	2
3559053	53	100.0	76.0	1700	2
3559054	54	100.0	78.0	1750	2
3559055	55	105.0	80.0	1900	2
3559057	57	105.0	82.0	1950	2
3559058	58	105.0	84.0	2000	2
3559059	59	110.0	85.0	2050	2
3559060	60	110.0	87.0	2100	2
3559063	63	110.0	90.0	2200	2
3559065	65	115.0	92.0	2350	2
3559066	66	115.0	93.0	2450	2
3559068	68	120.0	95.0	2550	2
3559070	70	120.0	97.0	2650	2
3559071	71	135.0	101.0	3000	2
3559075	75	135.0	104.0	4000	2
3559076	76	135.0	106.0	4000	2
3559080	80	135.0	112.0	4500	2
3559085	85	140.0	115.0	5250	2
3559090	90	140.0	124.0	5750	2
3559095	95	140.0	130.0	6300	2

SPARK PLUG SOCKET 3/8" 6 PT.

DIN NO. 3120

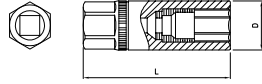

10
3/8"

ART. NO.	SIZE	L(MM)	D(MM)	G	PCS/BAG
7171216	16	65	22	94	10
7171218	18	65	26	130	10
7171221	21	65	28	136	10

SPARK PLUG SOCKET 1/2" 6 PT.

DIN NO. 3120

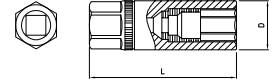

12.5
1/2"

ART. NO.	SIZE	L(MM)	D(MM)	G	PCS/BAG
7171316	16	65	22	90	10
7171318	18	65	26	140	10
7171321	21	65	28	145	10

SPARK PLUG CLIP SOCKET 3/8"

DIN NO. 3120

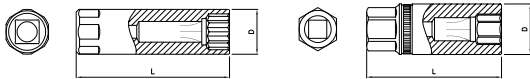

10
3/8"

ART. NO.	SIZE	L(MM)	D(MM)	G	PCS/BAG
7172214	14	63	18	58	10
7172216	16	64	22	100	10
7172218	18	64	26	158	10
7172221	21	64	28	158	10

SPARK PLUG CLIP SOCKET 1/2" 6 PT.

DIN NO. 3120

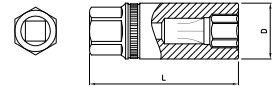

12.5
1/2"

ART. NO.	SIZE	L(MM)	D(MM)	G	PCS/BAG
7172316	16	68	22	95	10
7172318	18	68	26	155	10
7172321	21	68	28	160	10

SPARK PLUG SOCKET 3/8" 12 PT.

DIN NO. 3120

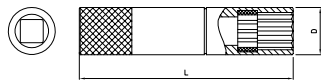

10
3/8"

ART. NO.	SIZE	L(MM)	D(MM)	G	PCS/BAG
7174214	14	90	19	104	10
7175214	14	250	19	262	10



**WORK
EFFICIENT
WORK
WITH SONIC**



SONIC WRENCHES

Minimal tolerance & maximum
torque transmission.

12 > Sonic Wrenches



> Flare nut wrench
PAGE 340



> Flare nut wrench SAE
PAGE 340



> Flexible flare nut wrench
PAGE 340



> Hinged socket wrench
PAGE 340



> Double open wrench
PAGE 341



> Double open wrench SAE
PAGE 341



> Combination wrench
PAGE 342



> Combination wrench SAE
PAGE 342



> Reversible ratcheting wrench 12pt.
PAGE 343



> Flexible ratcheting wrench 12pt.
PAGE 343



> Flat ratcheting wrench 12pt.
PAGE 343



> TX ratcheting wrench
PAGE 344



> 45° ring wrench
PAGE 344



> 75° ring wrench
PAGE 344



> 45° ring wrench SAE
PAGE 344



> Injection pump wrench
PAGE 345



> Double ring wrench
PAGE 345



> TX wrench
PAGE 345



> Half-moon wrench
PAGE 345



> Angle wrench
PAGE 345



> Adjustable wrench
PAGE 345

Torque test

Sonic wrenches meet up to more than 2.5 times the DIN standard. Sonic wrenches are made of chrome vanadium steel and manufactured under high standard industrial requirements.



SONIC TORQUE TEST

ART. NO.	DESCRIPTION	SONIC WRENCH (NM)	DIN (NM) STANDARD	ABOVE STANDARD DIN (%)
41508	Combination wrench 8	73	34.5	211.6%
41509	Combination wrench 9	95	45.4	209.3%
41510	Combination wrench 10	95	58.1	163.5%
41511	Combination wrench 11	151	72.7	207.7%
41512	Combination wrench 12	204	89.1	229.0%
41513	Combination wrench 13	218	107.0	203.7%
41514	Combination wrench 14	255	128.0	199.2%
41515	Combination wrench 15	370	150.0	246.7%
41516	Combination wrench 16	363	175.0	207.4%
41517	Combination wrench 17	484	201.0	240.8%
41518	Combination wrench 18	553	230.0	240.4%
41519	Combination wrench 19	588	261.0	225.3%
41520	Combination wrench 20	714	294.0	242.9%
41521	Combination wrench 21	1023	330.0	310.0%
41522	Combination wrench 22	899	368.0	244.3%
41523	Combination wrench 23	1082	408.0	265.2%
41524	Combination wrench 24	1032	451.0	228.8%
41525	Combination wrench 25	1316	496.0	265.3%
41526	Combination wrench 26	1443	544.0	265.3%
41527	Combination wrench 27	1629	594.0	274.2%
41528	Combination wrench 28	1623	647.0	250.9%
41529	Combination wrench 29	1650	-	-
41530	Combination wrench 30	1953	760.0	257.0%
41532	Combination wrench 32	2318	884.0	262.2%

Sonic wrenches

FLARE NUT WRENCH

DIN NO. 3118

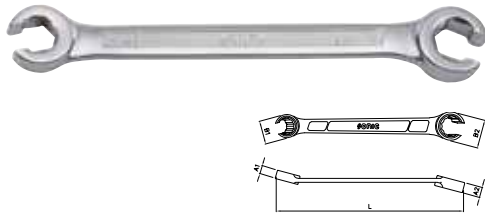

ART. NO.	SIZE	L[MM]	B1[MM]	B2[MM]	G	PCS/BAG
4110810	8x10	145	18,4	20,8	52	10
4111113	11x13	165	22,6	25	90	10
4111214	12x14	178	25	27,4	130	10

FLARE NUT WRENCH

DIN NO. 3118

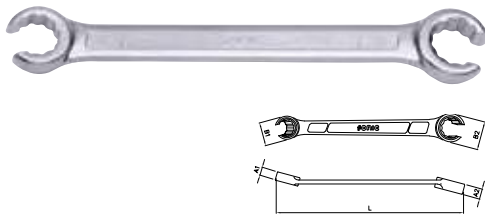

ART. NO.	SIZE	L[MM]	B1[MM]	B2[MM]	G	PCS/BAG
4111618	16x18	196	30	27,4	136	10
4111719	17x19	210	30	32,5	188	10
4111922	19x22	233	32,5	38	240	10
4112427	24x27	265	41	45	346	5
4113032	30x32	285	48,5	51	482	5

FLARE NUT WRENCH SAE

DIN NO. 3118

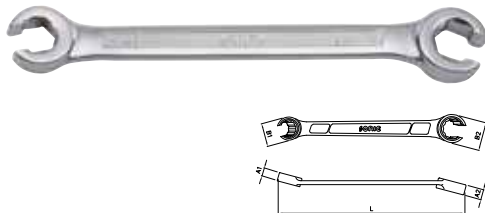

ART. NO.	SIZE	L[MM]	B1[MM]	B2[MM]	G	PCS/BAG
4250608	1/4"x5/16"	135	16,2	17,9	38	10
4251011	3/8"x7/16"	152	20,8	22,6	68	10
4251314	1/2"x9/16"	178	25	27,4	124	10
4251617	5/8"x11/16"	196	27,4	30	136	10

FLEXIBLE FLARE NUT WRENCH

DIN NO. 3118

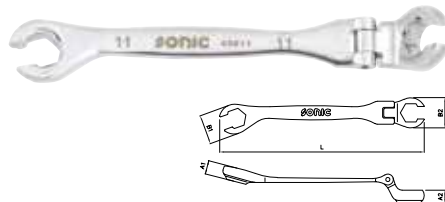

ART. NO.	SIZE	L[MM]	B1[MM]	B2[MM]	G	PCS/BAG
40808	8	128	18	18	50	10
40809	9	128	18	18	48	10
40810	10	128	18	18	48	10
40811	11	148	22	22	82	10
40812	12	148	22	22	78	10

FLEXIBLE FLARE NUT WRENCH

DIN NO. 3118

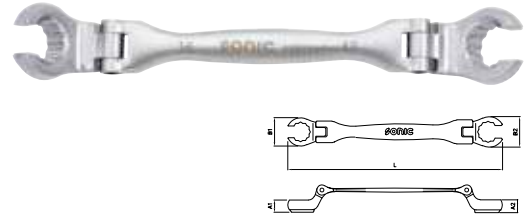

ART. NO.	SIZE	L[MM]	B1[MM]	B2[MM]	G	PCS/BAG
4080809	8x9	150	19	19	66	10
4081011	10x11	158	19	22,7	76	10
4081213	12x13	180	23	26,8	120	10

HINGED SOCKET WRENCH

DIN NO. 3118

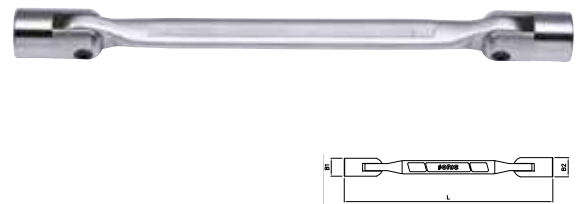

ART. NO.	SIZE	L[MM]	B1[MM]	B2[MM]	G	PCS/BAG
4120607	6x7	184	9,5	10,9	72	10
4120809	8x9	180	13	14	78	10
4121011	10x11	200	15	16	106	10
4121213	12x13	220	18	19	160	10
4121415	14x15	242	20	22	240	10
4121617	16x17	260	24	24	326	10
4121819	18x19	275	26	26	394	10
4122022	20x22	305	28	30,5	572	10
4122123	21x23	305	29,8	33	616	10
4122427	24x27	335	33	37	774	10

HINGED TX E WRENCH



ART. NO.	SIZE	L[MM]	B1[MM]	B2[MM]	G	PCS/BAG
41210608	E6xE8	183	8,3	9,9	76	10
41211012	E10xE12	201	12	15	108	10
41211418	E14xE18	220	16,3	19	202	10
41212024	E20xE24	250	22	26	334	10



HINGED DRIVER 1/4" - 1/4" IN HEX

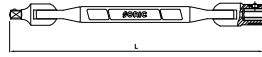

ART. NO.	SIZE	L[MM]	B1[MM]	B2[MM]	G	PCS/BAG
41201	01-apr	188	13,9	12,9	80	10

HINGED DRIVER 1/4" X 3/8"

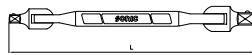

ART. NO.	SIZE	L[MM]	B1[MM]	B2[MM]	G	PCS/BAG
41202	1/4" x 3/8"	208	18	14	122	10

DOUBLE OPEN WRENCH

DIN NO. 3110

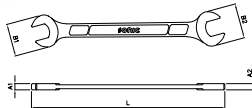

ART. NO.	SIZE	L[MM]	B1[MM]	B2[MM]	G	PCS/BAG
4140607	6x7	123	15,5	18	22	10
4140809	8x9	140	20,4	22,7	32	10
4141011	10x11	156	23,6	25,7	58	10
4141213	12x13	172	28,2	30,3	80	10
4141415	14x15	190	33,3	35,3	98	10
4141617	16x17	204	36,1	37,9	134	10
4141819	18x19	221	39,2	41,5	158	10
4142022	20x22	237	45,4	49,5	212	10
4142123	21x23	247	45,2	48,5	232	10
4142224	22x24	247	46,8	50,8	225	10
4142427	24x27	263	51,9	58,1	314	5
4142528	25x28	279	53,8	60,3	386	5
4143032	30x32	298	64,4	68,8	486	5
4143436	34x36	350	69,8	76,0	600	5

DOUBLE OPEN WRENCH SAE

DIN NO. 3110

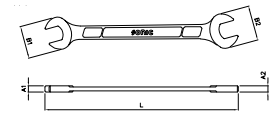

ART. NO.	SIZE	L[MM]	B1[MM]	B2[MM]	G	PCS/BAG
4220608	1/4"x5/16"	123	14,5	17,3	24	5
4221011	3/8"x7/16"	156	23,8	26	60	5
4221314	1/2"x9/16"	180	30,3	32,3	88	5
4221617	5/8"x11/16"	204	35,5	37,6	132	5
4221719	11/16"x3/4"	221	39,6	41,3	162	5
4222122	13/16"x7/8"	237	43,7	47,7	208	5
4222425	15/16"x1"	255	49,1	55,2	288	5
4222932	1.1/8"x1.1/4"	298	64	68,4	508	5

COMBINATION WRENCH

DIN NO. 3113

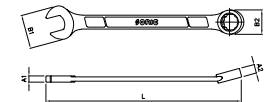

NEXT

ART. NO.	SIZE	L[MM]	B1[MM]	B2[MM]	G	PCS/BAG
41706	6	95	15,6	10,2	12	10
41707	7	115	17	11,5	18	10
41708	8	125	19,2	12,8	26	10
41709	9	135	21,2	14,2	34	10
41710	10	145	23,2	15,6	40	10
41711	11	155	25,3	16,9	50	10
41712	12	165	27,2	18,3	60	10
41713	13	175	29,4	19,7	72	10
41714	14	185	31,5	21,2	84	10
41715	15	195	33,2	22,5	100	10
41716	16	205	34,7	24	110	10
41717	17	215	36,5	25,3	146	10
41718	18	225	38,7	26,8	165	10
41719	19	235	40,7	28,1	180	10
41720	20	245	43,1	29,7	195	10
41721	21	255	44,8	31,3	217	10
41722	22	265	46,9	32,6	258	10
41723	23	275	48,3	34,2	287	10
41724	24	285	50,4	35,5	314	5
41725	25	295	52	36,9	350	5
41726	26	305	53,6	38,2	386	5
41727	27	315	55,7	39,6	443	5
41728	28	325	57,6	40,9	472	5
41729	29	335	58,3	42,3	530	5
41730	30	345	61,8	43,7	601	5
41732	32	365	65,8	46,4	697	5

Sonic wrenches

COMBINATION WRENCH

DIN NO. 3113

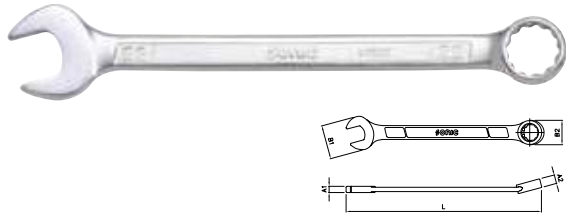

ART. NO.	SIZE	L[MM]	B1[MM]	B2[MM]	G	PCS/BAG
41506	6	105	15,5	10,1	14	10
41507	7	115	17	11,5	20	10
41508	8	125	19,2	12,8	30	10
41509	9	135	21,2	14,2	32	10
41510	10	145	23,2	15,6	38	10
41511	11	155	25,3	16,9	50	10
41512	12	165	27,2	18,3	66	10
41513	13	175	29,4	19,7	70	10
41514	14	185	31,5	21,2	84	10
41515	15	195	33,2	22,5	94	10
41516	16	205	34,7	24	108	10
41517	17	215	36,5	25,3	128	10
41518	18	225	38,7	26,8	148	10
41519	19	235	40,7	28,1	160	10
41520	20	245	43,1	29,7	178	10
41521	21	255	44,8	31,3	210	10
41522	22	265	46,9	32,6	250	10
41523	23	275	48,3	34,2	254	10
41524	24	285	50,4	35,5	328	5
41525	25	295	52	36,9	314	5
41526	26	305	53,6	38,2	348	5
41527	27	315	55,7	39,6	380	5
41528	28	325	57,6	40,9	430	5
41529	29	335	58,3	42,3	436	5
41530	30	345	61,8	43,7	530	5
41532	32	365	65,8	46,4	570	5
41533	33	380	69,2	48,8	630	2
41534	34	380	69,2	44,8	630	2
41535	35	410	74	53	800	2
41536	36	410	74	53	800	2
41538	38	430	77	56	1000	2
41541	41	460	84	61	1160	2
41543	43	460	84	61	1160	2
41546	46	500	92	66	1700	2
41548	48	540	102	73	2000	2
41550	50	540	102	73	2000	2
41555	55	560	118	86	2800	2
41558	58	600	126	94	3900	2
41560	60	600	126	94	3900	2
41565	65	680	148	108	5800	2
41570	70	680	148	108	5800	2
41575	75	730	155	115	6650	2
41580	80	730	155	115	6510	2
41585	85	790	179	131	10000	2

COMBINATION WRENCH EXTRA LONG

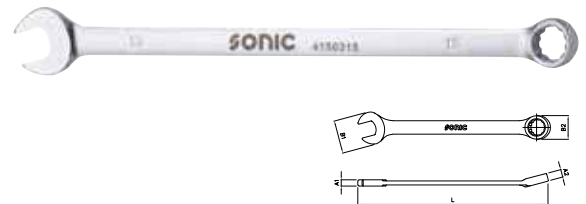

ART. NO.	SIZE	L[MM]	B1[MM]	B2[MM]	G	PCS/BAG
4150310	10	189	23,4	16,4	54	10
4150311	11	207	25,2	17,9	75	10
4150312	12	225	27,8	19,4	88	10
4150313	13	243	29,2	21	104	10
4150314	14	261	32	22,4	149	10
4150315	15	279	34,1	24	167	10
4150316	16	297	35,9	25,4	203	10
4150317	17	314	38,2	26,8	231	10
4150318	18	333	40	28,1	272	10
4150319	19	349	42,1	29,3	298	10

COMBINATION WRENCH SAE

DIN NO. 3113

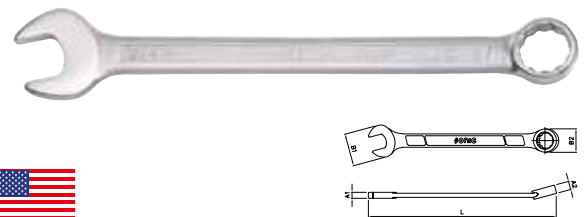

ART. NO.	SIZE	L[MM]	B1[MM]	B2[MM]	G	PCS/BAG
415206	1/4"	105	15,5	10,1	16	10
415208	5/16"	125	19,2	12,8	26	10
4152010	3/8"	145	23,2	15,6	40	10
4152011	7/16"	155	25,3	16,9	52	10
4152013	1/2"	175	29,4	19,7	70	10
4152014	9/16"	185	31,5	21,2	88	10
4152016	5/8"	205	34,7	24	114	10
4152017	11/16"	215	36,5	25,3	126	10
4152019	3/4"	235	40,7	28,1	170	10
4152021	13/16"	255	44,8	31,3	196	10
4152022	7/8"	265	46,9	32,6	218	10
4152024	15/16"	285	50,4	35,5	308	10
4152025	1"	300	52	37,5	325	10
4152027	1-1/16"	315	55,8	39	410	10
4152028	1-1/8"	335	58,5	42,2	460	10
4152032	1-1/4"	365	65	46,5	600	10
4152033	1-5/16"	380	67,2	49	640	5
4152035	1-3/8"	410	73,4	53,8	820	5
4152038	1-1/2"	430	76,6	57,8	1000	5
4152041	1-5/8"	460	83,5	61,8	1200	5

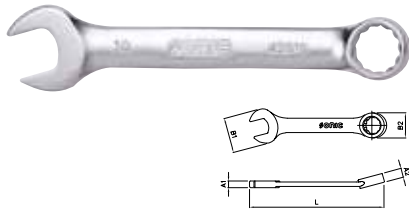
STUBBY COMBINATION WRENCH

ART. NO.	SIZE	L(MM)	B1(MM)	B2(MM)	G	PCS/BAG
42608	8	91	17,1	12,8	20	10
42609	9	97	21,4	15	30	10
42610	10	97	21,4	15	34	10
42611	11	100	23,7	17,3	44	10
42612	12	105	25,9	18,4	46	10
42613	13	108	26,8	19,7	50	10
42614	14	115	29,8	21,7	68	10
42615	15	118	31,6	22,8	80	10
42616	16	122	33,8	24,2	84	10
42617	17	130	36,2	25,4	102	10

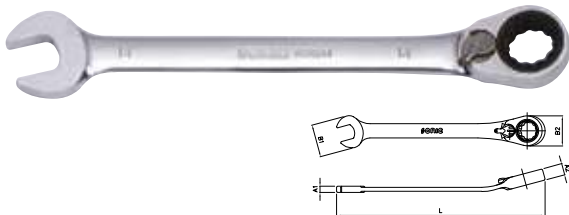
REVERSIBLE RATCHETING WRENCH 12PT.

ART. NO.	SIZE	L(MM)	B1(MM)	B2(MM)	G	PCS/BAG
4170208	8	136	16,7	17,6	36	10
4170209	9	143	19,4	19,1	44	10
4170210	10	159	21,5	20,7	58	10
4170211	11	168	23,9	22,7	70	10
4170212	12	174	26	24	84	10
4170213	13	180	27,3	26,1	100	10
4170214	14	189	31,2	27,8	116	10
4170215	15	200	32,5	29,2	140	10
4170216	16	216	34,1	31,6	158	10
4170217	17	232	37,5	33,5	200	10
4170218	18	239	39	33,7	202	10
4170219	19	247	40,7	35,1	250	10
4170221	21	285	40,7	35,1	358	10
4170222	22	285	40,7	35,1	342	10
4170224	24	325	40,7	35,1	484	10
4170227	27	359	40,7	35,1	632	10

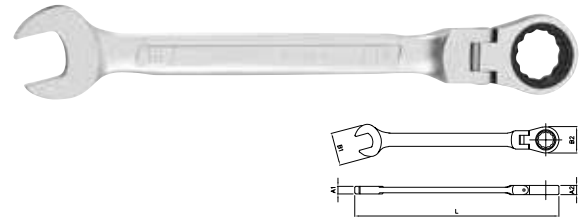
FLEXIBLE RATCHETING WRENCH 12PT.

ART. NO.	SIZE	L(MM)	B1(MM)	B2(MM)	G	PCS/BAG
4170308	8	136	17,1	17,5	38	10
4170309	9	143	19,2	19,3	44	10
4170310	10	160	21,3	21	66	10
4170311	11	168	23,7	22,7	76	10
4170312	12	174	25,8	24	92	10
4170313	13	180	26,8	26	106	10
4170314	14	193	30,4	27,7	128	10
4170315	15	200	32,1	29,1	148	10
4170316	16	216	33,8	30,7	186	10
4170317	17	233	37	32,6	218	10
4170318	18	239	38,7	33,7	226	10
4170319	19	250	40,2	34,8	268	10

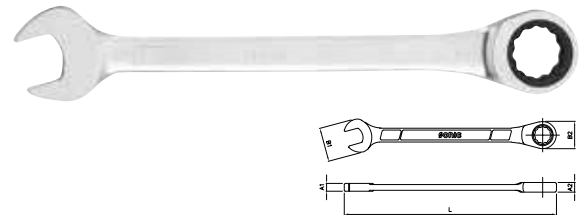
FLAT RATCHETING WRENCH 12PT.

ART. NO.	SIZE	L(MM)	B1(MM)	B2(MM)	G	PCS/BAG
4170108	8	129	18,8	18	32	10
4170109	9	139	20,8	19,5	40	10
4170110	10	149	22,8	21	50	10
4170111	11	159	24,9	23	60	10
4170112	12	169	26,8	24,5	70	10
4170113	13	179	29	26,5	88	10
4170114	14	189	31,1	28	110	10
4170115	15	199	32,8	29,5	118	10
4170116	16	209	34,3	31,5	134	10
4170117	17	219	36,1	33	168	10
4170118	18	229	38,3	34	176	10
4170119	19	239	40,3	35	204	10

Sonic wrenches

4-IN-1 RING RATCHET WRENCH

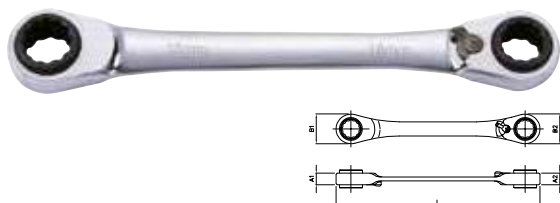

ART. NO.	SIZE	L[MM]	B1[MM]	B2[MM]	G	PCS/BAG
4170401	8-10, 12-13	160	21,5	26,5	98	5
4170402	16-17, 18-19	230	34,5	35,6	264	5

TX RATCHETING WRENCH

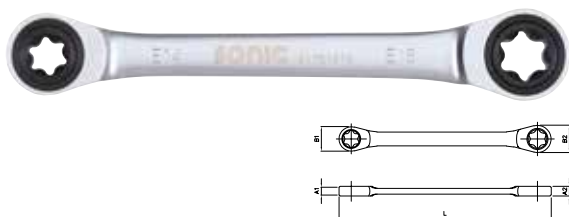

ART. NO.	SIZE	L[MM]	B1[MM]	B2[MM]	G	PCS/BAG
41760608	E6xE8	130,4	17,4	20,9	56	10
41761012	E10xE12	144,4	20,9	22,9	80	10
41761418	E14xE18	181,4	27,4	30,4	154	10
41762024	E20xE24	224,4	31,9	34,4	218	10

45° OFFSET RING WRENCH

DIN NO. 838

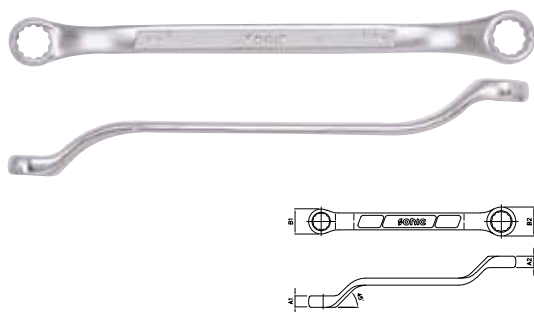

ART. NO.	SIZE	L[MM]	B1[MM]	B2[MM]	G	PCS/BAG
4180607	6x7	165	10,6	13	34	10
4180809	8x9	170	14,5	16,5	50	10
4181011	10x11	180	15	17,5	68	10
4181213	12x13	206	20	22	108	10
4181415	14x15	232	22	24	134	10
4181617	16x17	237	24	26	160	10
4181819	18x19	270	28	29,5	268	10
4182123	21x23	327	32,5	34,5	368	10

75° OFFSET RING WRENCH

DIN NO. 838

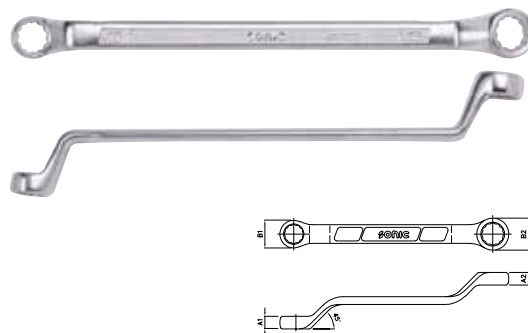

ART. NO.	SIZE	L[MM]	B1[MM]	B2[MM]	G	PCS/BAG
4190607	6x7	168	10,7	12,2	52	10
4190809	8x9	183	13,6	15,1	56	10
4191011	10x11	198	16,6	18	94	10
4191213	12x13	217	19,5	20,9	122	10
4191415	14x15	239	22,4	23,7	164	10
4191617	16x17	260	25,3	26,7	196	10
4191819	18x19	292	26,9	28,7	260	10
4192022	20x22	318	34	31,1	320	10
4192122	21x22	318	31,1	35,9	382	10
4192123	21x23	330	34	35,9	344	10
4192326	23x26	345	36,9	41,4	490	5
4192427	24x27	345	36,9	41,4	498	5
4192528	25x28	355	40,4	43,8	546	5
4193032	30x32	370	45,5	48,5	632	5
4193436	34x36	415	48,5	54,5	1000	5

45° OFFSET RING WRENCH SAE

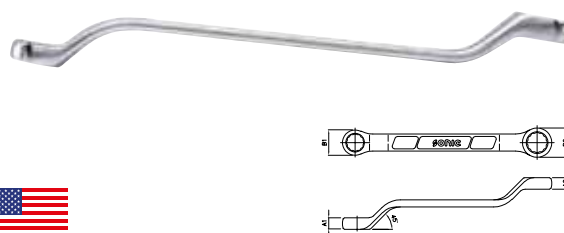

ART. NO.	SIZE	L[MM]	B1[MM]	B2[MM]	G	PCS/BAG
4270608	1/4"x5/16"	165	10,6	13	36	5
4271011	3/8"x7/16"	180	15	17,5	68	5
4271314	1/2"x9/16"	206	20	22	100	5
4271416	9/16"x5/8"	232	22	25,3	150	5
4271719	11/16"x3/4"	270	28	29,5	256	5
4272122	13/16"x7/8"	327	32,5	34,5	368	5
4272425	15/16"x1"	362	34,5	38,5	478	5

INJECTION PUMP WRENCH

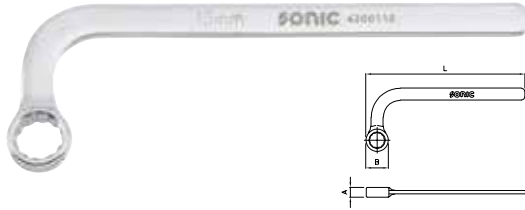

ART. NO.	SIZE	L[MM]	B[MM]	G	PCS/BAG
4200113	13	160	20,6	76	5

FLAT DOUBLE RING WRENCH

DIN NO. 837



ART. NO.	SIZE	L[MM]	B1[MM]	B2[MM]	G	PCS/BAG
4200607	6x7	119	9,8	11	16	5
4200809	8x9	135	12,9	16,5	26	5
4201011	10x11	153	16,5	19,8	44	5
4201213	12x13	162	19,8	22	62	5
4201415	14x15	180	22	25	86	5
4201617	16x17	210	25	26,5	118	5
4201819	18x19	225	27,6	28,6	140	5

TX WRENCH



ART. NO.	SIZE	L[MM]	B1[MM]	B2[MM]	G	PCS/BAG
4160608	E6xE8	113	9,2	11,2	22	10
4160711	E7xE11	127	10,6	15,6	24	10
4161012	E10xE12	142	14,4	16,7	42	10
4161418	E14xE18	182	17,2	21,2	82	10
4161622	E16xE22	202	18,9	25,9	116	10
4162024	E20xE24	224	24,8	28,7	200	10

HALF-MOON WRENCH



ART. NO.	SIZE	L[MM]	B1[MM]	B2[MM]	G	PCS/BAG
4211012	10x12	141	15,6	18,2	54	5
4211113	11x13	166	18,2	21	96	5
4211417	14x17	190	22	25	128	5

ANGLE WRENCH 6 PT.

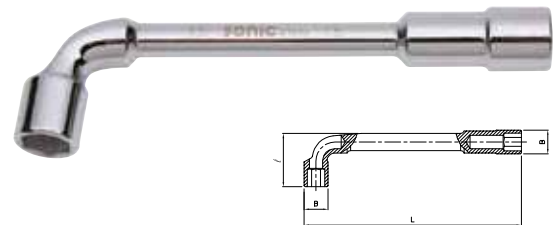

ART. NO.	SIZE	L[MM]	I[MM]	B[MM]	G	PCS/BAG
41308	8	127	29	11,9	68	10
41310	10	140	36	14,8	114	10
41311	11	141	37	15,9	116	10
41312	12	150	42	16,9	152	10
41313	13	153	42	20	180	10
41314	14	170	47	20,9	212	10
41315	15	175	48	21,9	226	10
41316	16	195	53	23,9	330	10
41317	17	198	54	25,4	348	10
41318	18	210	57	26,4	400	10
41319	19	213	58	28,4	432	10

ADJUSTABLE WRENCH



ART. NO.	L[MM]	G	PCS/BAG
42301150	155	147	10
42301200	205	275	10
42301250	255	410	10
42301300	305	765	10
42301375	385	1330	10

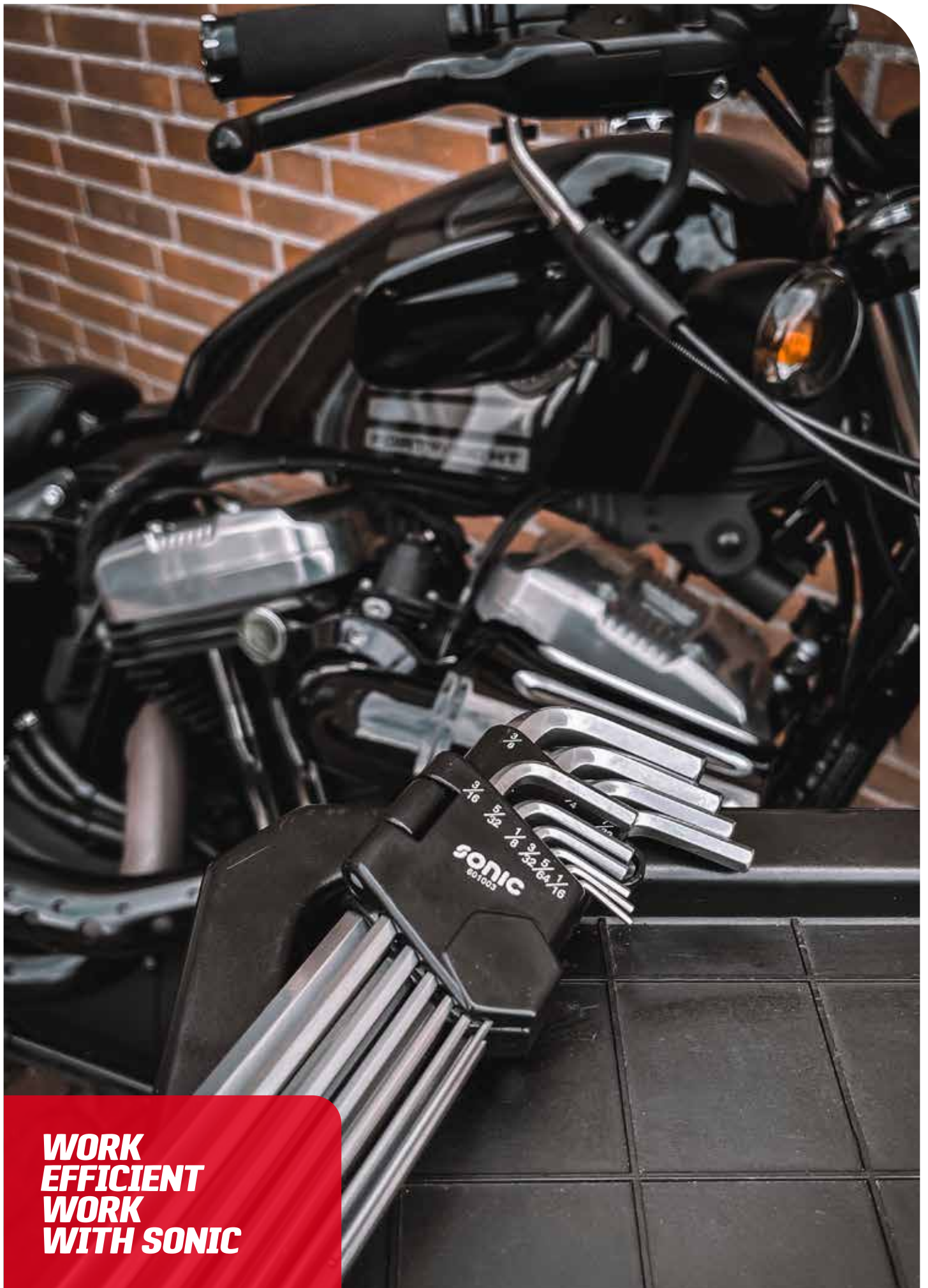

13

**WORK
EFFICIENT
WORK
WITH SONIC**



SONIC HEX AND TX KEYS

Great rotation & maximum torque.

13 > Sonic Hex and TX keys



> Foldable hex key sets
PAGE 349



> Foldable TX key sets
PAGE 350



> Foldable hex key sets SAE
PAGE 349



> TX key sets
PAGE 351



> Hex key sets
PAGE 349



> TX ball key sets
PAGE 351



> Hex ball key sets
PAGE 350



> Hex key wrench
PAGE 352



> Hex ball key sets SAE
PAGE 350



> TX key wrench
PAGE 353

600713 - FOLDABLE HEX KEY SET, 7-PCS



PCS	DESCRIPTION
7	2,5, 3, 4, 5, 6, 8, 10mm

601007 - HEX KEY SET EXTRA LONG, 10-PCS



ART. NR.	PCS	DESCRIPTION
184030127...10	10	Hex extra long key 1.27, 1.5, 2, 2.5, 3, 4, 5, 6, 8, 10mm

600712 - FOLDABLE HEX KEY SET, 7-PCS (AVAILABLE IN 16-PCS DISPLAY)



PCS	DESCRIPTION
7	2, 2.5, 3, 4, 5, 6, 8mm

600925 - COLORED HEX KEY SET EXTRA LONG, 9-PCS



PCS	DESCRIPTION
9	1.5, 2, 2.5, 3, 4, 5, 6, 8, 10mm

600716 - FOLDABLE HEX KEY SET, 7-PCS (AVAILABLE IN 16-PCS DISPLAY)



PCS	DESCRIPTION
7	2,5, 3, 4, 5, 6, 8, 10mm

600831 - LONG HEX KEY WRENCH SET, 8-PCS



PCS	DESCRIPTION
10	2, 2.5, 3, 4, 5, 6, 8, 10mm

600927 - FOLDABLE HEX KEY SET SAE, 9-PCS (AVAILABLE IN 16-PCS DISPLAY)



PCS	DESCRIPTION
9	1/16", 5/64", 3/32", 7/64", 1/8", 5/32", 3/16", 7/32", 1/4"



600621 - HEX KEY SET 600MML, 6-PCS

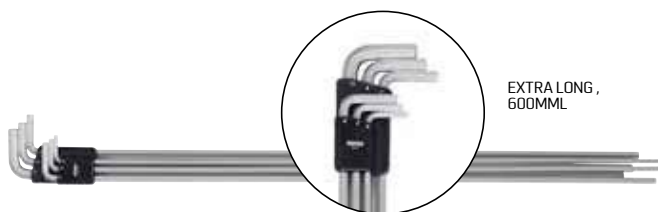

PCS	DESCRIPTION
6	4, 5, 6, 7, 8, 10mm

Sonic Hex and TX keys

600912 - HEX BALL STUBBY KEY SET, 9-PCS



PCS	DESCRIPTION
9	1.5, 2, 2.5, 3, 4, 5, 6, 8, 10mm

601006 - HEX BALL KEY SET, 10-PCS

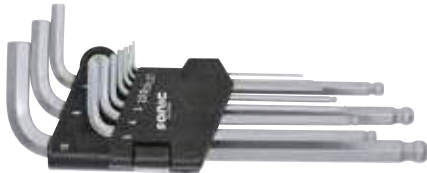

ART. NR.	PCS	DESCRIPTION
185020127...10	10	Hex ball long key 1.27, 1.5, 2, 2.5, 3, 4, 5, 6, 8, 10mm

601008 - HEX BALL KEY SET EXTRA LONG 10-PCS

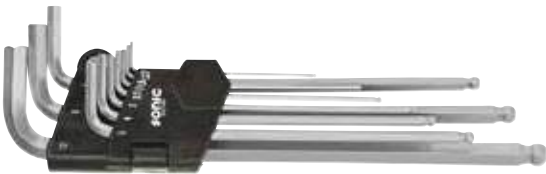

ART. NR.	PCS	DESCRIPTION
185030127...10	10	Hex extra long key 1.27, 1.5, 2, 2.5, 3, 4, 5, 6, 8, 10mm

601003 - HEX KEY SET EXTRA LONG (SAE), 10-PCS

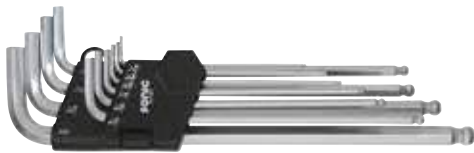

ART. NR.	PCS	DESCRIPTION
1850601...10	10	1/16", 5/64", 3/32", 1/8", 5/32", 3/16", 7/32", 1/4", 5/16", 3/8"

600931 - BALL KEY WRENCH SET EXTRA LONG, MAGNETIC, 9-PCS



PCS	DESCRIPTION
9	1.5, 2, 2.5, 3, 4, 5, 6, 8, 10mm

601305 - BALL ENDED HEX KEY SET WITH MAGNET, 13-PCS



- MAGNETIC
- EXTREME BIG SIZES

PCS	DESCRIPTION
9	1.5, 2, 2.5, 3, 4, 5, 6, 8, 10mm

601306 - BALL ENDED HEX KEY SET SAE WITH MAGNET, 13-PCS

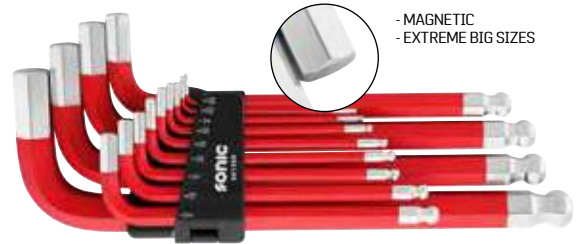

- MAGNETIC
- EXTREME BIG SIZES



PCS	DESCRIPTION
13	5/64, 3/32, 1/8, 5/32, 3/16, 7/32, 1/4, 5/16, 3/8, 1/2, 9/16, 5/8, 3/4"

600923 - COLORED STUBBY BALL HEX KEY SET, 9-PCS



PCS	DESCRIPTION
9	1.5, 2, 2.5, 3, 4, 5, 6, 8, 10mm

600830 - FOLDABLE TX KEY SET, 8-PCS (AVAILABLE IN 16-PCS DISPLAY)



PCS	DESCRIPTION
8	T8, T10, T15, T20, T25, T27, T30, T40

600813 - FOLDABLE TX KEY SET, 8-PCS



PCS	DESCRIPTION
8	T8, T10, T15, T20, T25, T27, T30, T40

601307 - TX KEY SET WITH MAGNET, 13-PCS

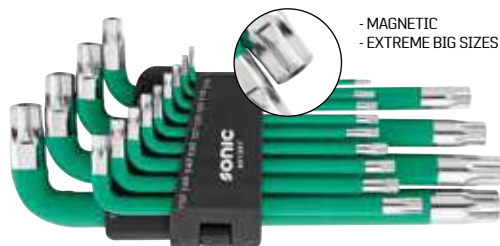

- MAGNETIC
- EXTREME BIG SIZES

PCS	DESCRIPTION
13	T10, T15, T20, T25, T27, T30, T40, T45, T50, T55, T60, T70, T80

600924 - COLORED STUBBY TX-H KEY SET, 9-PCS



PCS	DESCRIPTION
9	T10H, T15H, T20H, T25H, T27H, T30H, T40H, T45H, T50H

600909 - TX BALL EXTRA LONG KEY SET, 9-PCS



ART. NR.	PCS	DESCRIPTION
1861310...350	9	T10, T15, T20, T25, T27, T30, T40, T45, T50

600622 - TX KEY SET 600MML, 6-PCS



600902 - TX KEY SET EXTRA LONG, 9-PCS



ART. NR.	PCS	DESCRIPTION
1860310...50	9	T10, T15, T20, T25, T27, T30, T40, T45, T50

600926 - COLORED TX KEY SET EXTRA LONG, 9-PCS



PCS	DESCRIPTION
9	T10, T15, T20, T25, T27, T30, T40, T45, T50



EXTRA LONG,
600MML

PCS	DESCRIPTION
6	T20, T25, T30, T40, T45, T50

Sonic Hex and TX keys

BALL ENDED HEX KEY WRENCH

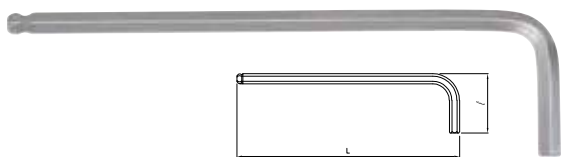

ART. NO.	SIZE	L[MM]	I[MM]	G	PCS/BAG
185020127	1,27	63	13	2	10
18502015	1,5	63	16	2	10
1850202	2	75	18	2	10
18502025	2,5	88	21	4	10
1850203	3	92	22	6	10
1850204	4	103	29	14	10
1850205	5	118	32	24	10
1850206	6	140	38	40	10
1850208	8	158	44	82	10
1850210	10	180	50	142	10

BALL ENDED HEX KEY WRENCH, EXTRA LONG

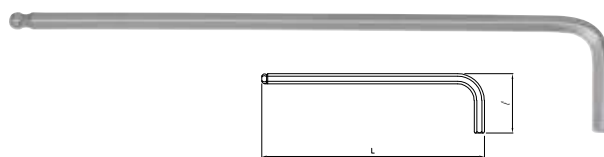

ART. NO.	SIZE	L[MM]	I[MM]	G	PCS/BAG
185030127	1,27	81	13	2	10
18503015	1,5	92	16	2	10
1850302	2	102	18	4	10
18503025	2,5	115	21	6	10
1850303	3	129	22	8	10
1850304	4	144	29	18	10
1850305	5	165	32	30	10
1850306	6	185	38	50	10
1850308	8	208	44	98	10
1850310	10	232	50	176	10

HEX KEY WRENCH, EXTRA LONG

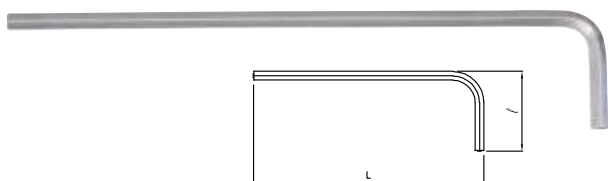

ART. NO.	SIZE	L[MM]	I[MM]	G	PCS/BAG
184030127	1,27	81	13	2	10
18403015	1,5	92	16	2	10
1840302	2	102	18	2	10
18403025	2,5	115	21	6	10
1840303	3	129	22	8	10
1840304	4	144	29	18	10
1840305	5	165	32	32	10
1840306	6	185	38	50	10
1840308	8	208	44	102	10
1840310	10	232	50	176	10

BALL ENDED HEX KEY WRENCH, EXTRA LONG (SAE)

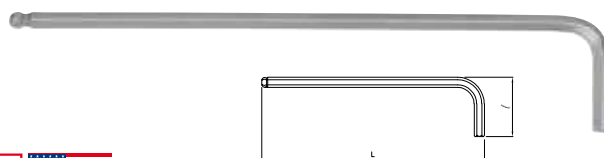

ART. NO.	SIZE	L[MM]	I[MM]	G	PCS/BAG
1850601	1/16"	81	13	2	10
1850602	5/64"	92	16	2	10
1850603	3/32"	102	18	4	10
1850604	1/8"	115	21	6	10
1850605	5/32"	129	22	8	10
1850606	3/16"	144	29	18	10
1850607	7/32"	165	32	30	10
1850608	1/4"	185	38	50	10
1850609	5/16"	208	44	98	10
1850610	3/8"	232	50	176	10

TX KEY WRENCH, EXTRA LONG KEY

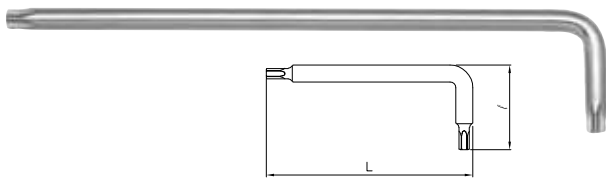

ART. NO.	SIZE	L[MM]	l[MM]	G	PCS/BAG
1860310	T10	92	16	6	10
1860315	T15	102	18	8	10
1860320	T20	115	21	12	10
1860325	T25	129	22	18	10
1860327	T27	144	29	26	10
1860330	T30	165	32	40	10
1860340	T40	186	38	62	10
1860345	T45	208	44	90	10
1860350	T50	232	50	128	10

TX KEY WRENCH, EXTRA LONG

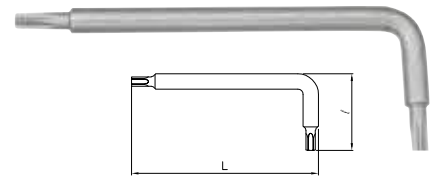

ART. NO.	SIZE	L[MM]	l[MM]	G	PCS/BAG
1860106	T6	45	20	2	10
1860107	T7	50	20	4	10
1860108	T8	51	20	4	10
1860109	T9	53	18	4	10

601908 - TWIN TYPE LONG BALL POINT HEX KEY & TX-H KEY WRENCH SET, 18-PCS



BALL ENDED TX KEY WRENCH TX, EXTRA LONG

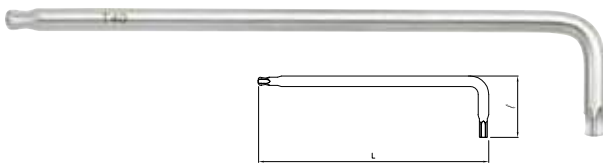

ART. NO.	SIZE	L[MM]	l[MM]	G	PCS/BAG
1861310	T10	92	16	4	10
1861315	T15	102	18	8	10
1861320	T20	115	21	12	10
1861325	T25	129	22	18	10
1861327	T27	144	29	24	10
1861330	T30	165	32	38	10
1861340	T40	185	38	60	10
1861345	T45	208	44	88	10
1861350	T50	232	50	124	10



PCS	DESCRIPTION
9	1.5, 2, 2.5, 3, 4, 5, 6, 8, 10mm
9	T10, T15, T20, T25, T27, T30, T40, T45, T50

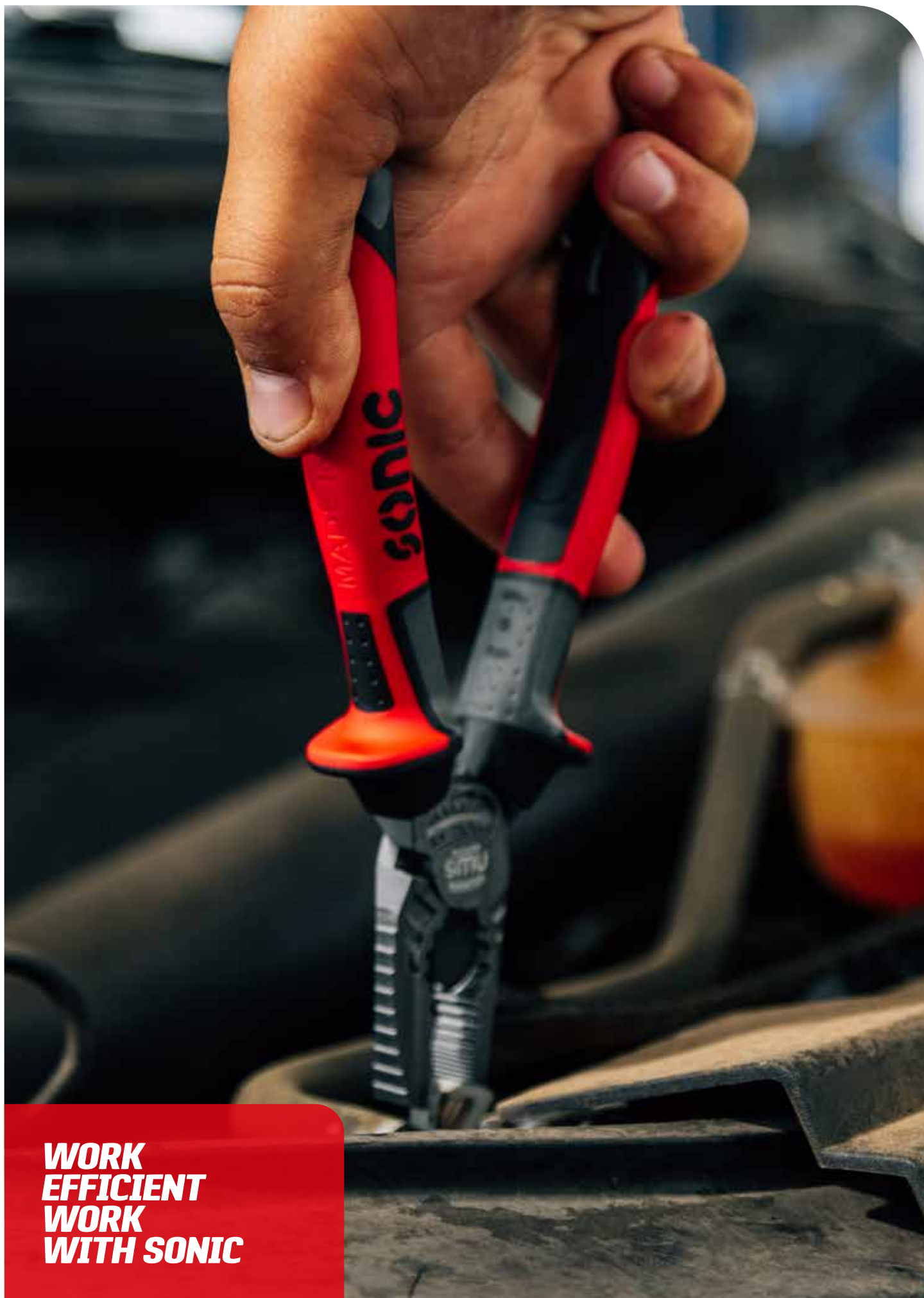



**WORK
EFFICIENT
WORK
WITH SONIC**



SONIC PLIERS

Ultimate strength & durability.

14 > Sonic pliers, hammers, chisels, files, measuring and cutting tools

-  > Combination pliers
PAGE 357
-  > Long nose pliers
PAGE 357
-  > Bent long nose pliers
PAGE 357
-  > Diagonal pliers
PAGE 357
-  > VDE pliers
PAGE 357, 358
-  > Stripping pliers
PAGE 358
-  > Waterpump pliers
PAGE 358
-  > Tower pincers
PAGE 358
-  > Snap ring pliers
PAGE 359
-  > Pliers extra long
PAGE 359
-  > Spark plug pliers
PAGE 359, 360
-  > Grip pliers
PAGE 360
-  > Hose clamp pliers
PAGE 361
-  > Wheel pliers
PAGE 361
-  > Riveting pliers
PAGE 361
-  > Oil filter pliers
PAGE 361
-  > Pin punch set
PAGE 361
-  > Chisels
PAGE 362
-  > Pin punches
PAGE 362
-  > Center punches
PAGE 361
-  > Hammers
PAGE 365
-  > Saws
PAGE 365
-  > Shears
PAGE 365
-  > Knives
PAGE 366
-  > Files
PAGE 366
-  > Triangular scrapers
PAGE 366
-  > Wire brushes
PAGE 367
-  > Feeler gauge
PAGE 367
-  > Rulers
PAGE 367
-  > Calipers
PAGE 367
-  > Measuring tape
PAGE 367
-  > Panel removers
PAGE 368
-  > Scrapers
PAGE 368
-  > Hooks
PAGE 369
-  > Magnet pickups
PAGE 370
-  > Mirror
PAGE 370
-  > Pry bars
PAGE 370

COMBINATION PLIERS 6"



ART. NO.	L(MM)	G	PCS/BAG
4311165	165	180	6

LONG NOSE PLIERS 8"



ART. NO.	L(MM)	G	PCS/BAG
4321200	200	198	10

COMBINATION PLIERS 7"



ART. NO.	L(MM)	G	PCS/BAG
4311175	190	248	10

VDE LONG NOSE PLIERS 8"



ART. NO.	L(MM)	G	PCS/BAG
4322200	205	220	10

ERGONOMIC POWER-COMBINATION PLIERS 8"



ART. NO.	L(MM)	G	PCS/BAG
4312200	180	268	10

BENT LONG NOSE PLIERS 8"



ART. NO.	L(MM)	G	PCS/BAG
4331200	195	198	10

VDE COMBINATION PLIERS



ART. NO.	L(MM)	G	PCS/BAG
4312180	185	260	10

DIAGONAL PLIERS 5"

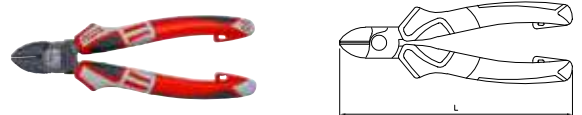

ART. NO.	L(MM)	G	PCS/BAG
4341145	155	158	6

FLAT LONG NOSE PLIERS 6"



ART. NO.	L(MM)	G	PCS/BAG
4321160	170	152	6

DIAGONAL PLIERS 7"



ART. NO.	L(MM)	G	PCS/BAG
4341175	170	200	10

FLAT LONG NOSE PLIERS 6"



ART. NO.	L(MM)	G	PCS/BAG
4322160	170	160	6

DIAGONAL PLIERS 7"



ART. NO.	L(MM)	G	PCS/BAG
4341180	190	236	6

LONG NOSE PLIERS 6"



ART. NO.	L(MM)	G	PCS/BAG
4321170	170	150	6

UNIVERSAL DIAGONAL PLIERS



ART. NO.	L(MM)	G	PCS/BAG
4341190	195	250	6

Sonic pliers, hammers, chisels, files, measuring and cutting tools

LEVERAGE DIAGONAL PLIERS 8"

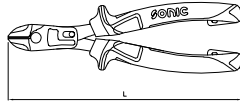

ART. NO.	L(MM)	G	PCS/BAG
4342200	210	308	10

LEVERAGE DIAGONAL PLIERS 9"

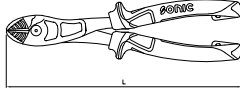

ART. NO.	L(MM)	G	PCS/BAG
4342240	250	410	10

HEAVY DUTY DIAGONAL PLIERS 8"

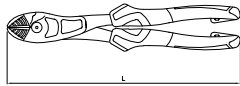

ART. NO.	L(MM)	G	PCS/BAG
4343200	210	290	6

VDE DIAGONAL PLIERS 6"

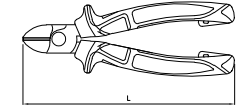

ART. NO.	L(MM)	G	PCS/BAG
4342160	165	210	10

VDE STRIPPING PLIERS

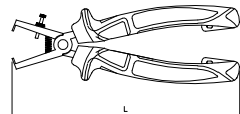

ART. NO.	L(MM)	G	PCS/BAG
4472160	160	185	10

WIRE STRIPPER 8"

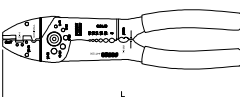

ART. NO.	L(MM)	G	PCS/BAG
4471250	215	186	10

AUTOMATIC WIRE STRIPPER 0.5 - 4MM

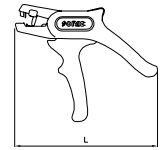

ART. NO.	L(MM)	G	PCS/BAG
4471180	180	130	10

WIRE STRIPPER 0.2-6.0MM



- Stripping and cutting of cables and wires with $\varnothing 0,05-6\text{mm}^2$, adjustable by setting wheel
- Crimping of $0,2-6\text{mm}^2$ isolated cable shoes
- Crimping of $0,2-6\text{mm}^2$ uninsulated cable shoes
- Crimping of $7-8\text{mm}^2$ ignition cable contacts
- With one operation each position of the cable can be stripped

ART. NO.	L(MM)	G	PCS/BAG
813003	280	316	1

WATERPUMP PLIERS

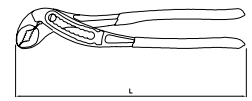

ART. NO.	L(MM)	G	PCS/BAG
4351180	180	145	10
4351250	250	322	10
4351300	300	580	10
4351400	400	1305	10

WATERPUMP PLIERS MX

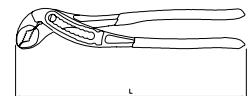

ART. NO.	L(MM)	G	PCS/BAG
4352180	280	200	10
4352250	250	340	10
4352400	400	1065	10

TOWER PINCERS

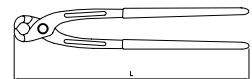

ART. NO.	L(MM)	G	PCS/BAG
44601280	280	436	1

**SNAP RING PLIERS (STRAIGHT OPEN)
Ø 19-60MM**



ART. NO.	L[MM]	G	PCS/BAG
43611	178	150	10

**SNAP RING PLIERS (STRAIGHT OPEN)
Ø 40-100MM**



ART. NO.	L[MM]	G	PCS/BAG
4393005	220	238	10

LONG NOSE PLIERS STRAIGHT 11"



ART. NO.	L[MM]	G	PCS/BAG
4323275	284	295	5

**SNAP RING PLIERS (STRAIGHT CLOSE)
Ø 19-60MM**



ART. NO.	L[MM]	G	PCS/BAG
43612	178	150	10

**SNAP RING PLIERS (STRAIGHT CLOSE)
Ø 40-100MM**



ART. NO.	L[MM]	G	PCS/BAG
4393004	220	232	10

LONG NOSE PLIERS 10" 90° BENT



ART. NO.	L[MM]	G	PCS/BAG
4333270	257	290	5

**SNAP RING PLIERS (BENT OPEN)
Ø 19-60MM**



ART. NO.	L[MM]	G	PCS/BAG
43613	167	150	10

**SNAP RING PLIERS (BENT OPEN)
Ø 40-100MM**



ART. NO.	L[MM]	G	PCS/BAG
4393007	200	242	10

LONG NOSE PLIERS 11" 45° BENT



ART. NO.	L[MM]	G	PCS/BAG
4333275	275	287	5

**SNAP RING PLIERS (BENT CLOSE)
Ø 19-60MM**



ART. NO.	L[MM]	G	PCS/BAG
43614	167	150	10

**SNAP RING PLIERS (BENT CLOSE)
Ø 40-100MM**



ART. NO.	L[MM]	G	PCS/BAG
4393006	200	236	10

CIRCLE NOSE PLIERS 11"



ART. NO.	L[MM]	G	PCS/BAG
4393001	291	313	5
4393002	291	321	5
4393003	295	317	5

LOCK RING PLIERS



ART. NO.	L[MM]	G	PCS/BAG
830001	220	190	1

FLAT NOSE PLIERS ESD



ART. NO.	L[MM]	G	PCS/BAG
4324115	115	70	1

CHAIN NOSE PLIERS ESD



ART. NO.	L[MM]	G	PCS/BAG
4325115	115	70	1

SIDE CUTTER ESD



ART. NO.	L[MM]	G	PCS/BAG
4344115	115	80	1
4345115	115	70	1

SCISSOR JOINTED PLIERS, EXTRA LONG



ART. NO.	L[MM]	G	PCS/BAG
4476006	340	396	10

SCISSOR JOINTED PLIERS, EXTRA LONG 45° BENT



ART. NO.	L[MM]	G	PCS/BAG
4476007	336	396	10

GLOW PLUG PLIERS BENT



ART. NO.	L[MM]	G	PCS/BAG
4476004	240	240	10

SPARK PLUG PLIERS



ART. NO.	L[MM]	G	PCS/BAG
4476005	290	302	10

Sonic pliers, hammers, chisels, files, measuring and cutting tools

SPARK PLUG CONNECTOR PLIERS



ART. NO.	L(MM)	G	PCS/BAG
4476002	290	267	10

SPARK PLUG CONNECTOR PLIERS (RING)



ART. NO.	L(MM)	G	PCS/BAG
4476001	290	240	10

LOCKING PLIERS



ART. NO.	L(MM)	G	PCS/BAG
4380250	230	570	10

LONG NOSE LOCKING PLIERS



ART. NO.	L(MM)	G	PCS/BAG
4381150	170	190	5
4381225	220	376	5

CURVED JAW LOCKING PLIERS



ART. NO.	L(MM)	G	PCS/BAG
4382125	145	178	5
4382175	190	345	5
4382250	225	552	5

STRAIGHT JAW LOCKING PLIERS



ART. NO.	L(MM)	G	PCS/BAG
4383175	190	376	5
4383250	230	578	5

V CURVED JAW LOCKING PLIERS



ART. NO.	L(MM)	G	PCS/BAG
4384250	230	572	10

PAD LOCKING C CLAMP PLIERS



ART. NO.	L(MM)	G	PCS/BAG
4385150	175	274	5
4385275	285	798	5

DOT LOCKING C CLAMP



ART. NO.	L(MM)	G	PCS/BAG
4386150	170	232	5
4386275	275	802	5

LOCKING PLIERS



ART. NO.	L(MM)	G	PCS/BAG
4387250	245	708	5

WELDER'S GRIP PLIERS



ART. NO.	L(MM)	G	PCS/BAG
4388275	270	864	5

LOCKING PLIERS FOR BRAKE AND AIR PLUG



ART. NO.	L(MM)	G	PCS/BAG
4391175	200	366	5

HOSE CLAMP PLIERS



ART. NO.	L(MM)	G	PCS/BAG
4473001	215	208	1

WHEEL WEIGHT BALANCE PLIERS



To remove adhesive weights for alloy wheels. Through its unique design in the basin, the removal of all kinds of adhesive weight can be done very easily and without damage to alloy rims.

ART. NO.	L(MM)	G	PCS/BAG
4474002	230	536	1

FLAT BAND HOSE CLAMP PLIERS



ART. NO.	L(MM)	G	PCS/BAG
4473002	215	208	1

RIVETING PLIERS



ART. NO.	L(MM)	G	PCS/BAG
4410265	260	480	24

ANGLED FLAT BAND HOSE CLAMP PLIERS



ART. NO.	L(MM)	G	PCS/BAG
4473004	215	186	1

OIL FILTER PLIERS



ART. NO.	L(MM)	G	PCS/BAG
4450250	260	396	5
4450300	305	466	5

HOSE CLIP PLIER



ART. NO.	L(MM)	G	PCS/BAG
4473003	175	228	1

PIPE WRENCH 90°



ART. NO.	L(MM)	G	PCS/BAG
47034340	310	785	1
47034550	560	376	1
47034680	650	3450	1

HOSE CLAMP PLIER (ANGLE TYPE)



ART. NO.	L(MM)	G	PCS/BAG
4473005	180	244	1

PLASTIC PIPE CUTTER



ART. NO.	L(MM)	G	PCS/BAG
47033	210	785	1

WHEEL WEIGHT BALANCE PLIERS



ART. NO.	L(MM)	G	PCS/BAG
4474001	240	394	1



***SONIC
PUNCHES
AND
CHISELS***

Strength, accuracy & durability.

GRIP CHISEL

ART. NO.	L(MM)	G	PCS/BAG
45110141	140	60	10
45112160	160	96	10
45116170	170	116	10
45118190	190	196	10
45124220	220	350	10

GRIP TAPER PUNCH

ART. NO.	L(MM)	G	PCS/BAG
4552185	185	98	10
4553185	185	100	10
4554185	185	102	10

GRIP CAPE CHISEL

ART. NO.	L(MM)	G	PCS/BAG
4527190	190	186	10

GRIP CENTER PUNCH

ART. NO.	L(MM)	G	PCS/BAG
4564185	185	102	10

FLAT CHISEL

ART. NO.	L(MM)	G	PCS/BAG
4831101	240	370	1

AUTO CENTER PUNCH



ART. NO.	L(MM)	W(MM)	G	PCS/BAG
45602	155	37	134	10

GRIP PIN PUNCH

ART. NO.	L(MM)	G	PCS/BAG
4532140	140	50	10
4533150	150	54	10
4534180	180	88	10
4535200	200	102	10
4536210	210	182	10
4538220	220	176	10

600624 - PIN PUNCH SET 6-PCS

ART. NR.	PCS	DESCRIPTION
4532115...8180	6	Pin punch 115mml 2, 125mml 3, 150mml 4, 165mml 5, 180mml 6, 180mml 8

 Made in Italy



SONIC HAMMERS

Safety, durability & strength.

MACHINIST HAMMER WITH ASH HANDLE



ART. NO.	L(MM)	G	PCS/BAG
4611200	287	262	5
4611400	311	512	5
4640500	347	630	5
4640600	360	760	5
4640800	383	994	5
4621000	366	1166	5
4641500	422	1672	5
4642000	447	2170	5

STONING HAMMER WITH ASH HANDLE



ART. NO.	L(MM)	G	PCS/BAG
4631000	278	1106	5

INSTALL HAMMER SOFT/HARD, WITH ASH HANDLE



ART. NO.	L(MM)	G	PCS/BAG
4822102	97	366	5
4620400	290	608	5

ANTI REBOUND HAMMER, WITH ASH HANDLE



ART. NO.	L(MM)	G	PCS/BAG
4652035	330	610	5
4652060	355	1340	5

ROUND HEAD HAMMER WITH ASH HANDLE



ART. NO.	L(MM)	G	PCS/BAG
4822503	320	454	1

HACKSAW



ART. NO.	L(MM)	G	PCS/BAG
46601	415	962	5

SPARE BLADES 3-PCS FOR MINI HACKSAW 46602



ART. NO.	L(MM)	G	PCS/BAG
46603	153	8	3

MINI HACKSAW



ART. NO.	L(MM)	G	PCS/BAG
46602	270	218	10

SHEARS



ART. NO.	TYPE	L(MM)	G	PCS/BAG
46702	left	185	210	5
46703	right	185	210	5

SHEARS



ART. NO.	L(MM)	G	PCS/BAG
46701	262	484	5

COMBICISSOR



ART. NO.	L(MM)	G	PCS/BAG
46704	190	235	1

Sonic pliers, hammers, chisels, files, measuring and cutting tools

UTILITY KNIFE (INCL. 10 BLADES)



ART. NO.	L(MM)	G	PCS/BAG
46806	262	484	5

10-PCS SPARE BLADES IN HOLDER FOR UTILITY KNIFE 46806



ART. NO.	L(MM)	G	PCS/BAG
46806-1	119	76	100

UTILITY KNIFE (INCL. 13 BLADES)



ART. NO.	L(MM)	G	PCS/BAG
46807	164	184	10

10-PCS SPARE BLADES IN HOLDER FOR UTILITY KNIFE 46807



ART. NO.	L(MM)	G	PCS/BAG
46807-1	68	48	100

UNIVERSAL KNIFE



ART. NO.	L(MM)	G	PCS/BAG
46804	155	144	8

Also available in display with 8-pcs



FLAT FILE 8"



ART. NO.	L1(MM)	L2(MM)	L(MM)	G	PCS/BAG
46911	205	115	320	190	10

HALF ROUND FILE 8"



ART. NO.	L1(MM)	L2(MM)	L(MM)	G	PCS/BAG
46912	205	115	320	206	10

ROUND FILE 8"



ART. NO.	L1(MM)	L2(MM)	L(MM)	G	PCS/BAG
46913	205	115	320	138	10

TRIANGULAR FILE 8"



ART. NO.	L1(MM)	L2(MM)	L(MM)	G	PCS/BAG
46914	205	115	320	188	10

TRIANGULAR FILE FOR BRAKES 8"



ART. NO.	L1(MM)	L2(MM)	L(MM)	G	PCS/BAG
46905	155	115	270	170	10

TRIANGULAR HOLLOW SHAPE SCRAPER



ART. NO.	L(MM)	G	PCS/BAG
47824	275	122	10

STEEL BRUSH



- Maximum width steel brush 8,5mm
- Maximum width plastic holder 12,5mm
- Length brush 90mm
- Also available in display with 12-pcs



ART. NO.	L(MM)	G	PCS/BAG
4811254	225	65	10

BRASS BRUSH



Applicable on all aluminium brake callipers to remove brake dust
Also suitable for cleaning work on all metallic surfaces

ART. NO.	L(MM)	G	PCS/BAG
4811260	235	58	10

DIGITAL VERNIER CALIPER



ART. NO.	L(MM)	G	PCS/BAG
47010	235	158	10

FEELER GAUGE 26-PCS

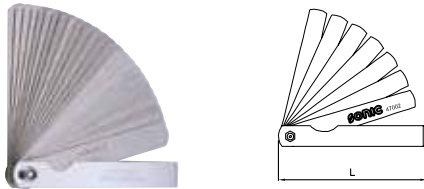

ART. NO.	L(MM)	G	PCS/BAG
47002	92	86	10

FEELER GAUGE 20-PCS

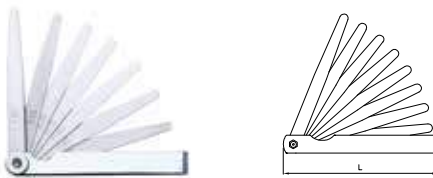

ART. NO.	L(MM)	G	PCS/BAG
47006	108	92	10

STAINLESS STEEL STRAIGHT RULER (30CM)



ART. NO.	L(MM)	G	PCS/BAG
47004	330	50	10

STAINLESS SQUARE RULER 200X125MM



ART. NO.	L(MM)	G	PCS/BAG
47032	200	60	10

STAINLESS STEEL PROTRACTOR



ART. NO.	L(MM)	G	PCS/BAG
47005	200	64	10

STAINLESS STEEL VERNIER CALIPER



ART. NO.	L(MM)	G	PCS/BAG
47003	230	150	6

STAINLESS STEEL VERNIER CALIPER



ART. NO.	L(MM)	G	PCS/BAG
47008	230	132	10

STAINLESS STEEL VERNIER CALIPER FOR DISC BRAKES



ART. NO.	L1(MM)	L2(MM)	L(MM)	G	PCS/BAG
47024	175	50	54	226	1

TYRE PROFILE GAUGE



ART. NO.	L(MM)	W(MM)	G	PCS/BAG
47028	90	55	38	10

MEASURING TAPE 5M



Special designed stop button, offers more comfort and anti-fatigue

ART. NO.	L(MM)	G	PCS/BAG
47013	81	112	10

MEASURING TAPE 15 METER



Measuring tape 15m with accuracy class III, meets the requirements for APK-2.

ART. NO.	G	PCS/BAG
4822505	408	1

Sonic pliers, hammers, chisels, files, measuring and cutting tools

DOOR UPHOLSTERY PANEL REMOVER



ART. NO.	L1(MM)	L2(MM)	L(MM)	G	PCS/BAG
47901	100	115	215	106	10

SEAL SCRAPER



ART. NO.	L1(MM)	L2(MM)	L(MM)	G	PCS/BAG
47819	280	75	30	156	10

DOOR UPHOLSTERY PANEL REMOVER



ART. NO.	L1(MM)	L2(MM)	L(MM)	G	PCS/BAG
47902	110	124	234	169	10

ANGLE SCRAPER



ART. NO.	L1(MM)	L2(MM)	L(MM)	G	PCS/BAG
47820	265	30	30	158	10

SCRAPER



ART. NO.	L1(MM)	L2(MM)	L(MM)	G	PCS/BAG
47903	125	124	249	155	10

COTTER PIN PULLER



ART. NO.	L1(MM)	L2(MM)	L(MM)	G	PCS/BAG
47904	125	115	240	116	10

PLASTIC SCRAPER



ART. NO.	L1(MM)	L2(MM)	L(MM)	G	PCS/BAG
47817	260	37	37	82	1

RADIATOR HOSE REMOVER



ART. NO.	L1(MM)	L2(MM)	L(MM)	G	PCS/BAG
47905	80	115	195	106	10

14

TRIM REMOVAL



ART. NO.	L1(MM)	L2(MM)	L(MM)	G	PCS/BAG
47825	190	30	12.5	28	1

TRIM PAD TOOL



ART. NO.	L1(MM)	L2(MM)	L(MM)	G	PCS/BAG
47906	115	115	230	110	10

STICKER SCRAPER



ART. NO.	L1(MM)	L2(MM)	L(MM)	G	PCS/BAG
47818	280	30	30	152	10

TRIM PAD TOOL



ART. NO.	L1(MM)	L2(MM)	L(MM)	G	PCS/BAG
47907	115	124	239	134	10

DOOR UPHOLSTERY PANEL REMOVER



ART. NO.	L1[MM]	L2[MM]	L[MM]	G	PCS/BAG
47908	132	124	256	183	10

MINI STRAIGHT PICK HOOK



ART. NO.	L1[MM]	L2[MM]	L[MM]	G	PCS/BAG
47829	70	92	162	30	10

STRAIGHT PICK HOOK



ART. NO.	L1[MM]	L2[MM]	L[MM]	G	PCS/BAG
47909	135	115	250	108	10

MINI DEGREE HOOK



ART. NO.	L1[MM]	L2[MM]	L[MM]	G	PCS/BAG
47830	70	92	162	30	10

DEGREE HOOK



ART. NO.	L1[MM]	L2[MM]	L[MM]	G	PCS/BAG
47910	135	115	250	112	10

MINI FULL HOOK



ART. NO.	L1[MM]	L2[MM]	L[MM]	G	PCS/BAG
47831	70	92	162	30	10

FULL HOOK



ART. NO.	L1[MM]	L2[MM]	L[MM]	G	PCS/BAG
47911	135	115	250	112	10

MINI SMALL ANGLE HOOK



ART. NO.	L1[MM]	L2[MM]	L[MM]	G	PCS/BAG
47832	70	92	162	30	10

FULL HOOK



ART. NO.	L1[MM]	L2[MM]	L[MM]	G	PCS/BAG
47912	135	115	250	110	10

MAGNET PICKUP



ART. NO.	L1[MM]	L3[MM]	L2[MM]	L[MM]	G	PCS/BAG
4820201	90	465	70	160-535	35	10

HOOK FOR EXHAUST RUBBER RINGS



ART. NO.	L[MM]	G	PCS/BAG
47814	235	100	48

Sonic pliers, hammers, chisels, files, measuring and cutting tools

MAGNET PICKUP (4,5KG)



ART. NO.	L1(MM)	L3(MM)	L2(MM)	L(MM)	G	PCS/BAG
4820110	75	650	120	195-770	58	5

EXTENDABLE MAGNET PICKUP (2,8 KG)



Also available in display with 16 pcs



ART. NO.	L1(MM)	L3(MM)	L2(MM)	L(MM)	G	PCS/BAG
4820106	30	490	130	160-620	60	16

FLEXIBLE MAGNET PICKUP 500GR



ART. NO.	L1(MM)	L2(MM)	L(MM)	G	PCS/BAG
4820207	300	115	415	120	5

TELESCOPIC MIRROR 30-74CM



ART. NO.	L(MM)	G	PCS/BAG
4820111	318-618	76	10

PRY BAR



ART. NO.	L1(MM)	L2(MM)	L(MM)	G	PCS/BAG
4821308	90	115	205	108	5
4821312	180	125	305	254	5
4821318	330	125	455	456	5
4821324	435	125	560	596	5

BENT PRY BAR 8"



ART. NO.	L1(MM)	L2(MM)	L(MM)	G	PCS/BAG
48203210	88	121	209	146	10

BENT FORKED PRY BAR 12"



ART. NO.	L1(MM)	L2(MM)	L(MM)	G	PCS/BAG
48203300	192	121	313	284	10

ELBOW BENT PRY BAR 18"



ART. NO.	L1(MM)	L2(MM)	L(MM)	G	PCS/BAG
48203460	325	144	469	538	5

EXTENDED PRY BAR 24"



ART. NO.	L1(MM)	L2(MM)	L(MM)	G	PCS/BAG
48203610	466	144	610	682	5

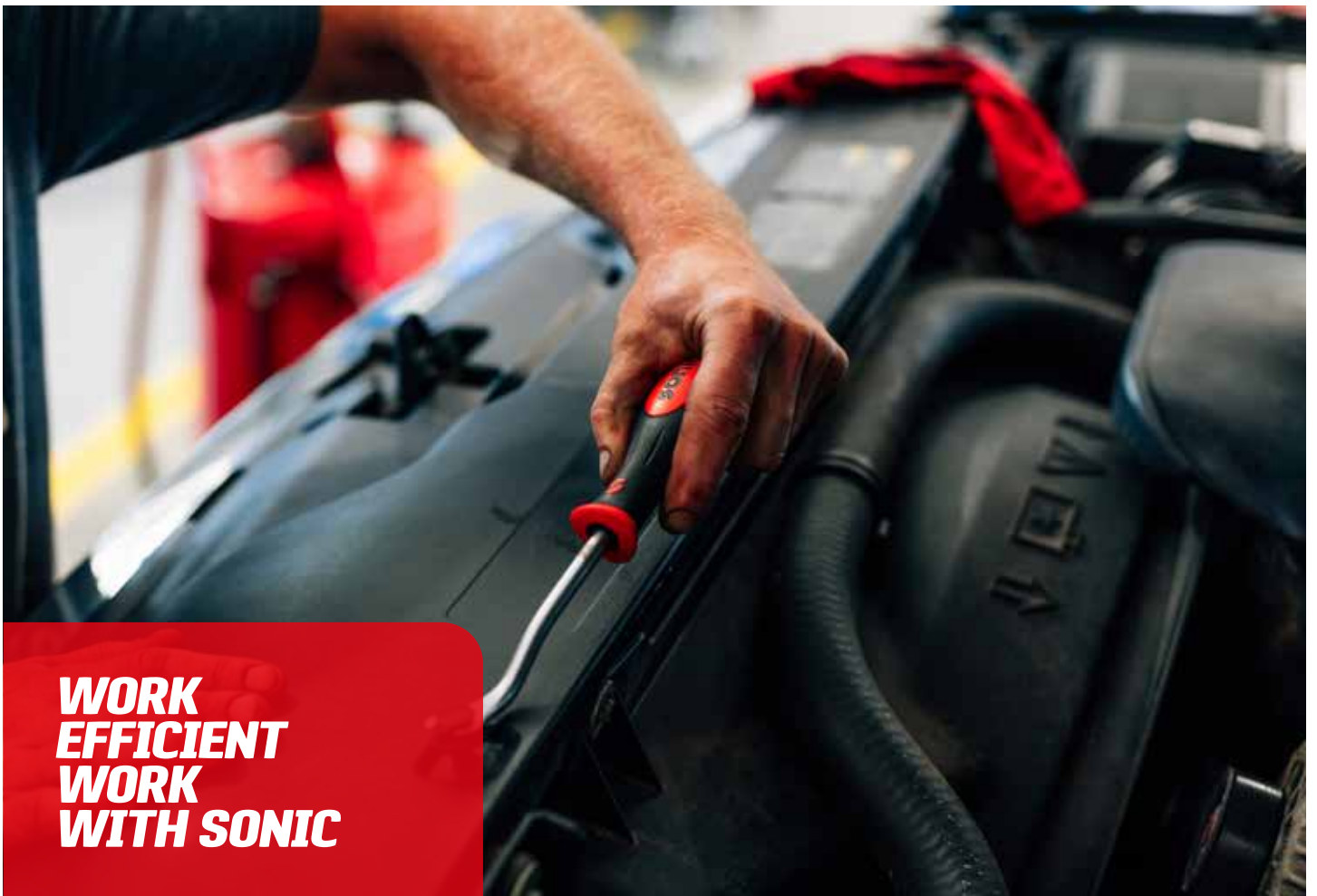

**WORK
EFFICIENT
WORK
WITH SONIC**

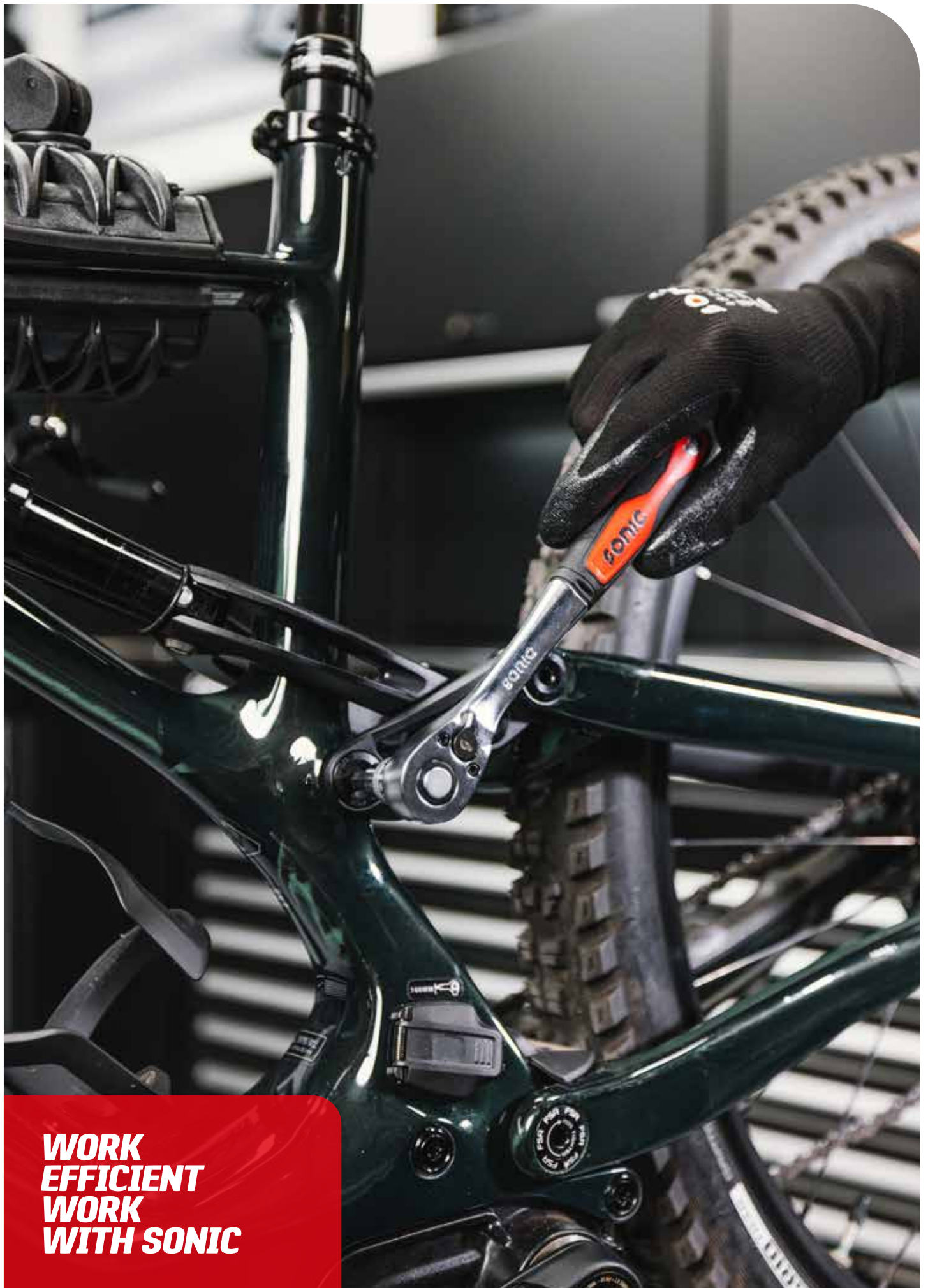

15

**WORK
EFFICIENT
WORK
WITH SONIC**



SONIC RATCHETS

Designed to optimize
comfort & torque.

15 > Ratchets



> Ratchets 1/4"
PAGE 375-377



> Ratchets 3/8"
PAGE 375-377



> Ratchets 1/2"
PAGE 375-377



> Ratchets 3/4"
PAGE 377



> Ratchet 1"
PAGE 377



> Repair sets ratchets
PAGE 375-378



> Swivle handle
PAGE 378



> Spinner
PAGE 378



> T-handles
PAGE 379



> Extensions
PAGE 379



> Extensions impact
PAGE 380



> Universal joints
PAGE 380



> Universal impact joints
PAGE 380



> Adaptors
PAGE 381



> Impact adaptors
PAGE 381



> Bit holders
PAGE 381



> Impact bit holders
PAGE 382



> Insert holder for bits
PAGE 382



> Magnet socket
PAGE 382

RATCHET - 52 TEETH

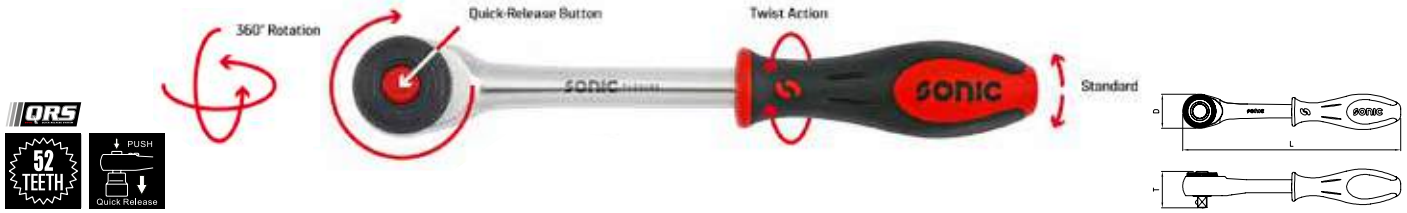

ART. NO.	SIZE	L[MM]	T[MM]	D[MM]	G	PCS/BAG
7121101	1/4"	165	33.71	33.71	182	10
7121102	3/8"	232	38.77	38.77	430	10
7121103	1/2"	277	44.8	44.8	678	10

RATCHET - 60 TEETH



ART. NO.	SIZE	L[MM]	T[MM]	D[MM]	G	PCS/BAG
7121501	1/4"	147	20	21	90	10
7121502	3/8"	195	28	28	214	10
7121503	1/2"	260	35	37	492	5

REPAIR SET



ART. NO.	DESCRIPTION	PCS/BAG
7121501P	Repair set 7121501	1
7121502P	Repair set 7121502	1
7121503P	Repair set 7121503	1

RATCHET - 45 TEETH



ART. NO.	SIZE	L[MM]	T[MM]	D[MM]	G	PCS/BAG
7120901	1/4"	140	23	26	122	10
7120902	3/8"	195	30	33	298	10
7120903	1/2"	255	37	43	590	5

REPAIR SET



ART. NO.	DESCRIPTION	PCS/BAG
7120901P	Repair set ratchet 7120101 & 7120901	1
7120902P	Repair set ratchet 7120102 & 7120902	1
7120903P	Repair set ratchet 7120903	1

RATCHET - 72 TEETH

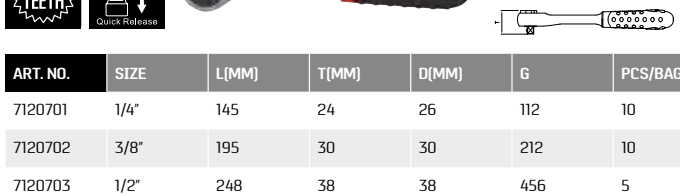

ART. NO.	SIZE	L[MM]	T[MM]	D[MM]	G	PCS/BAG
7120701	1/4"	145	24	26	112	10
7120702	3/8"	195	30	30	212	10
7120703	1/2"	248	38	38	456	5

REPAIR SET

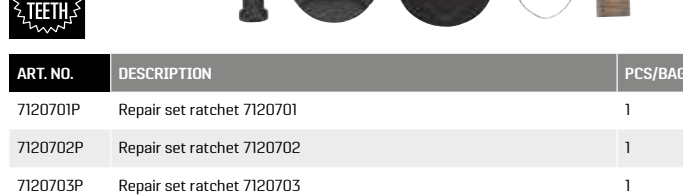

ART. NO.	DESCRIPTION	PCS/BAG
7120701P	Repair set ratchet 7120701	1
7120702P	Repair set ratchet 7120702	1
7120703P	Repair set ratchet 7120703	1

STUBBY RATCHET - 45 TEETH

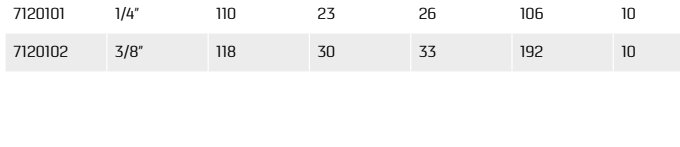

ART. NO.	SIZE	L[MM]	T[MM]	D[MM]	G	PCS/BAG
7120101	1/4"	110	23	26	106	10
7120102	3/8"	118	30	33	192	10

REPAIR SET

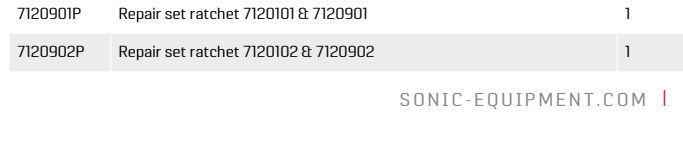

ART. NO.	DESCRIPTION	PCS/BAG
7120901P	Repair set ratchet 7120101 & 7120901	1
7120902P	Repair set ratchet 7120102 & 7120902	1

Sonic ratchets

FLEXIBLE RATCHET - 45 TEETH



QRS

45 TEETH

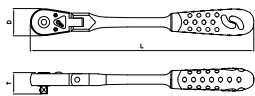

ART. NO.	SIZE	L(MM)	T(MM)	D(MM)	G	PCS/BAG
7110101	1/4"	133	23	26	142	10
7110102	3/8"	265	30	33	418	10
711013300	1/2"	300	37	43	724	5
711013440	1/2"	440	37	43	932	5

REPAIR SET

45 TEETH



ART. NO.	DESCRIPTION	PCS/BAG
7110101P	Repair set ratchet 7110101	1
7110102P	Repair set ratchet 7110102	1
711013P	Repair set ratchet 711013300 & 711013440	1

FLEXIBLE RATCHET WITH LOCK FUNCTION - 45 TEETH



QRS

45 TEETH

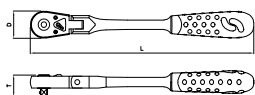

ART. NO.	SIZE	L(MM)	T(MM)	D(MM)	G	PCS/BAG
7110801	1/4"	133	26	26	410	10
7110802	3/8"	265	30	33	410	10
7110803	1/2"	300	40	43	410	10

ROTOR HEAD RATCHET - 72 TEETH



QRS

72 TEETH

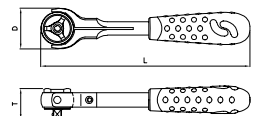

ART. NO.	SIZE	L(MM)	T(MM)	D(MM)	G	PCS/BAG
7110201	1/4"	150	24	32	130	10
7110202	3/8"	235	34	44	385	10
7110203	1/2"	305	40	49	652	10

REPAIR SET

72 TEETH



ART. NO.	DESCRIPTION	PCS/BAG
7110201P	Repair set ratchet 7110201	1
7110202P	Repair set ratchet 7110202 & 7110402	1
7110203P	Repair set ratchet 7110203 & 7110403	1

ROTOR HEAD STUBBY RATCHET - 72 TEETH



QRS

72 TEETH

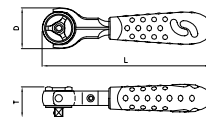

ART. NO.	SIZE	L(MM)	T(MM)	D(MM)	G	PCS/BAG
7110402	3/8"	155	34	44	278	10
7110403	1/2"	182	40	49	472	10

REPAIR SET

72 TEETH



ART. NO.	DESCRIPTION	PCS/BAG
7110202P	Repair set ratchet 7110202 & 7110402	1
7110203P	Repair set ratchet 7110203 & 7110403	1

EXTENDABLE RATCHET - 72 TEETH



QRS

72 TEETH

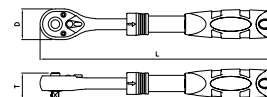

ART. NO.	SIZE	L(MM)	T(MM)	D(MM)	G	PCS/BAG
7120301	1/4"	150-200	23	25	172	5
7120302	3/8"	215-315	33	32	436	5
7120303	1/2"	305-445	40	40	918	5

REPAIR SET

72 TEETH



ART. NO.	DESCRIPTION	PCS/BAG
7120301P	Repair set ratchet 7120301	1
7120302P	Repair set ratchet 7120302	1
7120303P	Repair set ratchet 7120303	1

300313 - DISC RATCHET 3-PCS - 72 TEETH



DISC RATCHET - 72 TEETH



ART. NO.	SIZE	T(MM)	D(MM)	G	PCS/BAG
7110301	1/4"	25	49	50	10
7110302	3/8"	28	49	58	10
7110303	1/2"	32	49	64	10

REPAIR SET



ART. NO.	DESCRIPTION	PCS/BAG
7110301P	Repair set ratchet 7110301	1
7110302P	Repair set ratchet 7110302	1

RATCHET - 60 TEETH

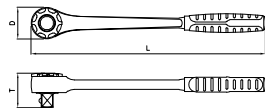

ART. NO.	SIZE	L(MM)	T(MM)	D(MM)	G	PCS/BAG
7120704	3/4"	505	64	68	1934	1

EXTENDABLE RATCHET - 36 TEETH

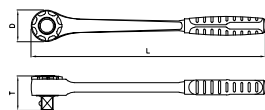
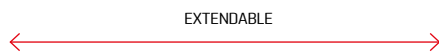

ART. NO.	SIZE	L(MM)	T(MM)	D(MM)	G	PCS/BAG
7121403	1/2"	355-510	46	42	1060	5

REPAIR SET



ART. NO.	DESCRIPTION	PCS/BAG
7120704P	Repair set ratchet 7120704	1

RATCHET - 24 TEETH

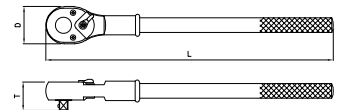

ART. NO.	SIZE	L(MM)	T(MM)	D(MM)	G	PCS/BAG
7121204	3/4"	500	55	64	2608	2
7121305	1"	660	67	72	4390	1

RATCHET - 24 TEETH

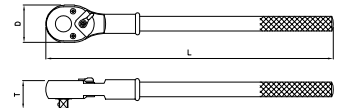

ART. NO.	SIZE	L(MM)	T(MM)	D(MM)	G	PCS/BAG
7121205	1"	500	64	55	2618	2

REPAIR SET



ART. NO.	DESCRIPTION	PCS/BAG
7121204P	Repair set ratchet 7121204	1
7121205P	Repair set ratchet 7121205	1

Sonic ratchets

SWIVEL HANDLE

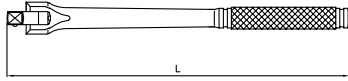

ART. NO.	SIZE	L(MM)	G	PCS/BAG
7232200	3/8"	200	280	10
7232250	3/8"	250	342	5
7233250	1/2"	250	490	5
7233380	1/2"	380	782	2
7234500	3/4"	500	1804	1
7234600	3/4"	630	2178	1

SWIVEL GRIP HANDLE



ART. NO.	SIZE	L(MM)	G	PCS/BAG
7271150	1/4"	155	98	10
7272200	3/8"	220	262	10
7272250	3/8"	250	294	5
7273250	1/2"	270	490	5
7273380	1/2"	370	650	2

REPAIR SET



ART. NO.	DESCRIPTION	PCS/BAG
7271P	Repair set Swivel handle 7271150	1
7232P	7232200, 7232250, 7272200 & 7272250	1
7233P	7233250, 7233380, 7273250 & 7273380	1

SWIVEL HANDLE 24"

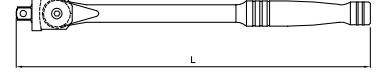

ART. NO.	SIZE	L(MM)	G	PCS/BAG
7233600	1/2"	635	1386	1

REPAIR SET



ART. NO.	DESCRIPTION	PCS/BAG
7233601	Repair set swivel handle 7233600	1

SWIVEL RATCHET HANDLE 24"



ART. NO.	SIZE	L(MM)	G	PCS/BAG
7233605	1/2"	605	1580	1

RATCHET - 45 TEETH



ART. NO.	SIZE	L(MM)	G	PCS/BAG
7233602	1/2"	665	370	1

SPINNER - 150 MML



ART. NO.	SIZE	L(MM)	T(MM)	D(MM)	G	PCS/BAG
72401	1/4"	65	85	150	85	10

SPINNER - 150 MML



ART. NO.	SIZE	L(MM)	T(MM)	D(MM)	G	PCS/BAG
72402	1/4"	65	85	150	85	10

LONG FLEXIBLE SPINNER



ART. NO.	SIZE	L(MM)	G	PCS/BAG
72403	1/4"	555	85	10

SLIDING T-HANDLE UNIVERSAL JOINT

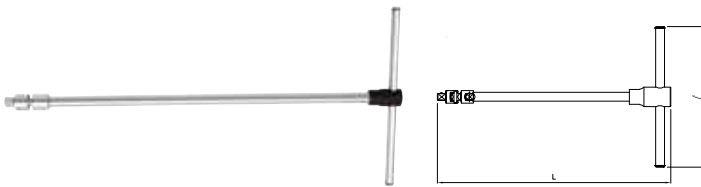

ART. NO.	SIZE	L(MM)	L(MM)	G	PCS/BAG
7152450	3/8"	450	200	452	10

SPEEDY T-GRIP

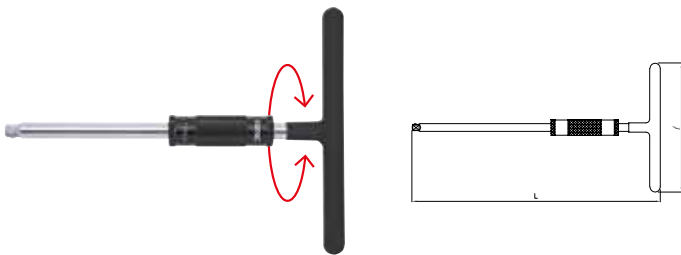

ART. NO.	SIZE	L(MM)	L(MM)	G	PCS/BAG
72601	1/4"	322	140	320	5
72602	3/8"	326	181	550	5
72603	1/2"	330	242	1088	5

SLIDING T-HANDLE



ART. NO.	SIZE	L(MM)	G	PCS/BAG
7131115	1/4"	115	45	10
7132165	3/8"	165	150	10
7133250	1/2"	250	345	5
7134450	3/4"	450	1370	2
7135560	1"	560	3292	2

SLIDING T-HANDLE



ART. NO.	SIZE	L(MM)	G	PCS/BAG
7135550	1"	560	2656	2

EXTENSION

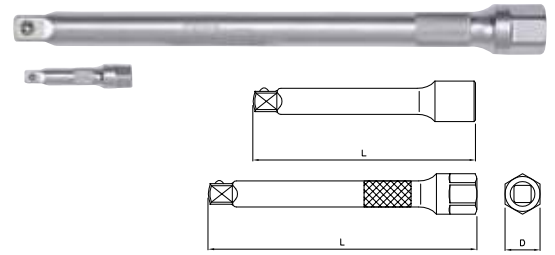

ART. NO.	SIZE	L(MM)	D(MM)	G	PCS/BAG
7141050	1/4"	50	11	22	10
7141100	1/4"	100	11	42	10
7141150	1/4"	150	11	64	10
7141250	1/4"	250	12	106	10
7142044	3/8"	44	16	36	10
7142075	3/8"	75	16	70	10
7142150	3/8"	150	16	140	10
7142200	3/8"	200	16	200	10
7142250	3/8"	250	16	230	10
7142300	3/8"	300	16	295	10
7142450	3/8"	450	16	400	10
7142600	3/8"	600	16	550	10
7143125	1/2"	125	22	216	10
7143250	1/2"	250	22	416	5
7144100	3/4"	100	35.8	402	2
7144200	3/4"	200	35.8	738	2
7145200	1"	200	48.0	1302	2
7145400	1"	410	48.0	2264	2

WOBBLE EXTENSION

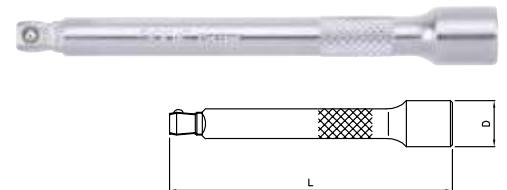

ART. NO.	SIZE	L(MM)	D(MM)	G	PCS/BAG
7261050	1/4"	50	12,3	24	10
7261100	1/4"	100	12,3	44	10
7261250	1/4"	250	12,3	106	10
7262044	3/8"	44	16	40	10
7262075	3/8"	75	16	65	10
7262150	3/8"	150	16	140	10
7262200	3/8"	200	16	192	10
7262250	3/8"	250	16	140	10
7262300	3/8"	300	16	295	10
7262450	3/8"	450	16	400	10
7263050	1/2"	50	24	95	10
7263125	1/2"	125	24	200	10
7263250	1/2"	250	24	430	5
7263500	1/2"	500	24	840	1

Sonic ratchets

LOCK-IN EXTENSION

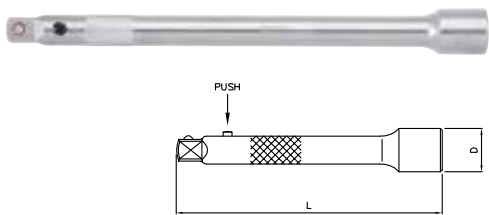

ART. NO.	SIZE	L(MM)	D(MM)	G	PCS/BAG
7183075	1/2"	75	23.8	128	10
7183125	1/2"	125	23.8	206	10
7183250	1/2"	250	23.8	410	10

IMPACT EXTENSION



ART. NO.	SIZE	L(MM)	D(MM)	G	PCS/BAG
7344150	3/4"	150	40.0	700	1
7344250	3/4"	250	40.0	1060	1
7344400	3/4"	400	40.0	1600	1

LOCK-IN EXTENSION

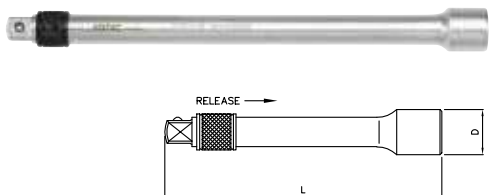

ART. NO.	SIZE	L(MM)	D(MM)	G	PCS/BAG
7184400	3/4"	400	36	1556	1

IMPACT EXTENSION



ART. NO.	SIZE	L(MM)	D(MM)	G	PCS/BAG
7345150	1"	150	52	1170	1
7345175	1"	175	52	1390	1
7345250	1"	250	52	1880	1
7345400	1"	400	52	2870	1

FLEXIBLE EXTENSION

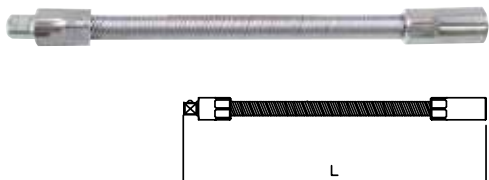

ART. NO.	SIZE	L(MM)	G	PCS/BAG
7211	1/4"	145	55	10

UNIVERSAL JOINT

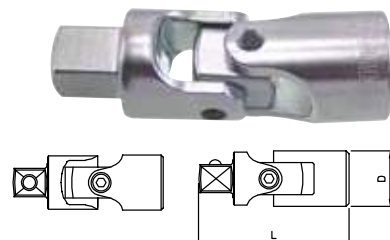

ART. NO.	SIZE	L(MM)	D(MM)	G	PCS/BAG
71511	1/4"	37	13.8	24	10
71521	3/8"	52	18.7	60	10
71531	1/2"	70	24.6	138	10

IMPACT EXTENSION



ART. NO.	SIZE	L(MM)	D(MM)	G	PCS/BAG
7342075	3/8"	75	19	80	10
7343075	1/2"	75	25	146	10
7343125	1/2"	125	25	226	5
7343250	1/2"	250	25	432	5

REPAIR SET



ART. NO.	DESCRIPTION	PCS/BAG
71511P	Repair set universal joint 71511	1
71521P	Repair set universal joint 71521	1
71531P	Repair set universal joint 71531	1

IMPACT UNIVERSAL JOINT

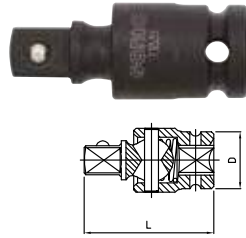

ART. NO.	SIZE	L(MM)	D(MM)	G	PCS/BAG
73521	3/8"	46	24	78	10
73531	1/2"	60	28	142	10
73541	3/4"	94	42	500	1

IMPACT ADAPTOR



ART. NO.	SIZE	L(MM)	D(MM)	G	PCS/BAG
73645	3/4"(F)x1"(M)	63	44	440	1

ADAPTOR



ART. NO.	SIZE	L(MM)	D(MM)	G	PCS/BAG
71912	1/4"(F)x3/8"(M)	26	12	18	10
71921	3/8"(F)x1/4"(M)	27	17	20	10
71923	3/8"(F)x1/2"(M)	36	18	45	10
71932	1/2"(F)x3/8"(M)	36	22	48	10
71934	1/2"(F)x3/4"(M)	46	26	124	10
71943	3/4"(F)x1/2"(M)	51	31,5	134	10

ADAPTOR



ART. NO.	SIZE	L(MM)	D(MM)	G	PCS/BAG
71623	3/8"(F)x1/2"(M)	43	23,8	68	10
71632	1/2"(F)x3/8"(M)	39	23,8	66	10
7135	1"	80	49	632	2

IMPACT ADAPTOR



ART. NO.	SIZE	L(MM)	D(MM)	G	PCS/BAG
73612	1/4"(F)x3/8"(M)	26	14	20	10
73621	3/8"(F)x1/4"(M)	32	22	46	10
73623	3/8"(F)x1/2"(M)	36	22	68	10
73632	1/2"(F)x3/8"(M)	38	25	68	10
73634	1/2"(F)x3/4"(M)	48	30	160	10
73643	3/4"(F)x1/2"(M)	56	44	320	10

BIT HOLDER

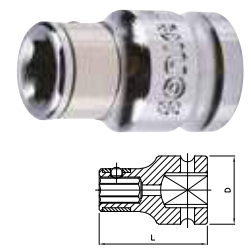

ART. NO.	SIZE	L(MM)	D(MM)	G	PCS/BAG
72011	1/4"(F) X 1/4"(F)	25	12	12	10
72023	3/8"(F) x 10mm(F)	29	17	28	10
72032	1/2"(F) x 5/16(F)	38	22	44	10
72033	1/2"(F) x 10mm(F)	38	22	52	10

Sonic ratchets

IMPACT BIT HOLDER

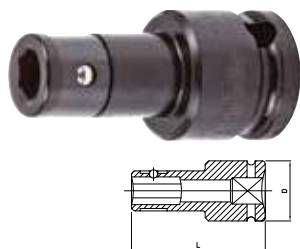

ART. NO.	SIZE	L(MM)	D(MM)	G	PCS/BAG
73721	3/8"(F)x1/4"(F)	40	19	36	10

MAGNET SOCKET PICK-UP 1/4"

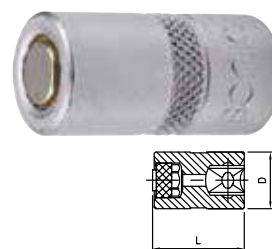

ART. NO.	SIZE	L(MM)	D(MM)	G	PCS/BAG
72225	1/4"	25	12	16	10

INSERT HOLDER FOR BITS 9X12



ART. NO.	SIZE	L(MM)	G	PCS/BAG
7201001	1/4"	42.5	52	10
7202001	5/6"	42.5	52	10



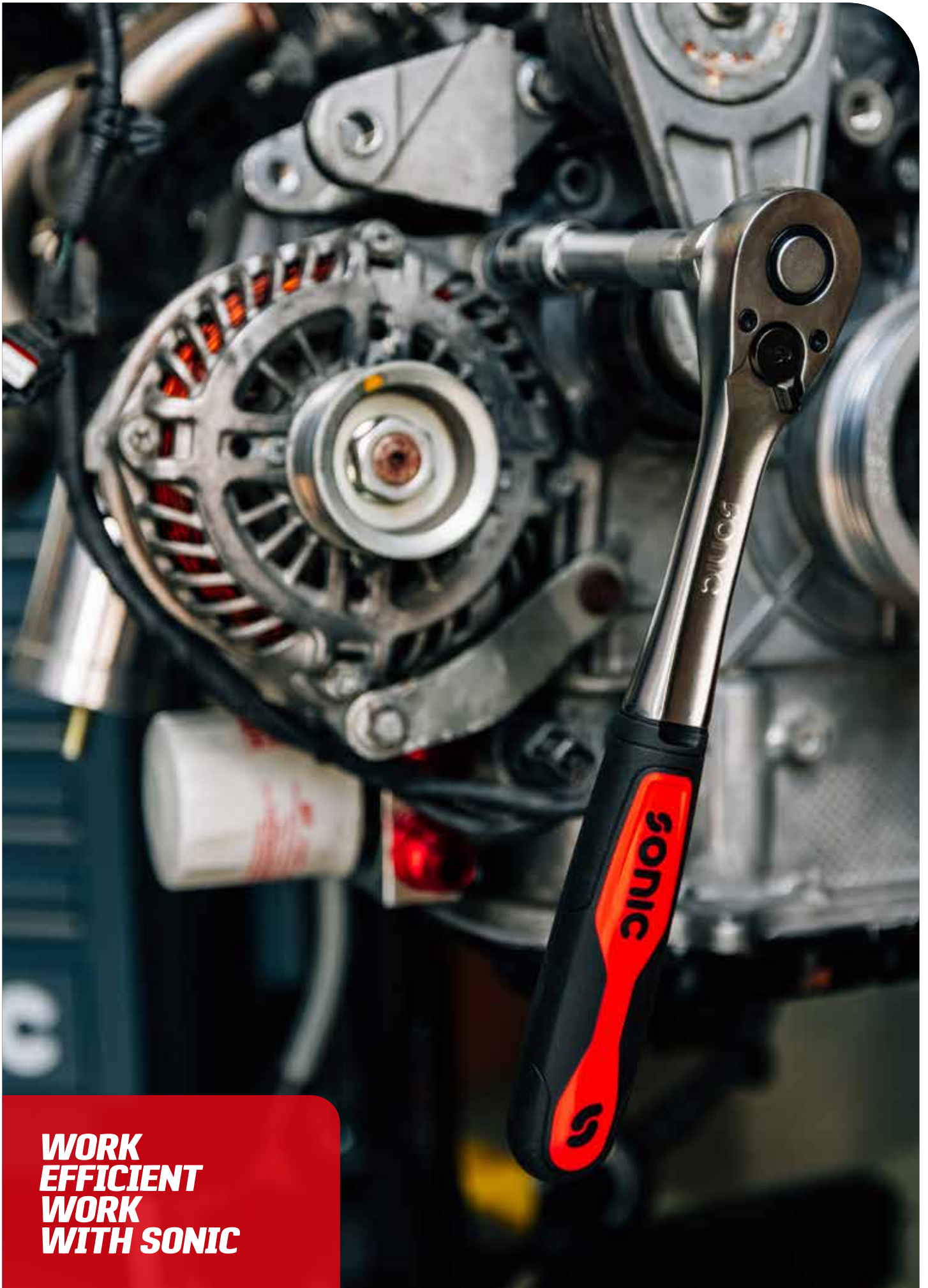

**WORK
EFFICIENT
WORK
WITH SONIC**



**WORK
EFFICIENT
WORK
WITH SONIC**



SONIC TORQUE WRENCHES

Accuracy at its finest.

16 > Sonic torque wrenches



> Torque wrenches
PAGE 387



> Repair set torque wrenches
PAGE 387



> Torque wrench sets
PAGE 388

Sonic offers torque wrenches with two types of connections:
The fixed connection and the push-through square (left and right turning).
Offers a total range from 1/4" to 1" jack, ranging from 5Nm to 1000Nm.

TORQUE WRENCH

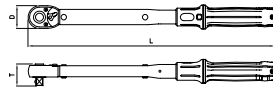
QRS
45 TEETH

ART. NO.	SIZE	NM	D(MM)	T(MM)	L(MM)	G
73210525	1/4"	5-25	26	22	290	405
73220550	3/8"	10-50	40.5	37	360	920
732210100	3/8"	20-100	40.5	37	405	1020
732310100	1/2"	20-100	40.5	40	405	1020
732320200	1/2"	40-200	40.5	40	500	1220
732360300	1/2"	60-300	40.5	40	595	1330
732380400	1/2"	80-400	40.5	40	680	1820
7324550	3/4"	110-550	63.0	58	970	3700
7324750	3/4"	150-750	63.0	58	1150	5600
73241000	3/4"	200-1000	63.0	63	1250	7200
7325750	1"	150-750	63.0	58	1150	5600
73251000	1"	200-1000	63.0	63	1250	7200

REPAIR SET
45 TEETH

ART. NO.	DESCRIPTION	PCS/BAG
73210525P	Repair set torque wrench 73210525	1
7322P	Repair set torque wrench 73220550 & 732210100	1
7323P	Repair set torque wrench 732310100, 732320200, 732360300 & 732380400	1
7324550P	Repair set torque wrench 7324550	1
7324750P	Repair set torque wrench 7324750 & 73241000	1
7325P	Repair set torque wrench 7325750 & 73251000	1

TORQUE WRENCH

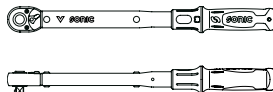
45 TEETH
24 TEETH

ART. NO.	SIZE	NM	D(MM)	T(MM)	L(MM)	G
73021050	3/8"	10-50	40.5	37	360	920
730220100	3/8"	20-100	40.5	37	405	1020
730320100	1/2"	20-100	40.5	40	405	1020
730340200	1/2"	40-200	40.5	40	500	1220
730360300	1/2"	60-300	40.5	40	595	1330
730380400	1/2"	80-400	40.5	40	680	1820
7304110550	3/4"	110-550	63.0	58	970	3700
7304150750	3/4"	150-750	63.0	58	1150	5600

REPAIR SET
45 TEETH
24 TEETH

ART. NO.	DESCRIPTION	PCS/BAG
7302P	Repair set torque wrench 73021050 & 730220100	1
7303P	Repair set torque wrench 730320100, 730340200, 730360300 & 730380400	1
7304P	Repair set torque wrench 7304110550 & 7304150750	1

Sonic torque wrenches

600907 - TORQUE WRENCH SET EXCHANGEABLE HEAD 9X12 RING-OPEN 4-20NM, 8-PCS



72 TEETH
6.3
1/4"
GG0

This tool allows the usual 1/4" Torque operation but with the added innovation of changing the ratchet head to a Spanner head for tightening bolts to a specific torque.

9x12 torque wrench 4-20nm

9x12 open ended insert tool 13, 17, 19 mm

9x12 ring insert tool 13, 17, 19 mm

9x12 72 teeth ratchet insert tool 1/4"

601105 - TORQUE WRENCH EXCHANGEABLE HEAD 14X18 RING HEAD 60-340NM, 11-PCS



72 TEETH
12.5
1/2"
GG0

This tool allows the usual 1/2" Torque operation but with the added innovation of changing the ratchet head to a Spanner head for tightening bolts to a specific torque.

ART. NO.	DESCRIPTION	PCS/BAG
73114340	14x18 torque wrench 68-340nm	1
7311403	14x18, 1/2"DR. Ratchet head (72th)	1
73114213...30	14x18, Ring end insert 13, 14, 15, 17, 19, 22, 24, 27, 30mm	9

600908 - TORQUE WRENCH SET EXCHANGEABLE HEAD 9X12 RING-OPEN 10-60NM, 8-PCS



72 TEETH
10
3/8"
GG0

This tool allows the usual 3/8" Torque operation but with the added innovation of changing the ratchet head to a Spanner head for tightening bolts to a specific torque.

9x12 torque wrench 12-60nm

9x12 open ended insert tool 13, 17, 19mm

9x12 ring insert tool 13, 17, 19mm

9x12 72 teeth ratchet insert tool 3/8"

601106 - TORQUE WRENCH EXCHANGEABLE HEAD 14X18 OPEN HEAD 60-340NM, 11-PCS



72 TEETH
12.5
1/2"
GG0

This tool allows the usual 1/2" Torque operation but with the added innovation of changing the ratchet head to a Spanner head for tightening bolts to a specific torque.

ART. NO.	DESCRIPTION	PCS/BAG
73114340	14x18 Torques wrench 60-340Nm	1
7311403	14x18, 1/2"DR. Ratchet head (72th)	1
73114113...30	14x18, Ring end insert 13, 14, 15, 17, 19, 22, 24, 27, 30mm	9

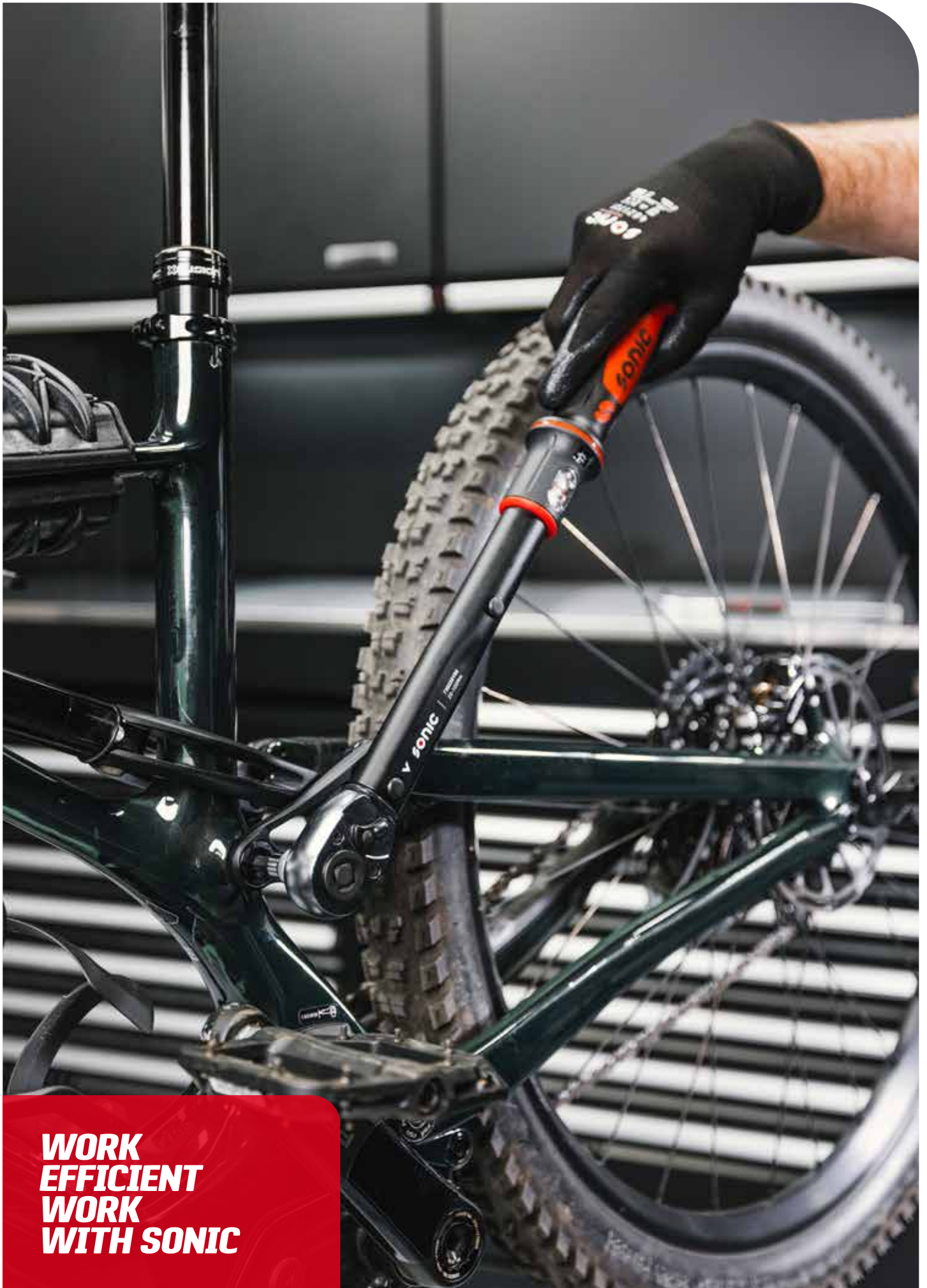

**WORK
EFFICIENT
WORK
WITH SONIC**

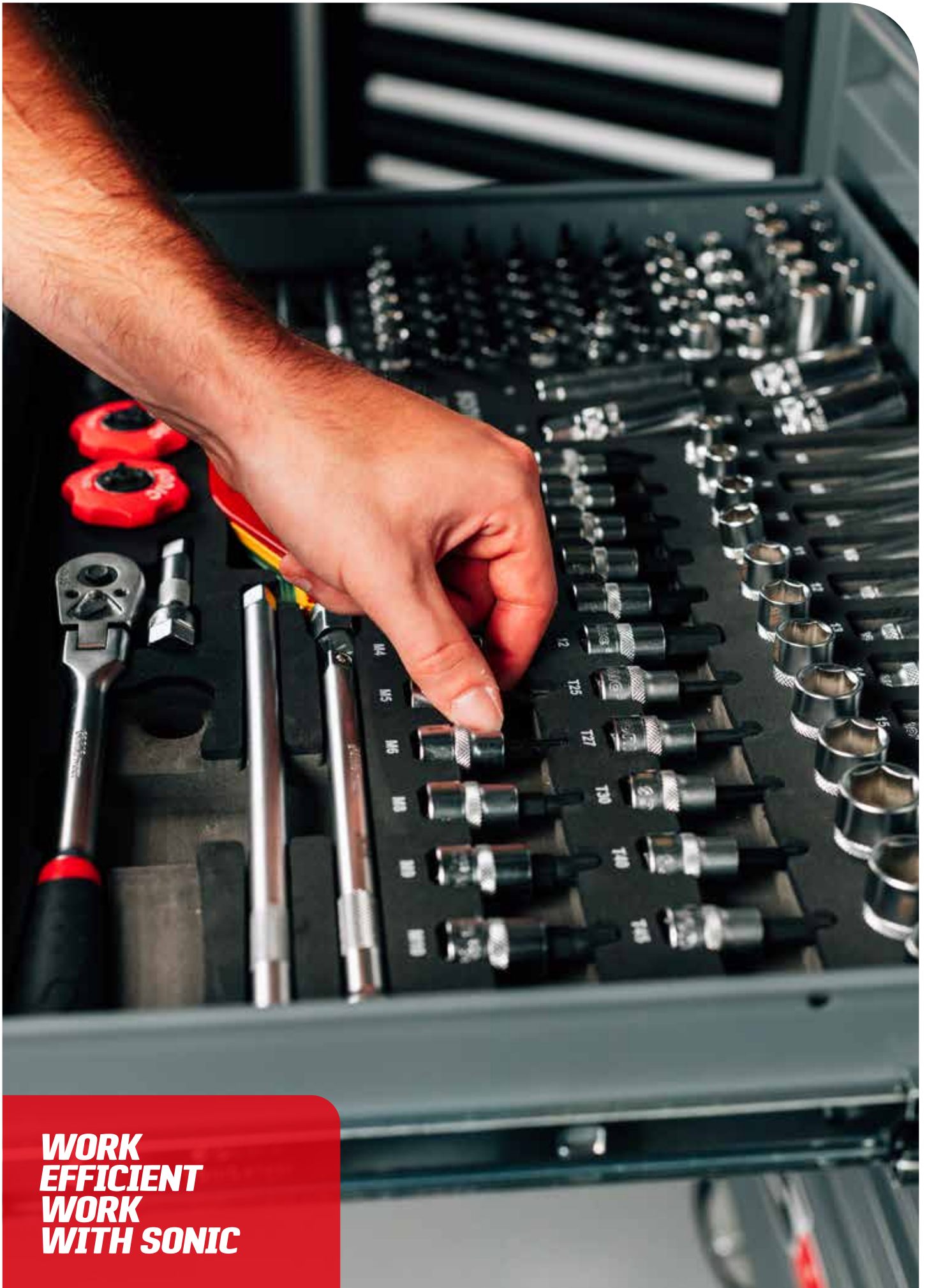

**WORK
EFFICIENT
WORK
WITH SONIC**



SONIC BIT SOCKETS

Sturdy, slim & compact.

17 > Sonic Bit sockets

-  > Bit sockets 1/4", PH
PAGE 393
-  > Bit sockets 1/4", PZ
PAGE 393
-  > Bit sockets 1/4", slotted
PAGE 393
-  > Bit sockets 1/4", hex
PAGE 393
-  > Bit sockets 1/4", hex SAE
PAGE 393
-  > Bit sockets 1/4", TX
PAGE 393
-  > Bit sockets 1/4", TX tamperproof
PAGE 394
-  > Bit sockets 1/4", TX plus
PAGE 394
-  > Bit sockets 1/4", spline
PAGE 394
-  > Bit sockets 1/4", ribe
PAGE 394
-  > Bit sockets 3/8", PH
PAGE 394
-  > Bit sockets 3/8", PZ
PAGE 394
-  > Bit sockets 3/8", slotted
PAGE 395
-  > Bit sockets 3/8", hex
PAGE 395
-  > Bit sockets 3/8", hex SAE
PAGE 395
-  > Bit sockets 3/8", TX
PAGE 395
-  > Bit sockets 3/8", TX tamperproof
PAGE 396
-  > Bit sockets 3/8", spline
PAGE 396
-  > Bit sockets 3/8", ribe
PAGE 396
-  > Bit sockets 1/2", hex
PAGE 397
-  > Bit sockets 1/2", hex SAE
PAGE 398
-  > Bit sockets 1/2", TX
PAGE 398
-  > Bit sockets 1/2", TX tamperproof
PAGE 398
-  > Bit sockets 1/2", spline
PAGE 399
-  > Bit sockets 1/2", ribe
PAGE 399
-  > Bit sockets 1/2", impact ball joint
PAGE 400
-  > Impact bit sockets 1/2", spline
PAGE 400
-  > Impact bit sockets 1/2", ribe
PAGE 400
-  > Impact bit sockets 3/4", spline
PAGE 400
-  > Bits 1/4", PH
PAGE 400
-  > Bits 1/4", slotted
PAGE 400
-  > Bits 1/4", hex
PAGE 401
-  > Bits 1/4", spline
PAGE 401
-  > Bits 5/16", PH
PAGE 401
-  > Bits 5/16", PZ
PAGE 401
-  > Bits 5/16", slotted
PAGE 401
-  > Bits 5/16", hex
PAGE 401
-  > Bits 5/16", TX
PAGE 402
-  > Bits 5/16", spline
PAGE 402
-  > Bits 10mm, hex
PAGE 402
-  > Bits 10mm, TX
PAGE 402
-  > Bits 10mm, spline
PAGE 402

BIT SOCKET PH 1/4"

DIN NO. 3120



6.3
1/4"



ART. NO.	SIZE	L(MM)	L1(MM)	D(MM)	G	PCS/BAG
8113700	PH.0	37	16	12	14	10
8113701	PH.1	37	16	12	14	10
8113702	PH.2	37	16	12	14	10
8113703	PH.3	37	16	12	16	10

BIT SOCKET PZ 1/4"

DIN NO. 3120



6.3
1/4"



ART. NO.	SIZE	L(MM)	L1(MM)	D(MM)	G	PCS/BAG
8123700	PZ.0	37	16	12	14	10
8123701	PZ.1	37	16	12	14	10
8123702	PZ.2	37	16	12	14	10
8123703	PZ.3	37	16	12	16	10

BIT SOCKET SLOTTED 1/4"

DIN NO. 3120



6.3
1/4"



ART. NO.	SIZE	L(MM)	L1(MM)	D(MM)	G	PCS/BAG
8133704	4	37	16	12	14	10
81337055	5.5	37	16	12	14	10
81337065	6.5	37	16	12	16	10

BIT SOCKET HEX 1/4"

DIN NO. 3120



6.3
1/4"



ART. NO.	SIZE	L(MM)	L1(MM)	D(MM)	G	PCS/BAG
8143703	3	37	16	12	14	10
8143704	4	37	16	12	16	10
8143705	5	37	16	12	16	10
81437055	5.5	37	16	12	16	10
8143706	6	37	16	12	16	10
8143707	7	37	16	13	20	10
8143708	8	37	16	13	22	10
8143709	9	37	16	13	24	10
8143710	10	37	16	13	26	10

BIT SOCKET HEX BALL 1/4"

DIN NO. 3120



6.3
1/4"



ART. NO.	SIZE	L(MM)	L1(MM)	D(MM)	G	PCS/BAG
8103703	3	37	16	12	14	10
8103704	4	37	16	12	16	10
8103705	5	37	16	12	16	10
81037055	5.5	37	16	12	16	10
8103706	6	37	16	12	16	10
8103707	7	37	16	13	20	10
8103708	8	37	16	13	22	10
8103709	9	37	16	13	24	10
8103710	10	37	16	13	26	10

BIT SOCKET HEX 1/4" (SAE)

DIN NO. 3120



6.3
1/4"



ART. NO.	SIZE	L(MM)	L1(MM)	D(MM)	G	PCS/BAG
81413703	1/8"	37	16	12	15	10
81413704	5/32"	37	16	12	15	10
81413705	3/16"	37	16	12	15	10
81413706	7/32"	37	16	12	15	10
81413707	1/4"	37	16	12	15	10
81413708	5/16"	37	16	13	20	10
81413710	3/8"	37	16	13	25	10

BIT SOCKET TX 1/4"

DIN NO. 3120



6.3
1/4"



ART. NO.	SIZE	L(MM)	L1(MM)	D(MM)	G	PCS/BAG
8163706	T6	37	16	12	14	10
8163707	T7	37	16	12	14	10
8163708	T8	37	16	12	14	10
8163709	T9	37	16	12	14	10
8163710	T10	37	16	12	14	10
8163715	T15	37	16	12	16	10
8163720	T20	37	16	12	16	10
8163725	T25	37	16	12	16	10
8163727	T27	37	16	12	16	10
8163730	T30	37	16	12	16	10
8163740	T40	37	16	12	16	10

Sonic bit sockets

BIT SOCKET TX BALL 1/4"

DIN NO. 3120



6.3
1/4"



ART. NO.	SIZE	L(MM)	L1(MM)	D(MM)	G	PCS/BAG
81613710	T10	37	16	12	14	10
81613715	T15	37	16	12	14	10
81613720	T20	37	16	12	14	10
81613725	T25	37	16	12	14	10
81613727	T27	37	16	12	14	10
81613730	T30	37	16	12	14	10
81613740	T40	37	16	12	14	10

BIT SOCKET SPLINE 1/4"

DIN NO. 3120



6.3
1/4"



ART. NO.	SIZE	L(MM)	L1(MM)	D(MM)	G	PCS/BAG
8183704	M4	37	16	12	14	10
8183705	M5	37	16	12	16	10
8183706	M6	37	16	12	16	10
8183708	M8	37	16	13	20	10
8183710	M10	37	16	13	24	10

BIT SOCKET TX TAMPERPROOF 1/4"

DIN NO. 3120



6.3
1/4"



ART. NO.	SIZE	L(MM)	L1(MM)	D(MM)	G	PCS/BAG
8173706	T6H	37	16	12	14	10
8173707	T7H	37	16	12	14	10
8173708	T8H	37	16	12	14	10
8173709	T9H	37	16	12	14	10
8173710	T10H	37	16	12	14	10
8173715	T15H	37	16	12	14	10
8173720	T20H	37	16	12	14	10
8173725	T25H	37	16	12	14	10
8173727	T27H	37	16	12	16	10
8173730	T30H	37	16	12	16	10
8173740	T40H	37	16	12	16	10

BIT SOCKET RIBE 1/4"

DIN NO. 3120



6.3
1/4"



ART. NO.	SIZE	L(MM)	L1(MM)	D(MM)	G	PCS/BAG
8193704	M4	37	16	12	14	10
8193705	M5	37	16	12	16	10
8193706	M6	37	16	12	16	10
8193707	M7	37	16	12	16	10
8193708	M8	37	16	13	20	10
8193710	M10	37	16	13	24	10

BIT SOCKET PH 3/8"

DIN NO. 3120



10
3/8"



ART. NO.	SIZE	L(MM)	L1(MM)	D(MM)	G	PCS/BAG
8214801	PH.1	48	20	18	34	10
8214802	PH.2	48	20	18	34	10
8214803	PH.3	48	20	18	34	10

TAMPER-RESISTANT 1/4", TX PLUS (5 LOBES)

DIN NO. 3120



6.3
1/4"



ART. NO.	SIZE	L(MM)	L1(MM)	D(MM)	G	PCS/BAG
8153708	8IPR	37	16	12	14	10
8153710	10IPR	37	16	12	14	10
8153715	15IPR	37	16	12	14	10
8153720	20IPR	37	16	12	14	10
8153725	25IPR	37	16	12	14	10
8153727	27IPR	37	16	12	16	10
8153730	30IPR	37	16	12	16	10
8153740	40IPR	37	16	12	16	10
8153745	45IPR	37	16	13	20	10
8153750	50IPR	37	16	13	22	10

BIT SOCKET PZ 3/8"

DIN NO. 3120



10
3/8"



ART. NO.	SIZE	L(MM)	L1(MM)	D(MM)	G	PCS/BAG
8224801	PZ.1	48	20	18	34	10
8224802	PZ.2	48	20	18	34	10
8224803	PZ.3	48	20	18	34	10

BIT SOCKET SLOTTED 3/8"

DIN NO. 3120



10
3/8"



ART. NO.	SIZE	L(MM)	L1(MM)	D(MM)	G	PCS/BAG
82348055	5.5	48	20	18	32	10
8234806	6	48	20	18	32	10
8234807	7	48	20	18	36	10
8234808	8	48	20	18	38	10

BIT SOCKET HEX 3/8"

DIN NO. 3120



10
3/8"



ART. NO.	SIZE	L(MM)	L1(MM)	D(MM)	G	PCS/BAG
8244803	3	48	20	18	32	10
8244804	4	48	20	18	32	10
8244805	5	48	20	18	32	10
82448055	5.5	48	20	18	34	10
8244806	6	48	20	18	34	10
8244807	7	48	20	18	36	10
8244808	8	48	20	18	38	10
8244809	9	48	20	18	48	10
8244810	10	48	20	18	50	10
8244811	11	48	20	18	50	10
8244812	12	48	20	18	52	10

BIT SOCKET HEX 3/8", 90MML

DIN NO. 3120



10
3/8"



ART. NO.	SIZE	L(MM)	L1(MM)	D(MM)	G	PCS/BAG
8249003	3	90	62	18	44	10
8249004	4	90	62	18	44	10
8249005	5	90	62	18	44	10
82490055	5.5	90	62	18	46	10
8249006	6	90	62	18	46	10
8249007	7	90	62	18	50	10
8249008	8	90	62	18	58	10
8249009	9	90	62	18	76	10
8249010	10	90	62	18	78	10
8249011	11	90	62	18	78	10

BIT SOCKET HEX BALL 3/8", 90MML

DIN NO. 3120



10
3/8"



ART. NO.	SIZE	L(MM)	L1(MM)	D(MM)	G	PCS/BAG
8209003	3	90	62	18	44	10
8209004	4	90	62	18	44	10
8209005	5	90	62	18	44	10
82090055	5.5	90	62	18	46	10
8209006	6	90	62	18	46	10
8209007	7	90	62	18	50	10
8209008	8	90	62	18	58	10
8209009	9	90	62	18	76	10
8209010	10	90	62	18	78	10

BIT SOCKET HEX 3/8" (SAE)

DIN NO. 3120



10
3/8"



ART. NO.	SIZE	L(MM)	L1(MM)	D(MM)	G	PCS/BAG
82414803	1/8"	48	20	18	35	10
82414804	5/32"	48	20	18	35	10
82414805	3/16"	48	20	18	35	10
824148055	7/32"	48	20	18	35	10
82414806	1/4"	48	20	18	35	10
82414808	5/16"	48	20	18	40	10
82414810	3/8"	48	20	18	50	10
82414812	7/16"	48	20	18	55	10
82414813	1/2"	48	20	18	60	10

BIT SOCKET TX 3/8"

DIN NO. 3120



10
3/8"



ART. NO.	SIZE	L(MM)	L1(MM)	D(MM)	G	PCS/BAG
8264808	T8	48	20	18	32	10
8264810	T10	48	20	18	32	10
8264815	T15	48	20	18	32	10
8264820	T20	48	20	18	32	10
8264825	T25	48	20	18	32	10
8264827	T27	48	20	18	32	10
8264830	T30	48	20	18	32	10
8264840	T40	48	20	18	34	10
8264845	T45	48	20	18	36	10
8264850	T50	48	20	18	38	10
8264855	T55	48	20	18	50	10
8264860	T60	48	20	18	54	10

Sonic bit sockets

BIT SOCKET TX 3/8", 90MML

DIN NO. 3120



10
3/8"



ART. NO.	SIZE	L(MM)	L1(MM)	D(MM)	G	PCS/BAG
8269008	T8	90	62	18	44	10
8269010	T10	90	62	18	44	10
8269015	T15	90	62	18	44	10
8269020	T20	90	62	18	44	10
8269025	T25	90	62	18	44	10
8269027	T27	90	62	18	44	10
8269030	T30	90	62	18	44	10
8269040	T40	90	62	18	44	10
8269045	T45	90	62	18	52	10
8269050	T50	90	62	18	58	10

BIT SOCKET SPLINE 3/8"

DIN NO. 3120



10
3/8"



ART. NO.	SIZE	L(MM)	L1(MM)	D(MM)	G	PCS/BAG
8284804	M4	48	20	18	30	10
8284805	M5	48	20	18	32	10
8284806	M6	48	20	18	34	10
8284808	M8	48	20	18	36	10
8284809	M9	48	20	18	48	10
8284810	M10	48	20	18	50	10
8284812	M12	48	20	18	54	10

BIT SOCKET TX TAMPERPROOF 3/8"

DIN NO. 3120



10
3/8"



ART. NO.	SIZE	L(MM)	L1(MM)	D(MM)	G	PCS/BAG
8274808	T8H	48	20	18	32	10
8274810	T10H	48	20	18	32	10
8274815	T15H	48	20	18	32	10
8274820	T20H	48	20	18	32	10
8274825	T25H	48	20	18	32	10
8274827	T27H	48	20	18	32	10
8274830	T30H	48	20	18	32	10
8274840	T40H	48	20	18	34	10
8274845	T45H	48	20	18	36	10
8274850	T50H	48	20	18	36	10
8274855	T55H	48	20	18	50	10
8274860	T60H	48	20	18	52	10

BIT SOCKET SPLINE 3/8", 90MML

DIN NO. 3120



10
3/8"



ART. NO.	SIZE	L(MM)	L1(MM)	D(MM)	G	PCS/BAG
8289005	M5	90	62	18	44	10
8289006	M6	90	62	18	46	10
8289008	M8	90	62	18	56	10
8289009	M9	90	62	18	76	10
8289010	M10	90	62	18	78	10
8289012	M12	90	62	18	92	10

BIT SOCKET RIBE 3/8"

DIN NO. 3120



10
3/8"



ART. NO.	SIZE	L(MM)	L1(MM)	D(MM)	G	PCS/BAG
8294804	M4	48	20	18	30	10
8294805	M5	48	20	18	32	10
8294806	M6	48	20	18	34	10
8294807	M7	48	20	18	36	10
8294808	M8	48	20	18	36	10
8294809	M9	48	20	18	48	10
8294810	M10	48	20	18	50	10
8294812	M12	48	20	18	54	10

BIT SOCKET TX TAMPERPROOF 3/8", 90MML

DIN NO. 3120



10
3/8"



ART. NO.	SIZE	L(MM)	L1(MM)	D(MM)	G	PCS/BAG
8279008	T8H	90	62	18	44	10
8279010	T10H	90	62	18	44	10
8279015	T15H	90	62	18	44	10
8279020	T20H	90	62	18	44	10
8279025	T25H	90	62	18	44	10
8279027	T27H	90	62	18	44	10
8279030	T30H	90	62	18	44	10
8279040	T40H	90	62	18	48	10
8279045	T45H	90	62	18	52	10
8279050	T50H	90	62	18	58	10

BIT SOCKET RIBE 3/8", 90MML

DIN NO. 3120



10
3/8"



ART. NO.	SIZE	L(MM)	L1(MM)	D(MM)	G	PCS/BAG
8299005	M5	90	62	18	45	10
8299006	M6	90	62	18	45	10
8299007	M7	90	62	18	55	10
8299008	M8	90	62	18	57	10
8299009	M9	90	62	18	77	10
8299010	M10	90	62	18	79	10
8299012	M12	90	62	18	83	10

BIT SOCKET HEX 1/2", 140MML

DIN NO. 3120



12.5
1/2"



ART. NO.	SIZE	L(MM)	L1(MM)	D(MM)	G	PCS/BAG
83414007	7	140	102	24	121	10
83414010	10	140	102	22	132	10
83414011	11	140	102	24	183	10
83414013	13	140	102	24	202	10
83414014	14	140	102	24	220	10

BIT SOCKET HEX 1/2"

DIN NO. 3120



12.5
1/2"



ART. NO.	SIZE	L(MM)	L1(MM)	D(MM)	G	PCS/BAG
83406204	4	62	24	22	70	10
83406205	5	62	24	22	70	10
83406255	5.5	62	24	22	70	10
83406206	6	62	24	22	70	10
83406207	7	62	24	22	70	10
83406208	8	62	24	22	70	10
83406209	9	62	24	22	80	10
83406210	10	62	24	22	80	10
83406212	12	62	24	24	110	10
83406214	14	62	24	24	125	10
83406217	17	62	24	24	140	10
83406219	19	62	24	24	150	10
83406222	22	62	24	25	180	10
83406224	24	62	24	27	200	10

BIT SOCKET HEX 1/2", 248MML

DIN NO. 3120



12.5
1/2"



ART. NO.	SIZE	L(MM)	L1(MM)	D(MM)	G	PCS/BAG
83424806	6	248	210	22	150	10

BIT SOCKET HEX BALL 1/2", 100MML

DIN NO. 3120



12.5
1/2"



ART. NO.	SIZE	L(MM)	L1(MM)	D(MM)	G	PCS/BAG
83010005	5	100	62	22	84	10
830100055	5.5	100	62	22	84	10
83010006	6	100	62	22	84	10
83010007	7	100	62	22	86	10
83010008	8	100	62	22	86	10
83010009	9	100	62	22	104	10
83010010	10	100	62	22	106	10
83010012	12	100	62	24	142	10

BIT SOCKET HEX 1/2", 100MML

DIN NO. 3120



12.5
1/2"



ART. NO.	SIZE	L(MM)	L1(MM)	D(MM)	G	PCS/BAG
83410005	5	100	62	22	84	10
83410006	6	100	62	22	84	10
83410007	7	100	62	22	86	10
83410008	8	100	62	22	86	10
83410009	9	100	62	22	104	10
83410010	10	100	62	22	106	10
83410011	11	100	62	24	144	10
83410012	12	100	62	24	142	10
83410013	13	100	62	24	144	10
83410014	14	100	62	24	172	10
83410017	17	100	62	24	212	10

BIT SOCKET HEX BALL 1/2", 140MML

DIN NO. 3120



12.5
1/2"



ART. NO.	SIZE	L(MM)	L1(MM)	D(MM)	G	PCS/BAG
83014005	5	140	102	24	119	10
83014006	6	140	102	24	120	10
83014007	7	140	102	24	121	10
83014008	8	140	102	24	122	10
83014010	10	140	102	24	150	10
83014012	12	140	102	24	183	10

Sonic bit sockets

BIT SOCKET HEX 1/2" (SAE)

DIN NO. 3120



12.5
1/2"



ART. NO.	SIZE	L(MM)	L1(MM)	D(MM)	G	PCS/BAG
834106205	3/16"	62	24	22	65	10
834106206	1/4"	62	24	22	65	10
834106207	9/32"	62	24	22	70	10
834106208	5/16"	62	24	22	70	10
834106209	11/32"	62	24	22	80	10
834106210	3/8"	62	24	22	80	10
834106212	7/16"	62	24	22	85	10
834106213	1/2"	62	24	24	110	10
834106214	9/16"	62	24	24	125	10
834106217	5/8"	62	24	24	135	10

TX BIT SOCKET 1/2", 140MML

DIN NO. 3120



12.5
1/2"



ART. NO.	SIZE	L(MM)	L1(MM)	D(MM)	G	PCS/BAG
83614040	T40	140	102	22	120	10
83614045	T45	140	102	22	121	10
83614050	T50	140	102	22	121	10
83614055	T55	140	102	22	149	10
83614060	T60	140	102	24	180	10
83614070	T70	140	102	24	217	10

BIT SOCKET TX 1/2"

DIN NO. 3120



12.5
1/2"



ART. NO.	SIZE	L(MM)	L1(MM)	D(MM)	G	PCS/BAG
83606220	T20	62	24	22	65	10
83606225	T25	62	24	22	65	10
83606227	T27	62	24	22	65	10
83606230	T30	62	24	22	65	10
83606240	T40	62	24	22	65	10
83606245	T45	62	24	22	70	10
83606250	T50	62	24	22	70	10
83606255	T55	62	24	22	80	10
83606260	T60	62	24	24	105	10
83606270	T70	62	24	24	125	10

BIT SOCKET TX TAMPERPROOF 1/2"

DIN NO. 3120



12.5
1/2"



ART. NO.	SIZE	L(MM)	L1(MM)	D(MM)	G	PCS/BAG
83706220	T20H	62	24	22	65	10
83706225	T25H	62	24	22	65	10
83706227	T27H	62	24	22	65	10
83706230	T30H	62	24	22	65	10
83706240	T40H	62	24	22	70	10
83706245	T45H	62	24	22	70	10
83706250	T50H	62	24	22	70	10
83706255	T55H	62	24	22	80	10
83706260	T60H	62	24	24	105	10
83706270	T70H	62	24	24	120	10

BIT SOCKET TX 1/2", 100MML

DIN NO. 3120



12.5
1/2"



ART. NO.	SIZE	L(MM)	L1(MM)	D(MM)	G	PCS/BAG
83610020	T20	100	62	22	84	10
83610025	T25	100	62	22	84	10
83610027	T27	100	62	22	84	10
83610030	T30	100	62	22	86	10
83610040	T40	100	62	22	84	10
83610045	T45	100	62	22	86	10
83610050	T50	100	62	22	86	10
83610055	T55	100	62	22	104	10
83610060	T60	100	62	24	142	10
83610070	T70	100	62	24	168	10
83610080	T80	100	62	24	292	10
83610090	T90	100	62	24	292	10
83610100	T100	100	62	24	358	10

BIT SOCKET TX TAMPERPROOF 1/2", 100MML

DIN NO. 3120



12.5
1/2"



ART. NO.	SIZE	L(MM)	L1(MM)	D(MM)	G	PCS/BAG
83710020	T20H	100	62	22	84	10
83710025	T25H	100	62	22	84	10
83710027	T27H	100	62	22	84	10
83710030	T30H	100	62	22	86	10
83710040	T40H	100	62	22	84	10
83710045	T45H	100	62	22	86	10
83710050	T50H	100	62	22	86	10
83710055	T55H	100	62	22	104	10
83710060	T60H	100	62	24	140	10
83710070	T70H	100	62	24	166	10
83710080	T80H	100	62	24	292	10

BIT SOCKET SPLINE 1/2"

DIN NO. 3120 

12.5
1/2"



ART. NO.	SIZE	L(MM)	L1(MM)	D(MM)	G	PCS/BAG
83806205	M5	62	24	22	70	10
83806206	M6	62	24	22	70	10
83806208	M8	62	24	22	70	10
83806209	M9	62	24	22	75	10
83806210	M10	62	24	22	80	10
83806212	M12	62	24	24	105	10
83806214	M14	62	24	24	120	10
83806216	M16	62	24	24	130	10
83806216T	M16T	62	24	24	125	10

BIT SOCKET SPLINE 1/2", 100MML

DIN NO. 3120 

12.5
1/2"



ART. NO.	SIZE	L(MM)	L1(MM)	D(MM)	G	PCS/BAG
83810005	M5	100	62	22	84	10
83810006	M6	100	62	22	84	10
83810008	M8	100	62	22	84	10
83810009	M9	100	62	22	104	10
83810010	M10	100	62	22	102	10
83810012	M12	100	62	24	138	10
83810014	M14	100	62	24	166	10
83810016	M16	100	62	24	184	10
83810016T	M16T	100	62	24	193	10

BIT SOCKET SPLINE 1/2", 140MML

DIN NO. 3120 

12.5
1/2"



ART. NO.	SIZE	L(MM)	L1(MM)	D(MM)	G	PCS/BAG
83814010	M10	140	102	22	148	10
83814012	M12	140	102	24	178	10
83814014	M14	140	102	24	215	10

BIT SOCKET SPLINE 1/2", 800MML

DIN NO. 3120 

12.5
1/2"



ART. NO.	SIZE	L(MM)	L1(MM)	D(MM)	G	PCS/BAG
83880008	M8	800	762	22	90	10
83880010	M10	800	762	22	90	10

BIT SOCKET RIBE 1/2"

DIN NO. 3120 

12.5
1/2"



ART. NO.	SIZE	L(MM)	L1(MM)	D(MM)	G	PCS/BAG
83906205	M5	62	24	22	68	10
83906206	M6	62	24	22	70	10
83906207	M7	62	24	22	70	10
83906208	M8	62	24	22	70	10
83906209	M9	62	24	22	80	10
83906210	M10	62	24	22	80	10
83906211	M10-1	62	24	22	80	10
83906212	M12	62	24	24	105	10
83906213	M13	62	24	24	120	10
83906214	M14	62	24	24	120	10
83906216	M16	62	24	24	130	10

BIT SOCKET RIBE 1/2", 100MML

DIN NO. 3120 

12.5
1/2"



ART. NO.	SIZE	L(MM)	L1(MM)	D(MM)	G	PCS/BAG
83910005	M5	100	62	22	85	10
83910006	M6	100	62	22	86	10
83910007	M7	100	62	22	86	10
83910008	M8	100	62	22	86	10
83910009	M9	100	62	22	102	10
83910010	M10	100	62	22	105	10
83910012	M12	100	62	24	140	10
83910013	M13	100	62	24	165	10
83910014	M14	100	62	24	165	10
83910016	M16	100	62	27	193	10

BIT SOCKET RIBE 1/2", 120MML

DIN NO. 3120 

12.5
1/2"



ART. NO.	SIZE	L(MM)	L1(MM)	D(MM)	G	PCS/BAG
83912011	M10-1	120	82	24	127	10

Especially for Fiat

BIT SOCKET RIBE 1/2", 140MML

DIN NO. 3120 

12.5
1/2"



ART. NO.	SIZE	L(MM)	L1(MM)	D(MM)	G	PCS/BAG
83914010	M10	140	102	24	178	10

Especially for VW

Sonic bit sockets

BIT SOCKET RIBE 1/2", 240MML

DIN NO. 3120



12.5
1/2"



ART. NO.	SIZE	L(MM)	L1(MM)	D(MM)	G	PCS/BAG
83924007	M7	240	202	24	190	10
83924008	M8	240	202	24	194	10

IMPACT BALL JOINT BIT SOCKET SPLINE 1/2" 130MML

DIN NO. 3121



12.5
1/2"



ART. NO.	SIZE	L(MM)	L1(MM)	D(MM)	G	PCS/BAG
7150108	M8	130	92	22	180	10
7150110	M10	130	92	22	180	10

IMPACT BIT SOCKET SPLINE 1/2", 78MML



12.5
1/2"



ART. NO.	SIZE	L(MM)	D(MM)	G	PCS/BAG
86807818	M18	78	25	150	10

BIT SOCKET IMPACT SPLINE 3/4"



20
3/4"



ART. NO.	SIZE	L(MM)	D(MM)	G	PCS/BAG
87810518	M18	105	40	396	1

BIT SOCKET IMPACT RIBE 1/2", ONE-PIECE 78MML

DIN NO. 3121



12.5
1/2"



ART. NO.	SIZE	L(MM)	D(MM)	G	PCS/BAG
86907805	M5	78	25	78	10
86907806	M6	78	25	76	10
86907807	M7	78	25	82	10
86907808	M8	78	25	84	10
86907809	M9	78	25	92	10
86907810	M10	78	25	96	10
86907812	M12	78	25	110	10
86907813	M13	78	25	120	10
86907814	M14	78	25	124	10



Bits will be delivered in a 5 piece blister package

BIT PH 1/4", 25MML



6.3
1/4"



ART. NO.	SIZE	L(MM)	D(MM)	G	PCS/BAG
9112501	PH.1	25	6.3	4	5
9112502	PH.2	25	6.3	4	5
9112503	PH.3	25	6.3	6	5

BIT SLOTTED 1/4", 25MML



6.3
1/4"



ART. NO.	SIZE	L(MM)	D(MM)	G	PCS/BAG
9132503	3	25	6.3	4	5
9132504	4	25	6.3	4	5
9132505	5	25	6.3	4	5
9132506	6	25	6.3	6	5

BIT HEX 1/4", 25MML



6.3
1/4"

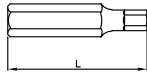

ART. NO.	SIZE	L(MM)	D(MM)	G	PCS/BAG
9142503	3	25	6.3	4	5
9142504	4	25	6.3	4	5
9142505	5	25	6.3	6	5

BIT SLOTTED 5/16", 30MML

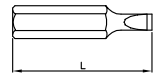

ART. NO.	SIZE	L(MM)	D(MM)	G	PCS/BAG
9233008	8	30	7.9	10	5
9233010	10	30	7.9	16	5
9233012	12	30	7.9	20	5

BIT SPLINE 1/4", 25MML

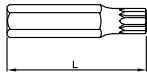

ART. NO.	SIZE	L(MM)	D(MM)	G	PCS/BAG
9182504	M4	25	6.3	14	5
9182505	M5	25	6.3	14	5

BIT SLOTTED 5/16", 36MML

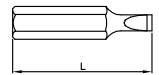

ART. NO.	SIZE	L(MM)	D(MM)	G	PCS/BAG
9233605	5	36	7.9	12	5
9233606	6	36	7.9	12	5
9233608	8	36	7.9	14	5
9233610	10	36	7.9	14	5
9233612	12	36	7.9	16	5

BIT PH 5/16", 30MML

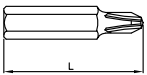

ART. NO.	SIZE	L(MM)	D(MM)	G	PCS/BAG
9213001	PH.1	30	7.9	10	5
9213002	PH.2	30	7.9	10	5
9213003	PH.3	30	7.9	10	5
9213004	PH.4	30	7.9	10	5

BIT HEX 5/16", 30MML

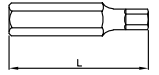

ART. NO.	SIZE	L(MM)	D(MM)	G	PCS/BAG
9243007	7	30	7.9	14	5
9243008	8	30	7.9	14	5
9243010	10	30	7.9	14	5
9243012	12	30	7.9	16	5
9243014	14	30	7.9	26	5

BIT PH 5/16", 36MML

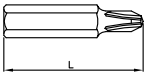

ART. NO.	SIZE	L(MM)	D(MM)	G	PCS/BAG
9213601	PH.1	36	7.9	12	5
9213602	PH.2	36	7.9	12	5
9213603	PH.3	36	7.9	12	5
9213604	PH.4	36	7.9	12	5

BIT HEX 5/16", 36MML

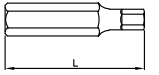

ART. NO.	SIZE	L(MM)	D(MM)	G	PCS/BAG
9243604	4	36	7.9	12	5
9243605	5	36	7.9	14	5
9243606	6	36	7.9	14	5
9243608	8	36	7.9	14	5

BIT PZ 5/16", 30MML

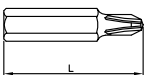

ART. NO.	SIZE	L(MM)	D(MM)	G	PCS/BAG
9223002	PZ.2	30	7.9	10	5
9223003	PZ.3	30	7.9	10	5
9223004	PZ.4	30	7.9	12	5

Sonic bit sockets

BIT TX 5/16", 30MML



ART. NO.	SIZE	L(MM)	D(MM)	G	PCS/BAG
9263040	T40	30	7.9	10	5
9263045	T45	30	7.9	12	5
9263050	T50	30	7.9	12	5
9263055	T55	30	7.9	14	5

BIT SPLINE 5/16", 30MM



ART. NO.	SIZE	L(MM)	D(MM)	G	PCS/BAG
9283006	M6	30	7.9	14	5
9283008	M8	30	7.9	14	5
9283010	M10	30	7.9	14	5

BIT HEX 10MM, 30MML



ART. NO.	SIZE	L(MM)	D(MM)	G	PCS/BAG
9343004	4	30	10	14	5
9343005	5	30	10	14	5
9343006	6	30	10	14	5
9343007	7	30	10	14	5
9343008	8	30	10	18	5
9343010	10	30	10	20	5
9343012	12	30	10	24	5

BIT HEX 10MM, 75MML



ART. NO.	SIZE	L(MM)	D(MM)	G	PCS/BAG
9347504	4	75	10	42	5
9347505	5	75	10	38	5
9347506	6	75	10	44	5
9347507	7	75	10	46	5
9347508	8	75	10	46	5
9347510	10	75	10	50	5
9347512	12	75	10	64	5

BIT TX 10MM, 30MML

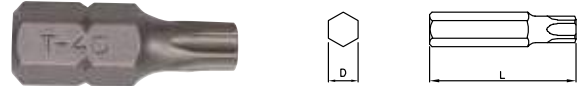

ART. NO.	SIZE	L(MM)	D(MM)	G	PCS/BAG
9363020	T20	30	10	12	5
9363025	T25	30	10	12	5
9363030	T30	30	10	14	5
9363040	T40	30	10	14	5
9363045	T45	30	10	16	5
9363050	T50	30	10	16	5
9363055	T55	30	10	16	5
9363060	T60	30	10	18	5

BIT TX 10MM, 75MML



ART. NO.	SIZE	L(MM)	D(MM)	G	PCS/BAG
9367520	T20	75	10	22	5
9367525	T25	75	10	40	5
9367530	T30	75	10	42	5
9367540	T40	75	10	44	5
9367545	T45	75	10	44	5
9367550	T50	75	10	46	5
9367555	T55	75	10	48	5
9367560	T60	75	10	66	5

BIT SPLINE 10MM, 30MML



ART. NO.	SIZE	L(MM)	D(MM)	G	PCS/BAG
9383005	M5	30	10	14	5
9383006	M6	30	10	14	5
9383008	M8	30	10	16	5
9383010	M10	30	10	18	5
9383012	M12	30	10	20	5

BIT SPLINE 10MM, 75MML



ART. NO.	SIZE	L(MM)	D(MM)	G	PCS/BAG
9387505	M5	75	10	42	5
9387506	M6	75	10	42	5
9387508	M8	75	10	44	5
9387510	M10	75	10	46	5
9387512	M12	75	10	54	5

Promotional items

75166 - SONIC KEY CORD



75115 - SONIC SOCKET KEY RING



75195 - SONIC TENT 3 X 3M



75104... - SONIC CATALOG



75185 - SONIC FLAG 11"



ART. NO.	CONTENTS
----------	----------

75188	SONIC TENT (FRAME) 3 X 3M
-------	---------------------------

75189	SONIC TENT (CLOTH) 3 X 3M
-------	---------------------------

ART. NO.	CONTENTS
----------	----------

75104ENG	Catalog English
----------	-----------------

75104DE	Catalog German
---------	----------------

75193 - DISC RATCHET 1/4", 72 TEETH GIVE AWAY (BLACK)



75105... - GLOBAL BESTSELLERS



75192 - SONIC BOTTLE OPENER



47828 - SCREWDRIVER TRY ME



ART. NO.	CONTENTS
----------	----------

75105DE	Global bestsellers German
---------	---------------------------

75105NL	Global bestsellers Dutch
---------	--------------------------

75105ENG	Global bestsellers English
----------	----------------------------

75105IT	Global bestsellers Italian
---------	----------------------------

75105FR	Global bestsellers France
---------	---------------------------

200804 - SAMPLE SET SONIC, 8PCS. BMCS



7521... - SONIC KEY RING



75194 - SONIC TENT 3 X 4.5M



ART. NO.	CONTENTS
----------	----------

75186	SONIC tent (frame) 3 x 4.5m
-------	-----------------------------

75187	SONIC Tent (cloth) 3 x 4.5m
-------	-----------------------------

ART. NO.	CONTENTS
----------	----------

75211	Key ring MSS+
-------	---------------

75212	Key ring Sonic
-------	----------------

Promotional items

751... - SONIC POLO SHIRT



ART. NO.	CONTENTS
75196	Sonic polo shirt size S
75197	Sonic polo shirt size M
75198	Sonic polo shirt size L
75199	Sonic polo shirt size XL
75200	Sonic polo shirt size XXL

751... - SONIC T-SHIRT



ART. NO.	CONTENTS
75150S	Sonic t-shirt size S
75150M	Sonic t-shirt size M
75150L	Sonic t-shirt size L
75150XL	Sonic t-shirt size XL
751502XL	Sonic t-shirt size XXL

752... - SONIC SWEATER



ART. NO.	CONTENTS
75201	Sonic sweater S
75202	Sonic sweater M
75203	Sonic sweater L
75204	Sonic sweater XL

75209 - HOODED CROSS OVER JACKET, BLACK



ART. NO.	CONTENTS
75209L	Hooded cross over jacket, black L
75209M	Hooded cross over jacket, black M
75209XL	Hooded cross over jacket, black XL
75209XXL	Hooded cross over jacket, black XXL

75208 - CROSS OVER JACKET, BLACK/BLACK



ART. NO.	CONTENTS
75208L	Cross over jacket, black/black L
75208M	Cross over jacket, black/black M
75208XL	Cross over jacket, black/black XL
75208XXL	Cross over jacket, black/black XXL

75210 - HOODED ZEPELIN OVER JACKET, BLACK/BLACK



ART. NO.	CONTENTS
75210L	Hooded zepelin over jacket, black/black L
75210M	Hooded zepelin over jacket, black/black M
75210XL	Hooded zepelin over jacket, black/black XL
75210XXL	Hooded zepelin over jacket, black/black XXL

Warranty conditions

Definitions

The following definitions apply in the warranty conditions:

End User: the natural or legal person who has purchased a Product from a Sonic Retailer for personal use, without the intention to sell the Product to third parties or install it at the premises of others.

Products: all goods, usage rights and other proprietary rights of (the label) Sonic which are sold via authorised Sonic Retailers and destined for End Users.

Sonic: Sonic Equipment BV, a private company with limited liability, registered in Purmerend, the Netherlands, and with its place of business at Component 114, 1446 WP Purmerend, the Netherlands (Chamber of Commerce No. 37113345) and its affiliates.

Sonic Retailer: any sales outlet of a natural or legal person exercising a profession or business, and which is authorised by Sonic to sell Products to End Users as a reseller of Sonic Equipment BV.

Sonic Warranty: the warranty in these Warranty Conditions for End Users of Products.

Warranty Conditions: these warranty conditions of Sonic Equipment BV which apply to Products of Sonic that are sold to End Users through authorised Sonic Retailers.

Definitions can be used in both singular and plural, without loss of substantive meaning.

General

Sonic only supplies Products through Sonic owned channels and Sonic Retailers. Products are manufactured for intensive and professional use. All Products are manufactured and put together with the utmost care, and they undergo the most stringent quality and production controls. Nevertheless, problems with material and/or workmanship may arise. The Sonic Warranty only warrants defects in workmanship or materials that prevent their use and to the extent set out in these Warranty Conditions. The Sonic Warranty does not include any right to indemnification or compensation in any form whatsoever. Sonic is and shall not be liable for any incidental, special or consequential losses, costs or damages.

The Warranty Conditions do not affect mandatory legal warranty obligations in any way.

Warranty:

The length of the warranty is always dependent on the Product concerned, and is specified in the Catalog and/or on the Sonic website. The warranty commences when the End User purchases the Product. The Sonic Warranty is only valid upon presentation of proof of purchase of the Product with clear date of purchase, and subject to registration of the Product to the extent required. The Sonic Warranty for storage systems is only valid if the storage system is properly registered on the Sonic website. The Sonic Warranty is not transferable and only valid for the End User who directly purchases a Product from a Sonic Retailer. It is not valid for subsequent users. The End User must report to the Sonic Retailer when making a claim under the Sonic Warranty.

If Sonic considers that a Product is covered by the Sonic Warranty, it will repair or replace the Product at its sole discretion, taken into account the duration of the use of the Product. Replaced Products become the property of Sonic. If a Product is no longer in Sonic's

range, Sonic may at its sole discretion supply a similar Product or provide a refund by means of a voucher.

Any work performed under warranty must be carried out by Sonic. The shipping costs for assessing the Sonic Warranty must be borne by the sender. The Sonic Warranty covers parts, labour and return to sender. Replaced and repaired Products are also covered by the Sonic Warranty. The length of the Sonic Warranty is not extended or renewed if parts are replaced, repaired or supplied.

Sonic regularly changes and improves various Products according to market demands and/or improvements in technology. Products listed in the Catalog are subject to changes of both a technical and visual nature, without further notice. Sonic reserves the right to make changes in design, construction or technology at any time without incurring any obligation in incorporating such changes in Products of Sonic previously sold or sent for repair.

Length of the Warranty

Sonic offers four warranty options in addition to the legal warranty. Unless specified otherwise, the Sonic Warranty is for a period of 10 years.

SG3: This warranty is for a period of 3 years.

SG2: This warranty is for a period of 2 years.

SG1: This warranty is for a period of 1 year.

SGX: These items have no warranty.

Warranty exclusions

The Sonic Warranty does not cover the following situations and/or components:

- Defects due to normal wear and tear;
- A given warranty for the Products by any other person or entity than Sonic;
- Defects caused by excessive loading and/or incorrect use and/or improper use and/or careless use of the Product (including usage contrary to instructions), included but not limited to misuse, accident, modification, alternation, unreasonable use, abuse, neglect, use in product related service;
- Defects resulting from modifications or repairs carried out by others than Sonic;
- Defects caused by lack of maintenance and/or poor maintenance and/or use of incorrect cleaning materials. It is essential to refer to the cleaning instructions on the Sonic website when cleaning storage systems;
- Defects resulting from force majeure or any other cause beyond Sonic's control, including but not limited to external violence, natural disasters, fire, floods, lightning, exposure to moisture, etc.;
- Consumables, including Products/parts which are sensitive to usage or wear. Such items include drill bits, saw blades, grinding discs, knife blades, files, scrapers, crowbars, batteries, knives, O2 sensors, etc.

Catalog

Dimensions shown in the Catalog have been rounded to the nearest fractional size or nearest tenth millimeter and are not exact Product specifications.

CONVERSION TABLE FROM INCHES TO MILLIMETRES

CONVERSION EXAMPLE FROM MM TO INCHES: 69,850 MM = 2.3/4"

CONVERSION EXAMPLE FROM INCHES TO MM: 4.1/2" = 114,300 MM

INCHES	MM	MILLIMETRES								
		1	2	3	4	5	6	7	8	9
0	0	25,400	50,800	76,200	101,600	127,000	152,400	177,800	203,200	228,600
1/64	0,397	25,797	51,197	76,597	101,997	127,397	152,797	178,197	203,597	228,997
1/32	0,794	26,194	51,594	76,994	102,394	127,794	153,194	178,594	203,994	229,394
3/64	1,191	26,591	51,991	77,391	102,791	128,191	153,591	178,991	204,391	229,791
1/16	1,588	26,988	52,388	77,788	103,188	128,588	153,988	179,388	204,788	230,188
5/64	1,984	27,384	52,784	78,184	103,584	128,984	154,384	179,784	205,184	230,584
3/32	2,381	27,781	53,181	78,581	103,981	129,381	154,781	180,181	205,581	230,981
7/64	2,778	28,178	53,578	78,978	104,378	129,778	155,178	180,578	205,978	231,378
1/8	3,175	28,575	53,975	79,375	104,775	130,175	155,575	180,975	206,375	231,775
9/64	3,572	28,972	54,372	79,772	105,172	130,572	155,972	181,372	206,772	232,172
5/32	3,969	29,369	54,769	80,169	105,569	130,969	156,369	181,769	207,169	232,569
11/64	4,366	29,766	55,166	80,566	105,966	131,366	156,766	182,166	207,566	232,966
3/16	4,762	30,162	55,562	80,962	106,362	131,762	157,162	182,562	207,962	233,362
13/64	5,159	30,559	55,959	81,359	106,759	132,159	157,559	182,959	208,359	233,759
7/32	5,556	30,956	56,356	81,756	107,156	132,556	157,956	183,356	208,756	234,156
15/64	5,953	31,353	56,753	82,153	107,553	132,953	158,353	183,753	209,153	234,553
1/4	6,35	31,750	57,150	82,550	107,950	133,350	158,750	184,150	209,550	234,950
17/64	6,747	32,147	57,547	82,947	108,347	133,747	159,147	184,547	209,947	235,347
9/32	7,144	32,544	57,944	83,344	108,744	134,144	159,544	184,944	210,344	235,744
19/64	7,541	32,941	58,341	83,741	109,141	134,541	159,941	185,341	210,741	236,141
5/16	7,938	33,338	58,738	84,138	109,538	134,938	160,338	185,738	211,138	236,538
21/64	8,334	33,734	59,134	84,534	109,934	135,334	160,734	186,134	211,534	236,934
11/32	8,731	34,131	59,531	84,931	110,331	135,731	161,131	186,531	211,931	237,331
23/64	9,128	34,528	59,928	85,328	110,728	136,128	161,528	186,928	212,328	237,728
3/8	9,525	34,925	60,325	85,725	111,125	136,525	161,925	187,325	212,725	238,125
25/64	9,922	35,322	60,722	86,122	111,522	136,922	162,322	187,722	213,122	238,522
13/32	10,319	35,719	61,119	86,519	111,919	137,319	162,719	188,119	213,519	238,919
27/64	10,716	36,116	61,516	86,916	112,316	137,716	163,116	188,516	213,916	239,316
7/16	11,112	36,512	61,912	87,312	112,712	138,112	163,512	188,912	214,312	239,712
29/64	11,509	36,909	62,309	87,709	113,109	138,509	163,909	189,309	214,709	240,109
15/32	11,906	37,306	62,706	88,106	113,506	138,906	164,306	189,706	215,106	240,506
31/64	12,303	37,703	63,103	88,503	113,903	139,303	164,703	190,103	215,503	240,903
1/2	12,7	38,100	63,500	88,900	114,300	139,700	165,100	190,500	215,900	241,300
33/64	13,097	38,497	63,897	89,297	114,697	140,097	165,497	190,897	216,297	241,697
17/32	13,494	38,894	64,294	89,694	115,094	140,494	165,894	191,294	216,694	242,094
35/64	13,891	39,291	64,691	90,091	115,491	140,891	166,291	191,691	217,091	242,491
9/16	14,288	39,688	65,088	90,488	115,888	141,288	166,688	192,088	217,488	242,888
37/64	14,684	40,084	65,484	90,884	116,284	141,684	167,084	192,484	217,884	243,284
19/32	15,081	40,481	65,881	91,281	116,681	142,081	167,481	192,881	218,281	243,681
39/64	15,478	40,878	66,278	91,678	117,078	142,478	167,878	193,278	218,678	244,078
5/8	15,875	41,275	66,675	92,075	117,475	142,875	168,275	193,675	219,075	244,475
41/64	16,272	41,672	67,072	92,472	117,872	143,272	168,672	194,072	219,472	244,872
21/32	16,669	42,069	67,469	92,869	118,269	143,669	169,069	194,469	219,869	245,269
43/64	17,066	42,466	67,866	93,266	118,666	144,066	169,466	194,866	220,266	245,666
11/16	17,462	42,862	68,262	93,662	119,062	144,462	169,862	195,262	220,662	246,062
45/64	17,859	43,259	68,659	94,059	119,459	144,859	170,259	195,659	221,059	246,459
23/32	18,256	43,656	69,056	94,456	119,856	145,256	170,656	196,056	221,456	246,856
47/64	18,653	44,053	69,453	94,853	120,253	145,653	171,053	196,453	221,853	247,253
3/4	19,05	44,450	69,850	95,250	120,650	146,050	171,450	196,850	222,250	247,650
49/64	19,447	44,847	70,247	95,647	121,047	146,447	171,847	197,247	222,647	248,047
25/32	19,844	45,244	70,644	96,044	121,444	146,844	172,244	197,644	223,044	248,444
51/64	20,241	45,641	71,041	96,441	121,841	147,241	172,641	198,041	223,441	248,841
13/16	20,638	46,038	71,438	96,838	122,238	147,638	173,038	198,438	223,838	249,238
53/64	21,034	46,434	71,834	97,234	122,634	148,034	173,434	198,834	224,234	249,634
27/32	21,431	46,831	72,231	97,631	123,031	148,431	173,831	199,231	224,631	250,031
55/64	21,828	47,228	72,628	98,028	123,428	148,828	174,228	199,628	225,028	250,428
7/8	22,225	47,625	73,025	98,425	123,825	149,225	174,625	200,025	225,425	250,825
57/64	22,622	48,022	73,422	98,822	124,222	149,622	175,022	200,422	225,822	251,222
29/32	23,019	48,419	73,819	99,219	124,619	150,019	175,419	200,819	226,219	251,619
59/64	23,416	48,816	74,216	99,616	125,016	150,416	175,816	201,216	226,616	252,016
15/16	23,812	49,212	74,612	100,012	125,412	150,812	176,212	201,612	227,012	252,412
61/64	24,209	49,609	75,009	100,409	125,809	151,209	176,609	202,009	227,409	252,809
31/32	24,606	50,006	75,406	100,806	126,206	151,606	177,006	202,406	227,806	253,206
63/64	25,003	50,403	75,803	101,203	126,603	152,003	177,403	202,803	228,203	253,603

CONVERSION TABLES FOR TORQUE WRENCHES

CONVERSION FACTORS

UNIT	SI UNIT			METRIC UNIT		USA/GB UNIT		
	CNM	DNM	NM	CMKG	MKG	FT.LB.	IN.LB.	IN.OZ.
1 CNM	1,0000	0,1000	0,0100	0,1020	0,0010	0,0074	0,0885	1,4161
1 DNM	10,0000	1,0000	0,1000	1,0197	0,0102	0,0738	0,8851	14,1612
1 NM	100,0000	10,0000	1,0000	10,1972	0,1020	0,7376	8,8508	141,6123
1 CMKG	9,8067	0,9807	0,0981	1,0000	0,0100	0,0723	0,8680	13,8874
1 MKG	980,6650	98,0665	9,8067	100,0000	1,0000	7,2330	86,7964	1388,7422
1 FT.LB.	135,5818	13,5581	1,3558	13,8255	0,1383	1,0000	12,0000	192,0000
1 IN.LB.	11,2985	1,1298	0,1130	1,1521	0,0115	0,0833	1,0000	16,0000
1 IN.OZ.	0,7062	0,0706	0,0071	0,0720	0,0007	0,0052	0,0625	1,0000

CONVERSION NM TO MKG						1 NM = 0,10197 MKG				
NM	0	1	2	3	4	5	6	7	8	9
0	0,00	0,10	0,20	0,31	0,41	0,51	0,61	0,71	0,82	0,92
10	1,02	1,12	1,22	1,33	1,43	1,53	1,63	1,73	1,84	1,94
20	2,04	2,14	2,24	2,35	2,45	2,55	2,65	2,75	2,86	2,96
30	3,06	3,16	3,26	3,37	3,47	3,57	3,67	3,77	3,87	3,98
40	4,08	4,18	4,28	4,38	4,49	4,59	4,69	4,79	4,89	5,00
50	5,10	5,20	5,30	5,40	5,51	5,61	5,71	5,81	5,91	6,02
60	6,12	6,22	6,32	6,42	6,53	6,63	6,73	6,83	6,93	7,04
70	7,14	7,24	7,34	7,44	7,55	7,65	7,75	7,85	7,95	8,06
80	8,16	8,26	8,36	8,46	8,57	8,67	8,77	8,87	8,97	9,08
90	9,18	9,28	9,38	9,48	9,59	9,69	9,79	9,89	9,99	10,10
100	10,2	10,3	10,4	10,5	10,6	10,71	10,81	10,91	11,01	11,11

CONVERSION MKG TO NM						1 MKG = 9,80665 NM				
MKG	0	1	2	3	4	5	6	7	8	9
0	0	9,81	19,61	29,42	39,23	49,03	58,84	68,65	78,45	88,26
10	98,07	107,87	117,68	127,49	137,29	147,10	156,91	166,71	176,52	186,33
20	196,13	205,94	215,75	225,55	235,36	245,17	254,97	264,78	274,59	284,39
30	294,2	304,01	313,81	323,62	333,43	343,23	353,04	362,85	372,65	382,46
40	392,27	402,07	411,88	421,69	431,49	441,30	451,11	460,91	470,72	480,53
50	490,33	500,14	509,95	519,75	529,56	539,37	549,17	558,98	568,79	578,59
60	588,4	598,21	608,01	617,82	627,63	637,43	647,24	657,05	666,85	676,66
70	686,47	696,27	706,08	715,89	725,69	735,50	745,31	755,11	764,92	774,73
80	784,53	794,34	804,15	813,95	823,76	833,57	843,37	853,18	862,99	872,79
90	882,6	892,41	902,21	912,02	921,83	931,63	941,44	951,25	961,05	970,86
100	980,67	990,47	1000,28	1010,08	1019,89	1029,70	1039,50	1059,12	1059,12	1068,92

CONVERSION NM TO FT.LB.						1 NM = 0,73756 FT.LB.				
NM	0	1	2	3	4	5	6	7	8	9
0	0,00	0,74	1,48	2,21	2,95	3,69	4,43	5,16	5,90	6,64
10	7,38	8,11	8,85	9,59	10,33	11,06	11,80	12,54	13,28	14,01
20	14,75	15,49	16,23	16,96	17,7	18,44	19,17	19,91	20,65	21,39
30	22,13	22,86	23,60	24,34	25,08	25,81	26,55	27,29	28,03	28,76
40	29,50	30,24	30,98	31,72	32,45	33,19	33,93	34,67	35,40	36,14
50	36,88	37,62	38,35	39,09	39,83	40,57	41,30	42,04	42,78	43,52
60	44,25	44,99	45,73	46,47	47,2	47,94	48,68	49,42	50,15	50,89
70	51,63	52,37	53,10	53,84	54,58	55,32	56,05	56,79	57,53	58,27
80	59,00	59,74	60,48	61,22	61,96	62,69	63,43	64,17	64,91	65,64
90	66,38	67,12	67,86	68,59	69,33	70,07	70,81	71,54	72,28	73,02
100	73,76	74,49	75,23	75,97	76,71	77,44	78,18	78,92	79,66	80,39

CONVERSION FT.LB. TO NM						1 FT.LB. = 1,35581 NM				
FT.LB.	0	1	2	3	4	5	6	7	8	9
0	0,00	1,36	2,71	4,07	5,42	6,78	8,13	9,49	10,85	12,20
10	13,56	14,91	16,27	17,63	18,98	20,34	21,69	23,05	24,40	25,76
20	27,12	28,47	29,83	31,18	32,54	33,90	35,25	36,61	37,96	39,32
30	40,67	42,03	43,39	44,74	46,10	47,45	48,81	50,16	51,52	52,88
40	54,23	55,59	56,94	58,30	59,66	61,01	62,37	63,72	65,08	66,43
50	67,79	69,15	70,50	71,86	73,21	74,57	75,93	77,28	78,64	79,99
60	81,35	82,70	84,06	85,42	86,77	88,13	89,48	90,84	92,20	93,55
70	94,91	96,26	97,62	98,97	100,33	101,69	103,04	104,40	105,75	107,11
80	108,46	109,82	111,18	112,53	113,89	115,24	116,60	117,96	119,31	120,67
90	122,02	123,38	124,73	126,09	127,45	128,80	130,16	131,51	132,87	134,23
100	135,58	136,94	138,29	139,65	141,00	142,36	143,72	145,07	146,43	147,78

CONVERSION IN.LB. TO NM						1 NM = 8,85077 IN.LB.				
Nm	0	1	2	3	4	5	6	7	8	9
0	0,00	8,85	17,70	26,55	35,40	44,25	53,10	61,96	70,81	79,66
10	88,51	97,36	106,21	115,06	123,91	132,76	141,61	150,46	159,31	168,16
20	177,02	185,87	194,72	203,57	212,42	221,27	230,12	238,97	247,82	256,67
30	265,52	274,37	283,22	292,08	300,93	309,78	318,63	327,48	336,33	345,18
40	354,03	362,88	371,73	380,58	389,43	398,28	407,14	415,99	424,84	433,69
50	442,54	451,39	460,24	469,09	477,94	486,79	495,64	504,49	513,34	522,20
60	531,05	539,90	548,75	557,60	566,45	575,30	584,15	593,00	601,85	610,70
70	619,55	628,40	637,26	646,11	654,96	663,81	672,66	681,51	690,36	699,21
80	708,06	716,91	725,76	734,61	743,46	752,32	761,17	770,02	778,87	787,72
90	796,57	805,42	814,27	823,12	831,97	840,82	849,67	858,52	867,38	876,23
100	885,08	893,93	902,78	911,63	920,48	929,33	938,18	947,03	955,88	964,73

CONVERSION NM TO IN.LB.						1 IN.LB. = 0,11298 NM				
in.lb.	0	1	2	3	4	5	6	7	8	9
0	0,00	0,11	0,23	0,34	0,45	0,56	0,68	0,79	0,90	1,02
10	1,13	1,24	1,36	1,47	1,58	1,69	1,81	1,92	2,03	2,15
20	2,26	2,37	2,49	2,60	2,71	2,82	2,94	3,05	3,16	3,28
30	3,39	3,50	3,62	3,73	3,84	3,95	4,07	4,18	4,29	4,41
40	4,52	4,63	4,75	4,86	4,97	5,08	5,20	5,31	5,42	5,54
50	5,65	5,76	5,87	5,99	6,10	6,21	6,33	6,44	6,55	6,67
60	6,78	6,89	7,00	7,12	7,23	7,34	7,46	7,57	7,68	7,80
70	7,91	8,02	8,13	8,25	8,36	8,47	8,59	8,70	8,81	8,93
80	9,04	9,15	9,26	9,38	9,49	9,60	9,72	9,83	9,94	10,06
90	10,17	10,28	10,39	10,51	10,62	10,73	10,85	10,96	11,07	11,19
100	11,30	11,41	11,52	11,64	11,75	11,86	11,98	12,09	12,20	12,31

Index

1		124250055	314	13630	314	1850303	352
100301	202	130001	229	13640	314	1850304	352
100501	180	1310	313	13645	314	1850305	352
100601	180	1311	313	13708	314	1850306	352
100602	187	1311S	313	13710	314	1850308	352
100701	180	1312	313	13715	314	1850310	352
100702	179	1312502	313	13720	314	1850601	352
100704	180	1312S	313	13725	314	1850602	352
100901	179	1313	313	13727	314	1850603	352
100902	179	1314502	313	13730	314	1850604	352
100903	179	1320	313	13740	314	1850605	352
100904	179	1321	313	14423005	315	1850606	352
101001	179	1321S	313	14423006	315	1850607	352
101002	179	1322	313	14423007	315	1850608	352
101003	179	1322S	313	14423008	315	1850609	352
101004	180	1323	313	14423009	315	1850610	352
101005	180	13303	313	14423010	315	18502015	352
101007	186	13304	313	14423011	315	18502025	352
101105	165	13308	313	14423012	315	18503015	352
101201	179	133055S	313	14423013	315	18503025	352
101202	179	133065S	313	15101	313	185020127	352
101203	179	13310	313	15102	313	185030127	352
101204	179	13312	313	1530108	313	1860106	353
101901	187	13325004	313	1530155	313	1860107	353
102801	187	13325055	313	1530165	313	1860108	353
103101	186	13325065	313	1610	313	1860109	353
103201	186	13335	313	1611	313	1860310	353
103202	173	13345065	313	1612	313	1860315	353
103502	165	13355	313	16304	314	1860320	353
104001	165	13365	313	16325	314	1860325	353
104601	188	13360008	313	16355	314	1860327	353
104602	165	1342503	314	16365	314	1860330	353
106105	131	1342504	314	17320002	314	1860340	353
106303	121	1342505	314	48152	245	1860345	353
106304	128	1342506	314	1840302	352	1860350	353
107403	166	13605	314	1840303	352	1861310	353
110001	227	13606	314	1840304	352	1861315	353
110201	121	13607	314	1840305	352	1861320	353
112102	130	13608	314	1840306	352	1861325	353
114101	156	13609	314	1840308	352	1861327	353
114602	147	13610	314	1840310	352	1861330	353
116901	131	13615	314	18403015	352	1861340	353
120001	228	13620	314	18403025	352	1861345	353
12425004	314	13625	314	184030127	352	1861350	353
12425005	314	13627	314	1850202	352	1950202	315
12425006	314	13625015	314	1850203	352	1950203	315
12425008	314	13625020	314	1850204	352	1950204	315
12425009	314	13625025	314	1850205	352	1950205	315
12425010	314	13625027	314	1850206	352	1950206	315
12425011	314	13625030	314	1850208	352	1950207	315
12425012	314	13625040	314	1850210	352	1950208	315
12425013	314	13625045	314	1850302	352	1950210	315

1950212	315	21514	319	2195006	320	2266311	323
19502025	315	21545	319	2195007	320	2266312	323
1960208	315	21555	319	2195008	320	2266314	323
1960210	315	2155004	319	2195009	320	2266316	323
1960215	315	2155005	319	2195010	320	2266318	323
1960220	315	2155006	319	2195011	320	2266320	323
1960225	315	2155007	319	2195012	320	22806	322
1960227	315	2155008	319	2195014	320	22807	322
1960230	315	2155009	319	21950055	320	22808	322
1960240	315	2155010	319	221201	149	22809	322
1960245	315	2155011	319	221801	156	22810	322
1960250	315	2155012	319	221803	157	22811	322
		2155013	319	22506	321	22812	322
		21550045	319	22507	321	22813	322
200801	180	21550055	319	22508	321	22814	322
200802	180	215702	133	22509	321	22815	322
200804	166	21604	320	22510	321	22816	322
200804	403	21605	320	22511	321	22817	322
200805	182	21606	320	22512	321	22818	322
200901	181	21607	320	22513	321	22819	322
200902	181	21608	320	22514	321	22820	322
200903	181	21610	320	22515	321	22821	322
200907	181	216401	148	22516	321	22822	322
201001	180	2165004	320	22517	321	22824	322
201002	181	2165005	320	22518	321	2286306	322
201003	181	2165006	320	22519	321	2286307	322
201005	181	2165007	320	22520	321	2286308	322
201006	181	2165008	320	22521	321	2286309	322
201008	180	2165010	320	22522	321	2286310	322
201009	180	21804	319	22524	321	2286311	322
201010	180	21805	319	2256306	321	2286312	322
201012	181	21806	319	2256307	321	2286313	322
201013	181	21807	319	2256308	321	2286314	322
201014	181	21808	319	2256309	321	2286315	322
201015	182	21809	319	2256310	321	2286316	322
201016	181	21810	319	2256311	321	2286317	322
201201	182	21811	319	2256312	321	2286318	322
201401	122	21812	319	2256313	321	2286319	322
202301	122	21813	319	2256314	321	2286320	322
202302	128	21845	319	2256315	321	2286321	322
202803	166	21855	319	2256316	321	2286322	322
203001	122	218502	149	2256317	321	2286324	322
203703	167	2185004	319	2256318	321	22906	322
204003	167	2185005	319	2256319	321	22908	322
204101	122	2185006	319	2256320	321	22910	322
204102	128	2185007	319	2256321	321	22911	322
205301	173	2185008	319	2256322	321	22913	322
206102	167	2185009	319	22604	323	22914	322
206501	132	2185010	319	22605	323	22916	322
207601	168	2185011	319	22606	323	22917	322
208001	122	2185012	319	22607	323	22919	322
213001	148	2185013	319	22608	323	22921	322
214301	132	21850045	319	22610	323	22922	322
214702	133	21850055	319	22611	323	2296306	323
21503	319	21905	320	22612	323	2296308	323
21504	319	21906	320	22614	323	2296310	323
21505	319	21907	320	22616	323	2296311	323
21506	319	21908	320	22618	323	2296313	323
21507	319	21909	320	22620	323	2296314	323
21508	319	21910	320	2266304	323	2296316	323
21509	319	21911	320	2266305	323	2296317	323
21510	319	21913	320	2266306	323	2296319	323
21511	319	21914	320	2266307	323	2296321	323
21512	319	21955	320	2266308	323	2296322	323
21513	319	2195005	320	2266310	323	23508	324

Index

23509	324	23808	325	2397713	326	25858	328
23510	324	23809	325	2397714	326	25860	328
23511	324	23810	325	2397716	326	25863	328
23512	324	23811	325	2397717	326	25865	328
23513	324	23812	325	2397719	326	25867	328
23514	324	23813	325	2397721	326	25870	328
23515	324	23814	325	2397722	326	25871	328
23516	324	23815	325	2397724	326	25875	328
23517	324	23816	325	2397725	326	25877	328
23518	324	23817	325	2397727	326	25880	328
23519	324	23818	325	2397729	326		
23520	324	23819	325	2397730	326	3	
23521	324	23820	325	2397732	326	300301	200
23522	324	23821	325	24819	328	300302	200
23523	324	23822	325	24822	328	300303	201
23524	324	23823	325	24824	328	300304	200
23525	324	23824	325	24825	328	300308	183
23526	324	23825	325	24827	328	300310	200
23527	324	23826	325	24829	328	300311	200
23528	324	23827	325	24830	328	300312	200
23529	324	23828	325	24832	328	300313	377
23530	324	23829	325	24833	328	300401	199
23532	324	23830	325	24835	328	300504	201
2357708	325	23832	325	24836	328	300506	200
2357709	325	2387708	326	24838	328	300507	200
2357710	325	2387709	326	24841	328	300601	190
2357711	325	2387710	326	24842	328	300603	189
2357712	325	2387711	326	24844	328	300605	189
2357713	325	2387712	326	24846	328	300608	122
2357714	325	2387713	326	24847	328	300814	183
2357715	325	2387714	326	24850	328	300816	168
2357716	325	2387715	326	24917	327	300817	168
2357717	325	2387716	326	24918	327	300818	168
2357718	325	2387717	326	24919	327	300819	168
2357719	325	2387718	326	24920	327	300820	169
2357720	325	2387719	326	24921	327	300821	169
2357721	325	2387720	326	24922	327	300822	169
2357722	325	2387721	326	24923	327	300823	169
2357723	325	2387722	326	24924	327	300901	201
2357724	325	2387723	326	24925	327	300902	182
2357725	325	2387724	326	24926	327	300903	182
2357726	325	2387725	326	24927	327	300906	183
2357727	325	2387726	326	24928	327	300908	123
2357728	325	2387727	326	24929	327	300910	190
2357729	325	2387728	326	24930	327	301002	183
2357730	325	2387729	326	24932	327	301003	183
2357732	325	2387730	326	24933	327	301005	183
23610	327	2387732	326	24934	327	301006	183
23611	327	23910	326	24935	327	301007	182
23612	327	23911	326	24936	327	301008	183
23614	327	23913	326	24938	327	301201	182
23616	327	23914	326	24941	327	301202	182
23618	327	23916	326	24942	327	301203	182
23620	327	23917	326	24946	327	301204	182
23622	327	23919	326	24950	327	301302	211
23624	327	23921	326	24955	327	301503	182
2367710	327	23922	326	24960	327	301504	182
2367711	327	23924	326	25835	328	301601	189
2367712	327	23925	326	25836	328	301603	123
2367714	327	23927	326	25838	328	301702	169
2367716	327	23929	326	25841	328	301904	169
2367718	327	23930	326	25846	328	302001	203
2367720	327	23932	326	25850	328	302003	123
2367722	327	2397710	326	25854	328	302004	128
2367724	327	2397711	326	25855	328	302005	128

302104	124	3256321	330	3358518	331	34547	332
302204	123	3256322	330	3358519	331	34548	332
302301	123	3310115	328	3358520	331	34550	332
302404	170	3310117	328	3358521	331	34552	332
302801	173	3310119	328	3358522	331	34554	332
303401	173	3310121	328	3358523	331	34555	332
303805	123	3310122	328	3358524	331	34557	332
303806	128	3310217	329	3358525	331	34558	332
303902	137	3310219	329	3358526	331	34559	332
304201	189	3310221	329	3358527	331	34560	332
304501	170	3310317	329	3358528	331	34563	332
305002	132	3310319	329	3358529	331	34565	332
305605	123	3310321	329	3358530	331	34570	332
306402	137	3310322	329	3358532	331	3459017	333
306701	170	3310517	329	3358533	331	3459018	333
307302	137	3310519	329	3358534	331	3459019	333
307603	171	3310521	329	3358535	331	3459020	333
308201	150	3310617	330	3358536	331	3459021	333
308401	151	3310715	329	3358538	331	3459022	333
308502	174	3310717	329	3367810	332	3459023	333
309101	171	3310719	329	3367811	332	3459024	333
309301	145	3310721	329	3367812	332	3459025	333
309302	137	3310722	329	3367814	332	3459026	333
309402	172	3310817	329	3367816	332	3459027	333
309502	134	3310819	329	3367818	332	3459028	333
309507	135	3310821	329	3367820	332	3459029	333
309901	172	33508	330	3367822	332	3459030	333
310001	145	33509	330	3367824	332	3459032	333
310101	134	33510	330	3397824	331	3459033	333
310501	135	33511	330	3397827	331	3459034	333
311201	136	33512	330	3397834	331	3459035	333
311501	158	33513	330	3397835	331	3459036	333
311801	150	33514	330	3398530	331	3459038	333
313902	136	33515	330	3398532	331	3459039	333
314901	157	33516	330	3398534	331	3459040	333
315601	151	33517	330	3398535	331	3459041	333
316001	134	33518	330	3398536	331	3459042	333
32508	329	33519	330	34517	332	3459043	333
32509	329	33520	330	34518	332	3459044	333
32510	329	33521	330	34519	332	3459045	333
32511	329	33522	330	34520	332	3459046	333
32512	329	33523	330	34521	332	3459047	333
32513	329	33524	330	34522	332	3459048	333
32514	329	33525	330	34523	332	3459050	333
32515	329	33526	330	34524	332	3459052	333
32516	329	33527	330	34525	332	3459054	333
32517	329	33528	330	34526	332	3459055	333
32518	329	33529	330	34527	332	3469018	333
32519	329	33530	330	34528	332	3469020	333
32520	329	33532	330	34529	332	3469024	333
32521	329	33533	330	34530	332	3499017	333
32522	329	33534	330	34532	332	3499019	333
3256308	330	33535	330	34533	332	35524	334
3256309	330	33536	330	34534	332	35525	334
3256310	330	33538	330	34535	332	35526	334
3256311	330	3358508	331	34536	332	35527	334
3256312	330	3358509	331	34538	332	35528	334
3256313	330	3358510	331	34539	332	35530	334
3256314	330	3358511	331	34540	332	35532	334
3256315	330	3358512	331	34541	332	35533	334
3256316	330	3358513	331	34542	332	35534	334
3256317	330	3358514	331	34543	332	35535	334
3256318	330	3358515	331	34544	332	35536	334
3256319	330	3358516	331	34545	332	35538	334
3256320	330	3358517	331	34546	332	35540	334

Index

35541	334	3559085	334	4143032	341	41546	342
35542	334	3559090	334	4143436	341	41548	342
35543	334	3559095	334	41506	342	41550	342
35544	334	3559065	334	41507	342	41555	342
35545	334	3559066	334	41508	342	41558	342
35546	334			41509	342	41560	342
35548	334	4		4150206	342	41565	342
35550	334	402001	188	4150208	342	41570	342
35551	334	403201	138	4150210	342	41575	342
35552	334	403301	138	4150211	342	41580	342
35553	334	40808	340	4150213	342	41585	342
35554	334	40809	340	4150214	342	4160608	345
35555	334	4080809	340	4150216	342	4160711	345
35557	334	40810	340	4150217	342	4161012	345
35558	334	40811	340	4150219	342	4161418	345
35559	334	40812	340	4150221	342	4161622	345
35560	334	4081011	340	4150222	342	4162024	345
35563	334	4081213	340	4150224	342	41706	341
35565	334	4110810	340	4150225	342	41707	341
35566	334	4111113	340	4150227	342	41708	341
35568	334	4111214	340	4150228	342	41709	341
35570	334	4111618	340	4150232	342	4170108	343
35571	334	4111719	340	4150233	342	4170109	343
35575	334	4111922	340	4150235	342	4170110	343
35580	334	4112427	340	4150238	342	4170111	343
35585	334	4113032	340	4150241	342	4170112	343
35590	334	41201	341	4150310	342	4170113	343
35595	334	41202	341	4150311	342	4170114	343
3559024	334	4120607	340	4150312	342	4170115	343
3559025	334	4120809	340	4150313	342	4170116	343
3559026	334	4121011	340	4150314	342	4170117	343
3559027	334	4121213	340	4150315	342	4170118	343
3559028	334	4121415	340	4150316	342	4170119	343
3559030	334	4121617	340	4150317	342	4170208	343
3559032	334	4121819	340	4150318	342	4170209	343
3559033	334	41210608	340	4150319	342	4170210	343
3559034	334	41211012	340	41510	342	4170211	343
3559035	334	41211418	340	41511	342	4170212	343
3559036	334	41212024	340	41512	342	4170213	343
3559038	334	4122022	340	41513	342	4170214	343
3559040	334	4122123	340	41514	342	4170215	343
3559041	334	4122427	340	41515	342	4170216	343
3559042	334	41308	345	41516	342	4170217	343
3559043	334	41310	345	41517	342	4170218	343
3559044	334	41311	345	41518	342	4170219	343
3559045	334	41312	345	41519	342	4170221	343
3559046	334	41313	345	41520	342	4170222	343
3559048	334	41314	345	41521	342	4170224	343
3559050	334	41315	345	41522	342	4170227	343
3559051	334	41316	345	41523	342	4170308	343
3559052	334	41317	345	41524	342	4170309	343
3559053	334	41318	345	41525	342	4170310	343
3559054	334	41319	345	41526	342	4170311	343
3559055	334	4140607	341	41527	342	4170312	343
3559057	334	4140809	341	41528	342	4170313	343
3559058	334	4141011	341	41529	342	4170314	343
3559059	334	4141213	341	41530	342	4170315	343
3559060	334	4141415	341	41532	342	4170316	343
3559063	334	4141617	341	41533	342	4170317	343
3559068	334	4141819	341	41534	342	4170318	343
3559070	334	4142022	341	41535	342	4170319	343
3559071	334	4142123	341	41536	342	4170401	344
3559075	334	4142224	341	41538	342	4170402	344
3559076	334	4142427	341	41541	342	41710	341
3559080	334	4142528	341	41543	342	41711	341

41712	341	4222932	341	4381225	360	4611400	365
41713	341	42301150	345	4382125	360	4620400	365
41714	341	42301200	345	4382175	360	4621000	365
41715	341	42301250	345	4382250	360	4631000	365
41716	341	42301300	345	4383175	360	4640500	365
41717	341	42301375	345	4383250	360	4640600	365
41718	341	4250608	340	4384250	360	4640800	365
41719	341	4251011	340	4385150	360	4641500	365
41720	341	4251314	340	4385275	360	4642000	365
41721	341	4251617	340	4386150	360	4652035	365
41722	341	42608	343	4386275	360	4652060	365
41723	341	42609	343	4387250	360	46601	365
41724	341	42610	343	4388275	360	46602	365
41725	341	42611	343	4391175	360	46603	365
41726	341	42612	343	4393001	359	46701	365
41727	341	42613	343	4393002	359	46702	365
41728	341	42614	343	4393003	359	46703	365
41729	341	42615	343	4393004	359	46704	365
41730	341	42616	343	4393005	359	46804	366
41732	341	42617	343	4393006	359	46806	366
41760608	344	4270608	344	4393007	359	46807	366
41761012	344	4271011	344	4410265	361	46806-1	366
41761418	344	4271314	344	4411001	221	46807-1	366
41762024	344	4271416	344	4411002	221	46905	366
4180607	344	4271719	344	4411003	221	46911	366
4180809	344	4272122	344	4450250	361	46912	366
4181011	344	4272425	344	4450300	361	46913	366
4181213	344	4311165	357	44601280	358	46914	366
4181415	344	4311175	357	4471180	358	47002	367
4181617	344	4312180	357	4471250	358	47003	367
4181819	344	4312200	357	4472100	198	47004	367
4182123	344	4321160	357	4472160	358	47005	367
4190607	344	4321170	357	4473001	361	47006	367
4190809	344	4321200	357	4473002	361	47008	367
4191011	344	4322160	357	4473003	361	47010	367
4191213	344	4322200	357	4473004	361	47013	367
4191415	344	4323275	359	4473005	361	47016	314
4191617	344	4324115	359	4474001	361	47017	220
4191819	344	4325115	359	4474002	361	47018	220
4192022	344	4331200	357	4476001	360	47019	220
4192122	344	4333270	359	4476002	360	47022	220
4192123	344	4333275	359	4476004	359	47023	206
4192326	344	4341145	357	4476005	359	47024	367
4192427	344	4341175	357	4476006	359	47025	219
4192528	344	4341180	357	4476007	359	47028	367
4193032	344	4341190	357	45110141	363	47031	221
4193436	344	4342160	358	45112160	363	47032	367
4200113	345	4342200	358	45116170	363	47033	361
4200607	345	4342240	358	45118190	363	47035	220
4200809	345	4343200	358	45124220	363	47036	220
4201011	345	4344115	359	4527190	363	47034340	361
4201213	345	4345115	359	4532140	363	47034550	361
4201415	345	4351180	358	4533150	363	47034680	361
4201617	345	4351250	358	4534180	363	47204	56
4201819	345	4351300	358	4535200	363	47206	57
4211012	345	4351400	358	4536210	363	47209	58
4211113	345	4352180	358	4538220	363	4720101	52
4211417	345	4352250	358	4552185	363	4720102	52
4220608	341	4352400	358	4553185	363	4720103	52
4221011	341	43611	359	4554185	363	4720104	52
4221314	341	43612	359	45602	363	4720105	52
4221617	341	43613	359	4560201	194	4720106	52
4221719	341	43614	359	4560202	194	4720107	52
4222122	341	4380250	360	4564185	363	4720108	52
4222425	341	4381150	360	4611200	365	4720109	52

Index

4720110	52	4730928	16	47401	212	47523	61
4720111	52	4730938	16	47402	212	47534	308
4720112	52	4730948	16	47403	212	47535	308
4720114	52	47307118	23	47404	212	47536	315
4720115	52	47308113	22	47410	57	47537	315
4720116	52	47310	63	47411	57	47538	315
4720117	52	47318	60	47412	57	4753701	315
47209F	58	47319	60	47414	61	47541	63
47209S	58	4731118	18	47415	51	47543	63
47210	63	4731128	18	47416	51	47544	51
47211	55	4731138	18	47417	51	47545	51
47213	54	4731148	18	47418	51	47546	61
47214	63	4731196	44	47419	51	47547	61
47215	59	4731230	44	47420	51	47548	54
47216	59	4731281	44	47421	51	47549	55
47230	55	47320	60	47431	46	47550	60
47242	213	47321	60	47432	46	47551	55
47243	59	47322	57	47433	50	47553	60
47244	59	47328	59	47434	63	47561	58
47251	55	47329	59	47439	62	47570	213
47252	55	4732013	27	47447	51	47571	213
47253	60	4732110	27	47448	51	47572	55
47254	60	4732418	14	47449	51	47573	58
47257	55	4732718	19	47450	46	47573F	58
47258	57	47334	56	47451	47	47573S	58
47259	57	47337	60	47452	62	47580	54
47262	54	47338	60	47453	63	47581	54
47264	57	47339	60	47454	63	47600	50
47265	60, 61	4733014	28	47460	63	47601	55
47266	60, 61	4733115	17	47461	62	47602	61
47267	56	4733716	12	47462	62	47603	61
47272	50	47338114	24	47463	63	47604	61
47273	57	47340	60	47464	62	47605	57
47275	63	47343	56	47465	62	47606	54
47276	50	47346	56	47466	62	47607	60
47279	51	47347	56	47467	62	47608	60
47280	45	47348	57	47468	62	47609	56
47281	61	4734218	20	47474	63	47610	60
47282	61	47350	57	47475	62	47612	146
47283	51	47353	56	47476	62	47613	127
47284	51	47364	54	47477	62	47614	54
47287	63	47365	60	47478	62	47615	54
47288	45	47366	60	47479	62	47622	63
47289	63	47367	63	47480	62	47623	63
47290	51	47368	57	47481	62	47624	63
47291	51	47369	56	47482	62	47625	63
47292	50	47374	54	47491	61	47630	61
47295	51	47376	51	47494	58	47631	58
47296	50	47377	51	47498	54	47632	51
47297	61	47378	51	47499	54	47637	61
47298	61	47379	50	47494B	58	47638	52
47302	50	47380	51	47494S	58	47639	52
47303	63	47381	51	47502	29, 104	47631F	58
47306	51	47382	51	47503	29, 105	47631S	58
47308	46	47383	51	47505	50	47640	45
47309	155	47384	51	47513	61	47641	61
4730167	13	47385	51	47514	61	47642	61
4730196	44	47386	63	47515	61	47643	57
4730224	28	47389	63	47516	61	47644	56
4730230	44	47391	60	47517	60	47645	61
4730281	44	47392	60	47518	60	47646	61
4730414	28	47393	60	47519	56	47647	45
4730415	28	47394	60	47520	57	47649	47
4730434	28	47395	57	47521	57	47650	50
4730918	16	47396	60	47522	55	47651	62

47652	62	47909	369	4811241	247	4821511	52, 219
47666	58	47910	369	4811242	247	4821512	52, 219
47667	58	47911	369	4811243	247	4821513	219
47671	59	47912	369	4811244	247	4821514	52, 219
47672	59	4800701	233	4811245	247	4821515	52, 219
47686	60	4800702	233	4811254	366	4821516	219
47687	60	4800703	233	4811256	251	4821517	52, 219
47688	60	4800704	233	4811257	251	4821518	52
47689	60	4800705	233	4811258	251	4821519	52
47690	60	4800706	233	4811260	367	4821701	219
47691	60	4800707	233	4811263	251	4821702	219
47692	60	4800708	233	4811264	247	4821703	219
47693	60	48025	233	48120	250	4821901	213
47694	60	48031	232	48121	250	4821902	213
47695	61	48032	232	48122	250	48212380	195
47722	55	48033	232	48123	250	48212530	195
47723	54	48034	232	48124	250	48212650	195
47724	25	48035	232	48125	250	4822102	198, 365
47725	25	48104	213	48126	213	4822301	222
47726	25	48105	213	48127	250	4822302	222
47727	25	48108	245	48128	250	4822303	222
47728	25	48109	245	48129	250	4822304	222
47729	25	48110	245	48130	250	4822305	222
47730	25	48111	245	48132	245	4822306	222
47733	59	48112	214	48149	245	4822307	222
47734	59	48114	250	48148-1	247	4822308	222
47750	61	48115	250	48148-2	247	4822309	222
47751	54	48116	250	48150	245	4822310	222
47772	53	48117	250	48151	245	4822311	222
47790	308	48118	250	4820106	370	4822312	222
47791	308	48119	250	4820110	370	4822313	223
47792	308	4811205	247	4820111	370	4822314	223
47795	308	4811206	247	4820201	369	4822315	223
47796	308	4811207	247	4820207	370	4822316	223
47797	308	4811208	247	4820513	241	4822317	223
47798	308	4811209	247	4820515	239	4822318	223
47799	106	4811210	247	4820516	238	4822319	223
47814	369	4811213	247	4820517	238	4822320	223
47815	216	4811214	247	4820518	239	4822321	223
47816	216	4811215	247	4820519	237	4822322	223
47817	368	4811216	247	4820520	237	4822323	223
47818	368	4811217	247	4820523	240	4822324	223
47819	368	4811218	247	4820524	51, 53	4822325	224
47820	368	4811219	247	4820537	53	4822326	224
47824	366	4811220	247	4820538	53	4822327	224
47825	368	4811221	247	4820539	53	4822328	224
47826	205	4811222	247	4820540	53	4822329	224
47827	205	4811223	247	4820541	53	4822330	224
47828	315, 403	4811224	247	4820542	53	4822331	233
47829	369	4811225	247	48203210	370	4822332	219
47830	369	4811226	247	48203300	370	4822333	224
47831	369	4811227	247	48203460	370	4822334	224
47832	369	4811228	247	48203610	370	4822335	224
47837	314	4811229	247	4821102	241	4822336	224
47838	314	4811230	247	4821105	241	4822337	224
47839	314	4811231	247	4821106	241	4822338	224
47840	314	4811232	247	4821301	196	4822339	225
47901	368	4811233	247	4821302	196	4822340	225
47902	368	4811234	247	4821303	196	4822341	225
47903	368	4811235	247	4821304	196	4822342	225
47904	368	4811236	247	4821305	196	4822343	225
47905	368	4811237	247	4821308	370	4822344	225
47906	368	4811238	247	4821312	370	4822345	225
47907	368	4811239	247	4821318	370	4822346	225
47908	369	4811240	247	4821324	370	4822347	225

Index

4822348	225	5089008	35	5999401	35	5999933	35
4822349	226	5089009	34	5999402	35	5999934	34
4822350	226	5089010	35	5999403	35	5999935	34
4822351	226	5089011	34	5999404	35	5999936	35
4822352	226	5089012	35	5999405	35	5999937	34, 35
4822353	226	5089013	35	5999406	35	5999938	34
4822354	226	5089015	34	5999407	35		
4822355	226	5096501	35	5999408	35	6	
4822356	226	5106001	35	5999501	35	600203	191
4822401	235	5106002	34	5999601	35	600308	198
4822402	235	5153901	34	5999602	35	600318	196
4822403	235	5660001	39	5999603	35	600319	126
4822404	235	5770001	38	5999604	35	600320	194
4822405	235	5770002	38	5999701	35	600402	191
4822406	235	5770003	38	5999702	35	600403	195
4822407	235	5770004	38	5999703	35	600430	126
4822408	235	5770005	38	5999704	35	600432	126
4822409	235	5770006	38	5999705	35	600434	126
4822410	235	5771101	38	5999706	35	600435	125
4822411	235	5771102	38	5999707	35	600436	195
4822503	365	5771103	38	5999708	35	600437	194
4822505	367	5771104	38	5999709	35	600439	194
4830703	212	5771105	38	5999710	35	600506	196
4830704	212	5771106	38	5999711	35	600507	191
4830706	212	5771107	38	5999712	35	600512	185
4830801	206	5880001	39	5999801	35	600513	120
4830802	206	5880002	39	5999802	35	600514	185
4831101	363	5880003	39	5999803	35	600614	127
4831201	199	5880004	39	5999804	35	600618	185
4831302	206	5880005	39	5999805	35	600619	185
487001	214	5881101	39	5999806	35	600620	185
487002	214	5881102	39	5999807	35	600621	349
		5881103	39	5999808	35	600622	351
5		5881104	39	5999809	35	600623	127
501401	188	5881105	39	5999902	34	600624	363
5036001	34	5881106	38	5999903	34	600625	120
5036002	34	5999021	35	5999904	34	600626	120
5036003	34	5999043	35	5999905	34	600627	120
5065501	35	5999044	35	5999906	34	600701	191
5065502	35	5999045	35	5999907	34	600705	127
5070001	35	5999061	37	5999908	34	600708	124
5071801	34	5999201	37	5999909	34	600709	125
5071802	34	5999202	37	5999910	34	600712	349
5072001	34	5999204	37	5999911	34	600713	349
5072002	34	5999205	37	5999912	34	600716	349
5072003	35	5999206	37	5999913	34	600717	120
5072004	34	5999208	37	5999914	34	600718	121
5072005	34	5999301	37, 53	5999915	34	600719	121
5072006	35	5999302	37, 53	5999916	34	600806	190
5072007	34	5999304	37	5999917	34	600813	351
5072008	35	5999305	36	5999918	34	600822	127
5072009	34	5999306	36	5999919	34	600823	120
5072010	34	5999307	36	5999920	34	600824	120
5072011	34	5999308	36	5999921	34	600825	126
5072012	34	5999309	36	5999922	35	600826	120
5072015	35	5999310	36	5999923	35	600830	350
5072018	34	5999311	36	5999924	35	600831	349
5082001	34	5999312	36	5999925	35	600902	351
5089001	34	5999313	36	5999926	35	600907	388
5089002	34	5999314	36	5999927	35	600908	388
5089003	35	5999315	36	5999928	35	600909	351
5089004	34	5999316	36	5999929	35	600912	350
5089005	34	5999317	36	5999930	34	600913	121
5089006	35	5999318	36	5999931	34	600914	121
5089007	34	5999319	36	5999932	34	600919	186

600923	350	602709	129	7110203P	376	7144100	379
600924	351	602710	154	7110301P	377	7144200	379
600925	349	602712	145	7110302P	377	7145200	379
600926	351	602716	129	711201	106	7145400	379
600927	349	602803	155	7120101	375	7150108	400
600928	144	602904	131	7120102	375	7150110	400
600931	350	603002	138	7120301	376	7150216	331
601001	186	603003	138	7120302	376	7150217	331
601003	350	603004	125	7120303	376	7150218	331
601006	315, 350	603101	145	7120701	375	7150219	331
601007	349	603202	147	7120702	375	7150310	199
601008	350	603207	147	7120703	375	71511	380
601014	194	603209	159	7120704	377	7151604	321
601015	194	603402	158	7120901	375	7151605	321
601016	124	603506	129	7120902	375	7151606	321
601017	124	603701	138	7120903	375	7151607	321
601020	188	603903	139	7120301P	376	7151608	321
601103	124	604001	154	7120302P	376	7151806	320
601105	388	604002	138	7120303P	376	7151807	320
601106	388	604102	129	7120701P	375	7151808	320
601204	190	604202	155	7120702P	375	7151809	320
601207	141	604207	141	7120703P	375	7151810	320
601218	191	604302	146	7120704P	377	7151811	320
601219	191	604402	144	7120902P	375	7151812	320
601225	125	604501	159	7120903P	375	7151813	320
601227	126	604702	139	7121101	375	71511P	380
601228	124	604801	152	7121102	375	71521	380
601229	124	604901	139	7121103	375	7152450	379
601230	125	605001	139	7121204	377	7152610	324
601305	350	605003	188	7121205	377	7152612	324
601306	350	605101	151	7121305	377	7152614	324
601307	351	605301	151	7121403	377	7152616	324
601401	190	605304	139	7121501	375	7152810	323
601404	140	606302	160	7121502	375	7152811	323
601406	128	606601	160	7121503	375	7152812	323
601503	186	606901	152	7121204P	377	7152813	323
601601	142	607201	159	7121205P	377	7152814	323
601606	142			7121501P	375	7152815	323
601702	190	7		7121502P	375	7152816	323
601706	143	704721	108	7121503P	375	7152817	323
601707	140	706201	109	7131115	379	7152818	323
601802	141	708401	106	713201	104	7152819	323
601806	144	708971	108	713202	105	71521P	380
601808	130	709404	303	7132165	379	71531	380
601903	124	709601	108	7133250	379	7153618	327
601904	124	7110101	376	7134450	379	7153620	327
601906	187	7110102	376	7135	381	7153622	327
601907	146	7110201	376	7135550	379	7153624	327
601908	353	7110202	376	7135560	379	71531P	380
602006	185	7110203	376	713840	67	71623	381
602007	143	7110301	377	714040	67	71632	381
602103	142	7110302	377	7141050	379	716931	82
602104	144	7110303	377	7141100	379	717109	82
602105	144	7110402	376	7141150	379	717115	83
602204	152	7110403	376	7141250	379	717116	83
602205	125	7110801	376	7142044	379	717119	83
602209	140	7110802	376	7142075	379	7171216	335
602302	140	7110803	376	7142150	379	7171218	335
602303	186	711013300	376	7142200	379	7171221	335
602308	153	711013440	376	7142250	379	7171316	335
602407	130	7110101P	376	7142300	379	7171318	335
602411	155	7110102P	376	7142450	379	7171321	335
602603	190	711013P	376	7142600	379	7172214	335
602605	153	7110201P	376	7143125	379	7172216	335
602708	129	7110202P	376	7143250	379	7172218	335

Index

7172221	335	726209	71	73251000	387	746019	78
7172316	335	726215	71	7325P	387	747109	79
7172318	335	726216	71	733809	73	747115	79
7172321	335	726219	71	733815	73	747116	79
717331	70	726231	71	733816	73	747119	79
7174214	335	7262044	379	733819	73	747131	79
7175214	335	7262075	379	733831	73	748512	86
7176208	324	7262150	379	7342075	380	748517	86
7176209	324	7262200	379	7343075	380	748518	86
7176210	324	7262250	379	7343125	380	748520	86
7176212	324	7262300	379	7343250	380	748529	86
7176214	324	7262450	379	7344150	380	75104DE	403
7176216	324	726329	84	7344250	380	75104ENG	403
7183075	380	726331	111	7344400	380	75105DE	403
7183125	380	7263050	379	734511	84	75105ENG	403
7183250	380	7263125	379	734517	84	75105FR	403
7184400	380	7263250	379	734518	84	75105IT	403
71912	381	7263500	379	734520	84	75105NL	403
71921	381	7271150	378	734529	84	75115	403
71923	381	7271P	378	7345150	380	751502XL	404
71932	381	7272200	378	7345175	380	75150L	404
71934	381	7272250	378	7345250	380	75150M	404
71943	381	7273250	378	7345400	380	75150S	404
72011	381	7273380	378	734931	75	75150XL	404
7201001	382	727709	71	73521	381	75166	403
72023	381	727715	71	735231	83	75185	403
7202001	382	727716	71	73531	381	75186	403
72032	381	727719	71	73541	381	75187	403
72033	381	727731	71	735709	83	75188	403
720606	68	728406	68	735715	83	75189	403
720628	103	728528	103	735716	83	75192	403
720634	103	728534	103	735719	83	75194	403
7211	380	728907	94	73612	381	75195	403
72225	382	730209	72	73621	381	75196	404
7232200	378	730215	72	73623	381	75197	404
7232250	378	730216	72	73632	381	75198	404
7232P	378	730219	72	73634	381	75199	404
7233250	378	730231	72	73643	381	75200	404
7233380	378	73021050	387	73645	381	75201	404
7233600	378	730220100	387	736909	74	75202	404
7233601	378	7302P	387	736915	74	75203	404
7233602	378	730320100	387	736916	74	75204	404
7233605	378	730340200	387	736919	74	75208L	404
7233P	378	730360300	387	736931	74	75208M	404
7234500	378	730380400	387	73721	382	75208XL	404
7234600	378	7303P	387	737404	306	75208XXL	404
723931	70	7304110550	387	739009	76	75209L	404
72401	378	7304150750	387	739015	76	75209M	404
72402	378	7304P	387	739016	76	75209XL	404
72403	379	73210525	387	739119	76	75209XXL	404
724006	68	73210525P	387	739131	76	75214	187
724704	304	73220550	387	740011	85	75210L	404
725109	71	732210100	387	740017	85	75210M	404
725115	71	7322P	387	740018	85	75210XL	404
725116	71	732310100	387	740020	85	75210XXL	404
725119	71	732320200	387	740029	85	752709	80
725131	71	732360300	387	742009	77	752715	80
725306	69	732380400	387	742015	77	752716	80
72601	379	7323P	387	742016	77	752719	80
72602	379	7324750	387	742019	77	752731	80
72603	379	73241000	387	742031	77	753308	87
726131	70	7324550	387	745446	112	753311	87
7261050	379	7324550P	387	746009	78	753317	87
7261100	379	7324750P	387	746015	78	753318	87
7261250	379	7325750	387	746016	78	753320	87

753329	87	8103704	393	815002	214	8183710	394
753909	81	8103705	393	8153708	394	819001	217
753915	81	8103706	393	8153710	394	819002	217
753916	81	8103707	393	8153715	394	819005	215
753919	81	8103708	393	8153720	394	819008	219
753931	81	8103709	393	8153725	394	819009	216
754007	95	8103710	393	8153727	394	8193704	394
757508	88	81037055	393	8153730	394	8193705	394
757511	88	811002	207	8153740	394	8193706	394
757517	88	811003	206	8153745	394	8193707	394
757518	88	811003-27	206	8153750	394	8193708	394
757520	88	811003-32	206	816001	210	8193710	394
757529	88	811003-36	206	81613710	394	820006	217
757544	88	8113700	393	81613715	394	820007	210
760508	90	8113701	393	81613720	394	820014	201
760544	90	8113702	393	81613725	394	820015	201
760546	90	8113703	393	81613727	394	820016	201
764408	89	812001	211	81613730	394	820017	210
764411	89	812002	199	81613740	394	820018	212
764417	89	812003	205	8163706	393	820019	212
764418	89	812006	210	8163707	393	8209003	395
764420	89	812007	206	8163708	393	8209004	395
764429	89	812008	206	8163709	393	8209005	395
771408	91	8123700	393	8163710	393	8209006	395
771444	91	8123701	393	8163715	393	8209007	395
771446	91	8123702	393	8163720	393	8209008	395
772346	93	8123703	393	8163725	393	8209009	395
773508	92	81302	197	8163727	393	8209010	395
773544	92	81303	197	8163730	393	82090055	395
773546	92	81304	197	8163740	393	821001	196
795808	97	81305	197	817006	204	8214801	394
795844	97	81306	197	817007	204	8214802	394
		81307	197	8173706	394	8214803	394
8		81308	197	8173707	394	822001	205
801003	207	81309	197	8173708	394	822002	205
801016	208	813001	197	8173709	394	8224801	394
801018	208	813002	197	8173710	394	8224802	394
801206	202	813003	358	8173715	394	8224803	394
801305	202	81310	197	8173720	394	8234806	395
802214	203	81311	197	8173725	394	8234807	395
803001	194	81315	197	8173727	394	8234808	395
803003	206	81316	197	8173730	394	82348055	395
803004	195	81317	197	8173740	394	82414803	395
803005	195	8133704	393	818001	214	82414804	395
805001	199	81337055	393	818002	214	82414805	395
805002	209	81337065	393	818003	214	82414806	395
805003	195	814001	211	818004	215	82414808	395
805007	218	814002	211	818007	204	82414810	395
805010	208	81413703	393	818008	214	82414812	395
805011	208	81413704	393	818009	215	82414813	395
805012	215	81413705	393	818010	215	824148055	395
805015	199	81413706	393	818011	215	8244803	395
805017	217	81413707	393	818014	216	8244804	395
805018	210	81413708	393	818015	216	8244805	395
805019	330	81413710	393	818016	216	8244806	395
806001	204	8143703	393	818017	216	8244807	395
807001	190	8143704	393	818021	217	8244808	395
808001	211	8143705	393	818023	218	8244809	395
809007	209	8143706	393	818025	218	8244810	395
810002	198	8143707	393	818026	201	8244811	395
810003	205	8143708	393	818028	217	8244812	395
810004	205	8143709	393	8183704	394	82448055	395
810005	214	8143710	393	8183705	394	8249003	395
810006	207	81437055	393	8183706	394	8249004	395
8103703	393	815001	56	8183708	394	8249005	395

Index

8249006	395	8289010	396	829069	292	8294804	396
8249007	395	8289012	396	829070	292	8294805	396
8249008	395	829001	207	829071	292	8294806	396
8249009	395	829002	210	829072	293	8294807	396
8249010	395	829003	215	829073	293	8294808	396
8249011	395	829004	202	829074	293	8294809	396
82490055	395	829005	208	829075	293	8294810	396
825001	210	829006	202	829076	294	8294812	396
826001	216	829007	198	829077	294	8299005	397
8264808	395	829008	203	829078	294	8299006	397
8264810	395	829009	203	829079	298	8299007	397
8264815	395	829015	261, 276, 290	829080	299	8299008	397
8264820	395	829016	261, 265, 277, 282	829081	299	8299009	397
8264825	395	829017	258, 261, 277	829082	288, 299	8299010	397
8264827	395	829018	261, 271, 282	829083	259, 272	8299012	397
8264830	395	829019	262	829084	260, 273	830001	359
8264840	395	829020	262	829085	260, 273	83010005	397
8264845	395	829021	262	829086	260, 274	83010006	397
8264850	395	829022	262, 277, 286	829087	260, 273, 274	83010007	397
8264855	395	829023	263, 265, 283	829088	265, 269, 280	83010008	397
8264860	395	829024	263, 265	829089	269, 299	83010009	397
8269008	396	829025	263	829090	295	83010010	397
8269010	396	829026	263, 271, 277, 283	829091	280	83010012	397
8269015	396	829027	254	829092	295	83014005	397
8269020	396	829028	254	829093	295	83014006	397
8269025	396	829029	254	829094	269	83014007	397
8269027	396	829030	255, 283	829095	270	83014008	397
8269030	396	829031	255	829096	300	83014010	397
8269040	396	829032	255	829097	256	83014012	397
8269045	396	829033	256	829098	300	830100055	397
8269050	396	829034	256	829099	295, 299	832001	211
8274808	396	829035	283	829100	295	832002	211
8274810	396	829036	284	829101	256	83406204	397
8274815	396	829037	271, 289	829102	257	83406205	397
8274820	396	829038	284	829103	295	83406206	397
8274825	396	829039	264, 278, 284	829104	257	83406207	397
8274827	396	829040	266, 272, 285, 289	829105	257	83406208	397
8274830	396	829041	264, 285	829106	270	83406209	397
8274840	396	829042	266	829107	270, 272, 286, 289	83406210	397
8274845	396	829043	266	829108	296	83406212	397
8274850	396	829044	266, 298	829109	296	83406214	397
8274855	396	829045	267	829111	202	83406217	397
8274860	396	829046	267, 273	829113	199	83406219	397
8279008	396	829047	267	829115	296	83406222	397
8279010	396	829048	267, 298	829116	281	83406224	397
8279015	396	829049	268	829117	296	83406255	397
8279020	396	829050	268	829118	297	83410005	397
8279025	396	829051	268	829119	281	83410006	397
8279027	396	829052	269	829120	274	83410007	397
8279030	396	829053	271	829121	258	83410008	397
8279040	396	829054	275, 286	829122	297	83410009	397
8279045	396	829055	275, 278, 286	829123	297	83410010	397
8279050	396	829056	276, 278, 287	829124	274	83410011	397
828001	205	829057	287	829125	297	83410012	397
8284804	396	829058	287	829126	272, 289	83410013	397
8284805	396	829059	287	829127	281	83410014	397
8284806	396	829060	279	829128	281	83410017	397
8284808	396	829061	259, 279	829129	298	83414007	397
8284809	396	829062	279, 288, 290	829130	276, 288	83414010	397
8284810	396	829063	264, 269, 279, 285	829131	258	83414011	397
8284812	396	829064	259, 280, 290	829132	282	83414013	397
8289005	396	829065	280, 291	829133	300	83414014	397
8289006	396	829066	291	829134	275, 276, 282, 288	834106205	398
8289008	396	829067	291	829135	270	834106206	398
8289009	396	829068	292	829136	187	834106207	398

834106208	398	83806214	399	9142505	401	9367550	402
834106209	398	83806216	399	9182504	401	9367555	402
834106210	398	83806216T	399	9182505	401	9367560	402
834106212	398	83810005	399	9213001	401	9383005	402
834106213	398	83810006	399	9213002	401	9383006	402
834106214	398	83810008	399	9213003	401	9383008	402
834106217	398	83810009	399	9213004	401	9383010	402
83424806	397	83810010	399	9213601	401	9383012	402
83606220	398	83810012	399	9213602	401	9387505	402
83606225	398	83810014	399	9213603	401	9387506	402
83606227	398	83810016	399	9213604	401	9387508	402
83606230	398	83814010	399	9223002	401	9387510	402
83606240	398	83814012	399	9223003	401	9387512	402
83606245	398	83814014	399	9223004	401		
83606250	398	83810016T	399	9233008	401	A	
83606255	398	83880008	399	9233010	401	ASE27600100000	21, 101
83606260	398	83880010	399	9233012	401	ASE27600300000	15, 100
83606270	398	83906205	399	9233605	401		
83610020	398	83906206	399	9233606	401	S	
83610025	398	83906207	399	9233608	401	S403	174
83610027	398	83906208	399	9233610	401	S404	174
83610030	398	83906209	399	9233612	401	S409	174
83610040	398	83906210	399	9243007	401	S409-1	174
83610045	398	83906211	399	9243008	401	S413	174
83610050	398	83906212	399	9243010	401		
83610055	398	83906213	399	9243012	401	V	
83610060	398	83906214	399	9243014	401	VAS 275 001	101
83610070	398	83906216	399	9243604	401	VAS 275 001/1	101
83610080	398	83910005	399	9243605	401	VAS 275 001/2	101
83610090	398	83910006	399	9243606	401		
83614040	398	83910007	399	9243608	401		
83614045	398	83910008	399	9263040	402		
83614050	398	83910009	399	9263045	402		
83614055	398	83910010	399	9263050	402		
83614060	398	83910012	399	9263055	402		
83614070	398	83910013	399	9283006	402		
836100100	398	83910014	399	9283008	402		
83706220	398	83910016	399	9283010	402		
83706225	398	83912011	399	9343004	402		
83706227	398	83914010	399	9343005	402		
83706230	398	83924007	400	9343006	402		
83706240	398	83924008	400	9343007	402		
83706245	398	86807818	400	9343008	402		
83706250	398	86907805	400	9343010	402		
83706255	398	86907806	400	9343012	402		
83706260	398	86907807	400	9347504	402		
83706270	398	86907808	400	9347505	402		
83710020	398	86907809	400	9347506	402		
83710025	398	86907810	400	9347507	402		
83710027	398	86907812	400	9347508	402		
83710030	398	86907813	400	9347510	402		
83710040	398	86907814	400	9347512	402		
83710045	398	871192	227	9363020	402		
83710050	398	87810518	400	9363025	402		
83710055	398			9363030	402		
83710060	398	9		9363040	402		
83710070	398	9112501	400	9363045	402		
83710080	398	9112502	400	9363050	402		
83805517	204	9112503	400	9363055	402		
83806205	399	9132503	400	9363060	402		
83806206	399	9132504	400	9367520	402		
83806208	399	9132505	400	9367525	402		
83806209	399	9132506	400	9367530	402		
83806210	399	9142503	401	9367540	402		
83806212	399	9142504	401	9367545	402		



**WORK
EFFICIENT
WORK
WITH SONIC**



Alpha index

A

Accessory set, SFS	123
Adaptor	381
Adaptor set	189, 200-201
Adaptor set, on rail	183
Adaptors for drills	202
Adjustable wrench	345
Air bag removal tool set	205
Air conditioner tool set	218
Alternator bit socket	204
Alternator tools	204
Angle wrench	345
Angle wrench set, SFS	124
Assortment sets	222-226
Auxiliary belt tensioner spanner	282
Auxiliary drive belt wrench set	257, 295
Axial joint tool	217

B

Balance shaft alignment tool	258
Balance shaft setting kit	256
Ball joint separator	212
Battery charger	251
Belt gauge	214
Bin drawer for MSS	62
Bit holder	381, 382
Bit set	186
Bit socket set	188
Bit socket set SAE, on rail	179, 181, 183
Bit socket set SAE, SFS	128
Bit socket set, BMCS	165, 167-169, 173
Bit socket set, on rail	179-184
Bit socket set, SFS	123-124, 128, 131-138, 145, 149-151, 156-158
Bit sockets	390-402
Bit sockets, SAE	393, 395, 398
Bits	400-402
Blind hole bearing puller set	217
Blind rivet assortment	223
BMCS (Blow Mould Case Storage)	162-175
BMCS, empty	174
Body bolts and speed nuts assortment	223
Bolt twister socket set	202
Bolt, nut and washer assortment	223
Booster	242-251
Booster spare parts	247
Bottle jack	233
Bottle opener	403
Brake adaptor set	207
Brake bleeder wrench set	199
Brake caliper service set	208
Brake caliper socket	330
Brake fluid tester	206
Brake pipe corrosion tool	208
Brake piston rewinding cube	210
Brake piston spindle	208
Butt connector assortment	225

C

Cable reel	234-235
Cable ties	52
Cambelt tensioner tool set	296
Cambelt tensioner wrench	270, 295, 299
Cambelt timing kit	270
Camshaft alignment kit	280, 291, 297
Camshaft holding tool	265, 269, 280
Camshaft locking set	216, 262, 277, 286
Camshaft setting tool	269, 299
Camshaft valve timing kit	274
Can holder for toolbox	56-57
Car seat cover	213
Cardan socket	320-321, 323-324, 327, 331
Cardan socket set, on rail	181-182
Carry cases, filled	104-105
Carry cases, empty	29, 104
Casters for service cart	58
Casters for toolbox	58
Casters for topbox	58
Catalog	403
Center punch	363
Chisel	363
Chisel set, SFS	126, 140-143, 153-154
Circle nose pliers	359
Circlip assortment	222
Clamp tensioner cv boot tool	210
Cleaning brush kit	210
Clevis pin assortment	224
Clip remover	194
Clutch aligner set	214
Combination pliers	357
Combination set SAE, SFS	128
Combination set, BMCS	165-167, 173
Combination set, SFS	122, 130-135, 150-151, 157
Combination wrench	342
Combination wrench set	124-125, 190
Combination wrench set SAE, SFS	128
Combination wrench set, SAE	190
Combination wrench set, SFS	124-125
Combination wrench, SAE	342
Common rail flow meter set	215
Compression test set	215
Connector assortment	223
Cotter pin driver	194
Cotter pin puller	368
Crankshaft holding tool	256-257, 269, 290, 297, 299
Crankshaft holding tool wrench	297
Craw foot set	211
Creepers	213
Crimp terminals assortment	224
Crimping pliers set	197
Crocodile clip assortment	223
Cross rim wrench	199
Cutting set, SFS	152-153, 158
Cylinder pressure meter set	216

D			
Damper pulley puller wrench set	199	Flare nut wrench set, SFS	124
Diagonal pliers	357-358	Flare nut wrench, SAE	340
Diesel injection pump timing kit	300	Flexible cable hose clamp removing pliers	198
Diesel injector seat cleaner set	210	Flexible hose clip driver set	187
Diesel injector socket set	215	Flyer	403
Disc ratchet	377, 403	Flywheel/ front pulley locking tool	276, 288
Disc ratchet set	187	Foam spacer	127
Display box for MSS	52	Fork rod set	217
Displays	302-309	Front panel guide set	295
Document holder for toolbox	57	Front pulley holding tool	257
Door lock dismantling tool	198	Front pulley locking tool	276, 288
Double open wrench	341	Fuel pump drive belt kit	297
Double open wrench set, SAE	190	Fuel pump puller	270
Double open wrench set, SFS	124	Fuel sender/ pump clamping ring removal tool	203
Double open wrench, SAE	341	Fuel tool set	218
Double ring wrench	345	Fuses assortment	223-224
Doughnut stretcher	216		
Drain pan	213	G	
Drain plug gasket assortment	224	Gear and bearing split tools	210
Drain plug key set	203	Gloves	219
Drawer rails for toolbox	58	Glow plug joint socket	199
Drawers for MSS	61	Glow plug pliers	359
Drawers for toolbox	60-61	Glow plug socket	324
Drawers for topbox	61	Glow plug socket set	199
		Grease nipple assortment	223
		Grill cover	213
E		Grip key sets, SFS	121, 144, 155
E-circlip assortment	222	Grommet assortment	223
Empty toolboxes	10-26		
Empty tray for MSS	52	H	
Engine crane	233	Half-moon wrench	345
Engine service lit	300	Hammer	198, 364-365
Engine timing kit	254-300	Hammer set, SFS	126, 140, 142-143, 154-155
Engine timing kit, BMW	254-256	Handle for toolbox	55
Engine timing kit, Chevrolet, Chrysler	258, 261, 277	Heat gun	211
Engine timing kit, Fiat, Alfa	261, 276, 290	Hex ball grip key	315
Engine timing kit, Ford	261, 265, 277, 282	Hex ball grip key set, SFS	121, 144
Engine timing kit, Honda	271	Hex key set	194, 349-350
Engine timing kit, Iveco	261, 271, 282	Hex key set, SAE	349-350
Engine timing kit, Jaguar	271, 289	Hex key wrench	352
Engine timing kit, Jeep	260, 273	Hex key wrench set, SFS	121
Engine timing kit, Mazda	267, 273	Hex key wrench, SAE	352
Engine timing kit, Mercedes	260, 273, 274	Hex nut driver	314-315
Engine timing kit, Nissan	275, 276, 282, 288	Hex nut driver set, SFS	120, 144, 155
Engine timing kit, Opel	276, 278, 287	Hinged driver	341
Engine timing kit, PSA	261, 265, 277, 282	Hinged socket wrench	340
Engine timing kit, Renault, Dacia	275, 286	Hinged socket wrench set, SFS	124
Engine timing kit, Rover, Land Rover	271, 289	Holder for trolley	25
Engine timing kit, Saab	261, 276, 290	Hollow pin assortment	222
Engine timing kit, VAG, Audi, Volkswagen	291-293,	Hook	369
Engine timing kit, Volvo	266, 298	Hook for MSS	51
Extension	379-380	Hook set	194
Extension set	199	Hook set, SFS	127
		Hose clamp pliers	361
F		Hose clamp pliers set	198
Feeler gauge	367	Hose clamp set	223
Fender protection system	213	Hose clip pliers	361
Fender protector	213	Hot air gun	211
File	366		
File set, SFS	127	I	
Filled carry cases	104-105	Impact adaptor	381
Filled tool bag	106-107	Impact adaptor set	189, 200-201
Filled toolboxes	64-101, 111-112	Impact bit holder	382
Filled topboxes	103, 108	Impact bit socket	400
Fitting hook	216	Impact bit socket set	190
Flag	403	Impact driver	186
Flare nut wrench	340	Impact extension	380
Flare nut wrench set	191	Impact socket	329-334
Flare nut wrench set, SAE	191	Impact socket set	190, 200-201

Alpha index

Impact socket set, SFS	123, 137-138, 154	Plastic top cover for toolbox	55
Impact universal joint	381	Pliers	354-361
Impact wrench set, SFS	137	Pliers holder for MSS	52
Infrared thermometer	221	Pliers set, SFS	126-127, 140-141, 152-153, 158
Injection pump wrench	345	Pocket bits	186
Injector tool set	215	Precision screwdriver set	186
Insert holder for bits	382	Propulstation	248-250
J		Protractor	367
Jack	230-233	Pry bar	370
Jack stands	233	Pry bar set	195
Jacket	404	Pry remover set	195
K		Puller	212
Key cord	403	Puller set	217
Key for storage systems	63	Pulley wrench set	199
Key ring	403	R	
Key sets	346-353	Radiator hose remover	368
Key with lock for storage systems	63	Radiator pressure test set	216
Knee pad	219	Ratchet	372-383
Knife	366	Ratchet screwdriver	186, 315
L		Ratcheting wrench	343-344
Laptop holder	25	Ratcheting wrench set	191
Lights	236-241	Ratcheting wrench set, SFS	124
Lock ring pliers	359	Recycle bin for MSS	63
Locking nut assortment	225	Recycle bin for SWS	63
Locking pliers	360	Refractometer	205
Long nose pliers	357, 359	Repair set ratchet	375-378
M		Repair set swivel handle	378
Magnet	382	Repair set torque wrenches	387
Magnet pick-up	369, 370	Repair set universal joint	380
Magnetic bowl	214	Reversible puller	212
Magnetic tray	214	Ring wrench	344-345
Measuring tape	367	Ring wrench set, SAE	191
Metal knob for MSS shelves	61	Ring wrench set, SFS	125
Mirror	370	Ring wrench, SAE	344
MSS (Modular Storage System)	42-53	Riveting nut pliers	221
MSS+ (Modular Storage Solutions)	30-41	Riveting pliers	361
Multi function socket set	189	Roller seat	213
Multimeter	220	Rubber mat for toolbox	54
N		Ruler	367
Nut assortment	223	S	
Nut breaker set	217	S10 glass toolbox, empty	17
O		S10 toolbox, empty	16
Oil drain pan	213-214	S10 toolbox, filled	71-83
Oil drain repair set	207	S11 toolbox, empty	18
Oil drain set	203	S11 toolbox, filled	84-89
Oil filter cap	206	S12 toolbox, empty	19
Oil filter pliers	361	S12 toolbox, filled	84-89, 112
Oil filter set	206-207	S12 VAS toolbox, empty	21
Oil filter set, SFS	125	S12 XD toolbox, empty	20
Oil filter wrench	206	S12 XD toolbox, filled	90-93
Oil pressure set	215	S13 toolbox, empty	22
Oil pump alignment plate	270, 272, 286, 289	S13 toolbox, filled	94-95
O-ring assortment	222-223	S14 toolbox, empty	23
Oxygen sensor socket	214	S14 toolbox, filled	87-92, 97
Oxygen sensor wrench	214	S15 toolbox, empty	24
P		S15 toolbox, filled	88, 90-92, 97
Panel remover	368-369	S7 toolbox, empty	12
Paper holder for toolbox	55-56	S7 toolbox, filled	67
Petrol engine test set	216	S8 toolbox, empty	13
Pin assortment	222	S8 toolbox, filled	68
Pin punch	363	S9 toolbox, empty	14
Pin punch set	363	S9 toolbox, filled	70-83, 111
		S9 VAS toolbox, empty	15, 100
		Sample set, BMCS	166, 403
		Saw	365
		Scissor jack	233
		Scissor joint pliers	359

Scraper	368	Tooth belt tool set	216
Scraper set	194	Topboxes, empty	29
Screen holder	25	Topboxes, filled	103, 108
Screwdriver	310-316	Torque impact adaptor socket set	200
Screwdriver holder for MSS	52	Torque impact socket	329
Screwdriver set	185	Torque impact socket set	200-201
Screwdriver set, SFS	120, 129-131, 147, 156, 159	Torque multiplier	211
Seal assortment	222	Torque wrench set	388
Sealing rings assortment	222	Torque wrenches	384-389
Separating fork	217	Tower pincers	358
Service cart	27	TPMS set, BMCS	165
Shears	365	Transmission jack	233
Shelf for MSS	63	Trash can for toolbox	57
Shelf for SWS	63	Trim clip assortment	225-226
Shirt	404	Trim pad tool	368
Shrink tube assortment	225	Trim removal	368
Shrinking hose assortment	222	Twin camshaft locking tool	262, 277, 286
Side table for toolbox	57	TX key set	194, 350-351
Skirting boards MSS	63	TX key wrench	353
Slide hammer puller set	211	TX key wrench set, SFS	121
Sliding T-handle	379	TX set, BMCS	170
Slow motion system foor reels	235	TX wrench	344-345
Snap ring assortment	222	Tyre carrier	219
Snap ring pliers	359	Tyre profile gauge	367
Snap ring pliers set, SFS	126	Tyre repair tool set	205
Socket set	187-189	Tyre valve driver	205
Socket set impact, SFS	123	Tyre valve stem fitting tool	205
Socket set SAE, on rail	179-183		
Socket set SAE, SFS	128, 138, 145	U	
Socket set, BMCS	162-175	Universal joint	380
Socket set, on rail	176-183	Universal joint set, on rail	183
Socket set, SFS	123-124, 128, 131-138, 145, 149-151, 156-158		
Socket, SAE	320, 322-323, 326, 328,	V	
Sockets	316-336	Vacuum pump set	216
Spark plug pliers	359	Valve setting kit	269
Spark plug socket	335	Vernier caliper	367
Speedy grip	379	Vibration damper holding tool	297
Spinner	378	Volt circuit tester	220
Spiral socket set	201	Voltage tester	314
Spring compressor	227-229		
Spring compressor set	219	W	
Sprocket holding tool	300	Washer assortment	224
Stainless steel worktop for toolbox	54-55	Water pump pliers	358
Star grip key	315	Water pump puller kit	296
Storage case for MSS	52	W-clip assortment	222
Stripping pliers	358	Wedge	196
Sump plug removal tool	203	Wedge set	196
Support shaft for S10 windshield toolbox	55	Welder's grip pliers	360
Sweater	404	Wheel hanger set	202
Swivle handle	378	Wheel nut key set	187, 202
Synchroniser rings assortment	222	Wheel socket	328-330
		Wheel socket set	200
T		Wheel weight balance pliers	361
Tablet holder	25	Wing and grill cover	213
Taper punch	363	Wiper removal kit	211
Tensile and compression spring assortment	222	Wire brush	366-367
Tent	403	Wire stripper	358
Terminal release tool set	218	Wooden worktop for toolbox	55
Test lead set	218	Worktop for toolbox	54
Tie rap holder for MSS	52	Wrench set	190-191
Timing chain fitting bridge	274	Wrench set SAE, SFS	128, 145
Timing chain locking kit	258	Wrench set, BMCS	170, 172-173
Timing chain tensioner lever	269, 295	Wrench set, SAE	190-191
Timing tools	252-301	Wrench set, SFS	124-125, 131, 138-139, 148, 151-152, 159-160
Tool holder for trolley	56	Wrenches	336-346
Tool bag	106-107	Wrenches, SAE	341-344
Toolboxes, empty	10-26		
Toolboxes, filled	64-101, 111-112		
Tools kit set, SFS	127, 144		

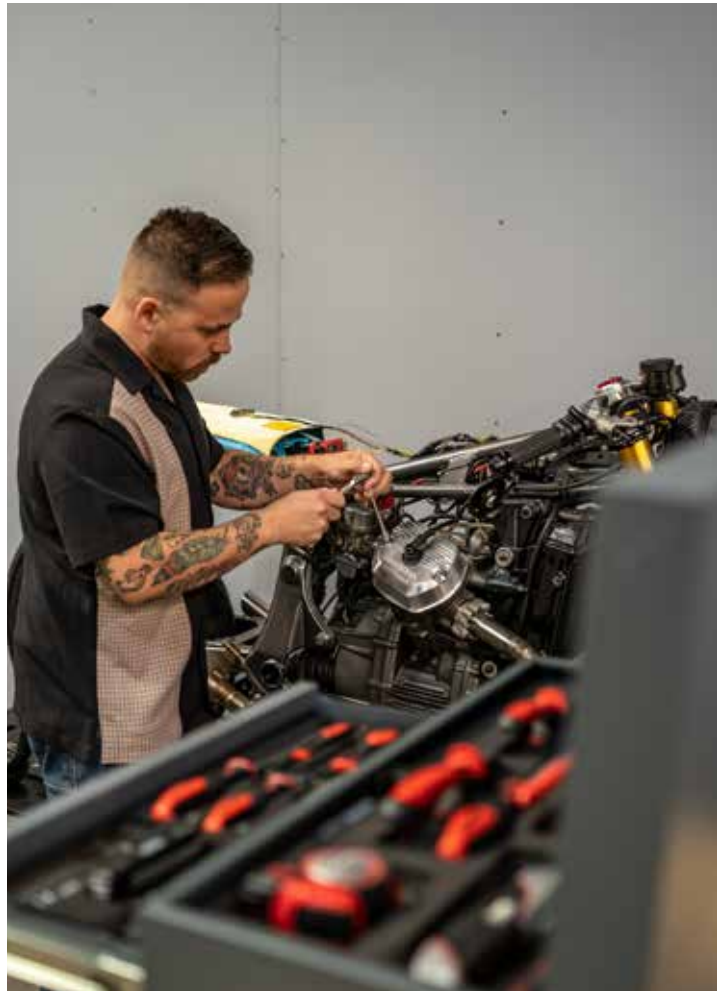









**WORK
EFFICIENT
WORK
WITH SONIC**





**ARE YOU
READY?**

**WORK
EFFICIENT
WORK
WITH SONIC**

SONIC EQUIPMENT BV
Component 114 - 116
1446 WP Purmerend
The Netherlands
Tel. +31 299 437 000
Fax +31 299 436 610
info@sonic-equipment.com

- Sonic Equipment
- sonic.equipment
- Sonic Equipment Global
- Sonic Equipment BV

