

GLOBAL BESTSELLERS 2022

SONIC



**WORK
EFFICIENT
WORK
WITH SONIC**



SONIC-EQUIPMENT.COM

SONIC



WORK EFFICIENT WORK WITH SONIC

sonic-equipment.com



Scansiona i codici QR di questa brochure con il tuo telefono per maggiori informazioni sui prodotti mostrati.



8

Carrelli vuoti



12

Termoformati
Sonic Foam System (SFS)



38

Zaino
attrezzi



18

Carrelli attrezzati



37

Carrelli attrezzati
Volkswagen



40

Cassette e valigie



42

MSS+



52

MSS



58

BMCS



61

Bussole su binario



64

Lampade



66

Sollevatori



68

Boosters



69

Avvolgicavo



70

Giraviti



71

Chiavi

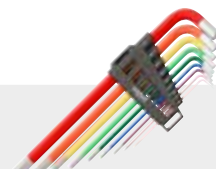

72

Chiavi maschio



75

Pinze e martelli



76

Cricchetti



78

Chiave dinamometrica



79

Altri utensili



91

Assortimenti di minuteria



94

Utensili VDE



96

Utensili manuali



103

Kit di messa in fase

Il nostro compito.

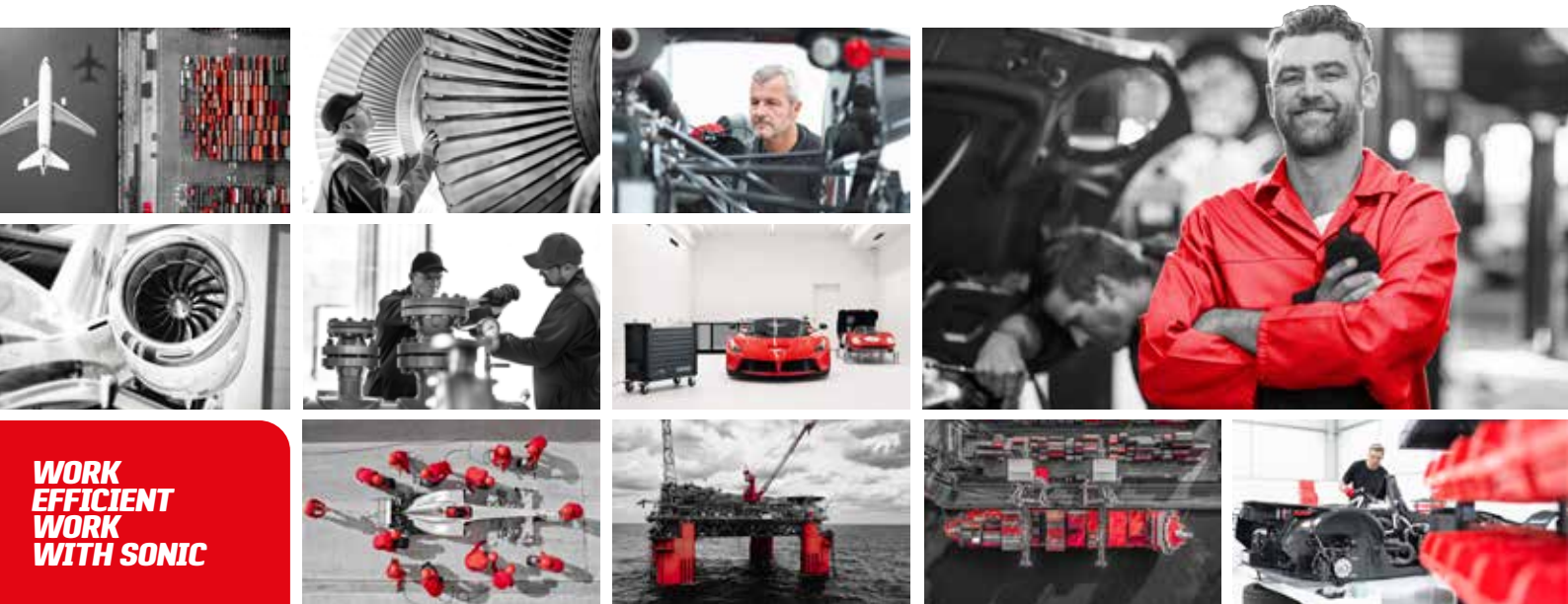

Accrescere l'affidabilità nei servizi tecnici offrendo **Efficienza, Stile** e **Supporto** ai professionisti di tutto il mondo.

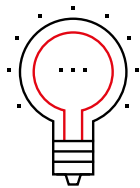

Efficienza

La soluzione perfetta per te:

Offriamo il giusto equilibrio tra design, qualità e prezzo



Stile

Unisciti alla squadra vincente:

I nostri prodotti sono testati e comprovati dai vincitori

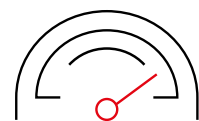

Supporto

Ci prendiamo cura di te:

Il nostro team è lì per supportarti e sempre pronto a fare il possibile

Il nostro DNA.

Sonic Equipment è uno dei principali specialisti nello sviluppo, nella distribuzione di utensili manuali e professionali, sistemi e soluzioni di stoccaggio. Fondata nel 2004, ora un marchio leader con vendite in oltre 65 paesi in tutto il mondo. Oltre al settore automobilistico, Sonic é attiva nei settori agricoli, autocarro, industria, marittima, aviazione, bici e motociclette.

Il nostro obiettivo è fornire la soluzione perfetta per i tecnici professionisti, sempre con il giusto equilibrio tra design, qualità e prezzo. Ispirare fiducia ai tecnici e consentire loro di eccellere nel loro lavoro quotidiano con gioia e soddisfazione.

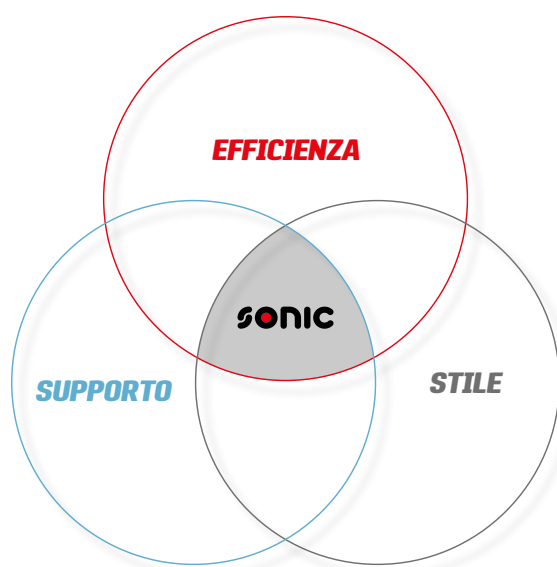

Sonic è rappresentata in oltre 65 paesi in tutto il mondo.

Riguardo a noi.

- Il quartier generale di Sonic Equipment si trova nei Paesi Bassi e comprende tra l'altro un magazzino di 5.000 m² e il Sonic Experience Center
- La società ha anche strutture e magazzini in Germania, Francia, Taiwan e Stati Uniti
- Attiva nei settori Automobilistico, Agricoltura, Autocarro, Industria, Marittimo, Aviazione, Biciclette e Motociclette.

Scegli lo strumento adatto a te

B**BASIC**

L'etichetta **Basic** classifica una soluzione completa per i tecnici principianti.

I**INTERMEDIATE**

L'etichetta **Intermediate** classifica una soluzione completa per tecnici qualificati.

A**ADVANCED**

L'etichetta **Advanced** classifica una soluzione avanzata per tecnici esperti.

E**EXPERT**

L'etichetta **Expert** classifica una soluzione completa per i tecnici più esperti, pronti a qualsiasi sfida.

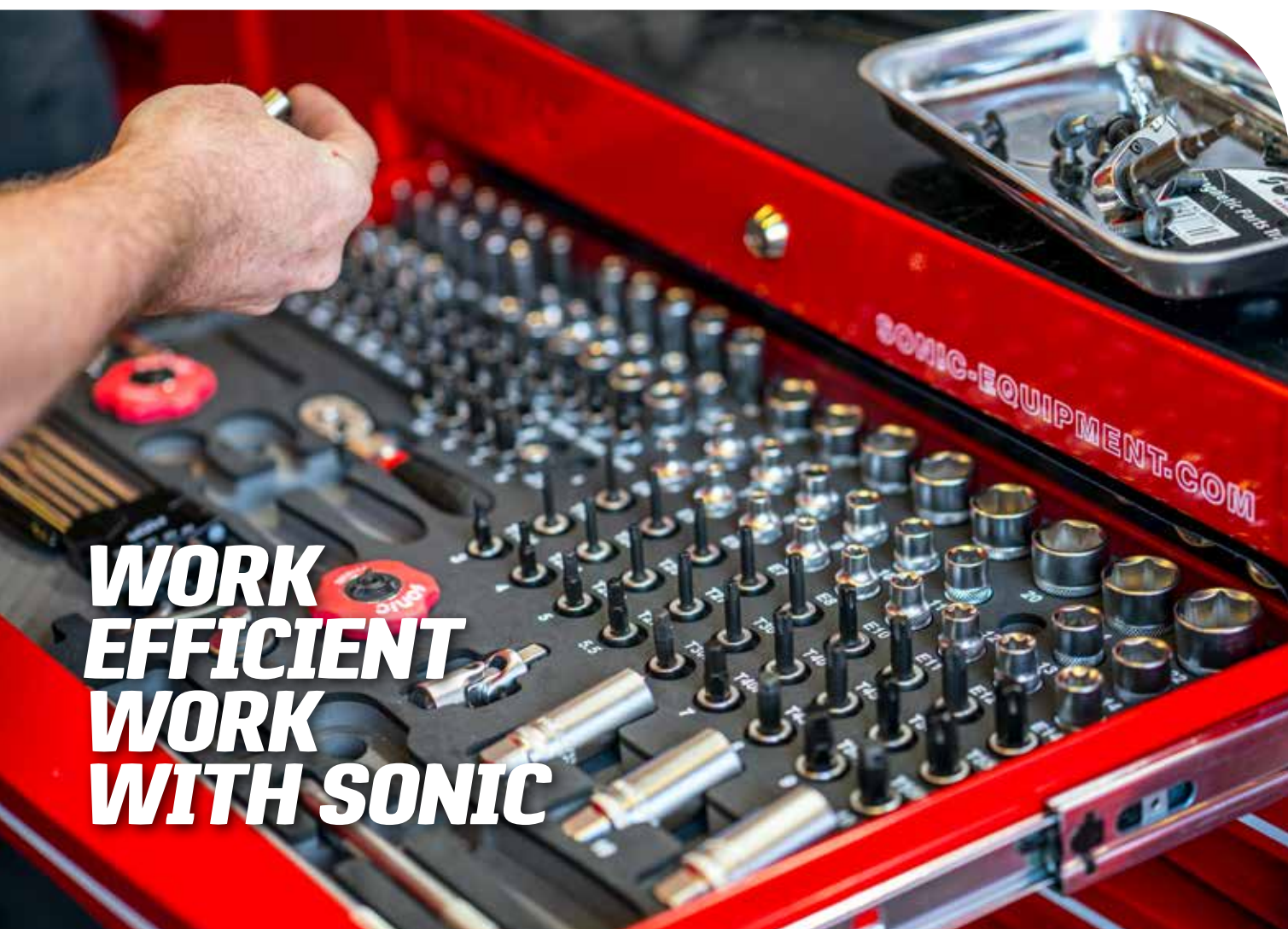

**WORK
EFFICIENT
WORK
WITH SONIC**



Studi sull'efficienza temporale hanno **confermato l'efficacia del nostro sistema Sonic Foam System.**

Lavora più velocemente, in modo più efficiente e mantieni il tuo set completo.



20% PIÙ VELOCE TEMPO È DENARO
PRELIEVO E RIPOSIZIONAMENTO
 USANDO SONIC FOAM SYSTEM

78% PIÙ VELOCE PACE DELLA MENTE
INVENTARIO DEL CARRELLO
 USANDO SONIC FOAM SYSTEM

80% PIÙ VELOCE RISCHIO VS RICOMPENSA
UTENSILI PERSI
 USANDO SONIC FOAM SYSTEM



XS
 472 X 202MM

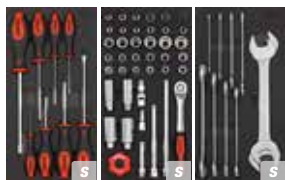

S S S
 1/3 190 X 370MM



M
 1X 570 X 370MM



L
 1X 745 X 435MM



XL
 1X 745 X 570MM

Sonic Foam System. Extra Small

Compatibile con questi carrelli

Sonic Foam System. Small

Compatibile con questi carrelli

Sonic Foam System. Medium

Compatibile con questi carrelli

Sonic Foam System. Large

Compatibile con questi carrelli

Sonic Foam System. Extra Large

Compatibile con questi carrelli



● RAL 9004 ● RAL 9006

Art. 4732110 **CARRELLO DI SERVIZIO € 288,50**



LARGHEZZA	ALTEZZA	PROFONDITÀ	PESO
956MM	1047MM	500MM	32,5KG

Note: extra large



● RAL 9004 ● RAL 9006

Art. 4732013 **CARRELLO DI SERVIZIO 3 CASSETTI € 485,58**

SFS SONIC FOAM SYSTEM Compatible con Sonic Foam System



LARGHEZZA	ALTEZZA	PROFONDITÀ	PESO
956MM	1047MM	500MM	51,5KG

Note: extra large
3 cassetti (L 775 x P 461 x A 65mm)



● RAL 9004

Art. 4733716 **S7 € 526,05**

SFS SONIC FOAM SYSTEM Compatible con Sonic Foam System



LARGHEZZA	ALTEZZA	PROFONDITÀ	PESO
731MM	911MM	463MM	48KG

6 cassetti; 4 cassetti (L 575 x P 370 x A 60mm), 2 cassettoni (L 575 x P 370 x A 137mm)



● RAL 9004

Art. 4730167 **S8 € 671,82**

SFS SONIC FOAM SYSTEM Compatible con Sonic Foam System



LARGHEZZA	ALTEZZA	PROFONDITÀ	PESO
688MM	1023MM	460MM	67KG

7 cassetti; 5 cassetti (L 575 x P 370 x A 65mm), 2 cassettoni (L 575 x P 370 x A 145mm)

S10



● RAL 9004 ● 3001 ● 5005 ● 7040

Art. 4730918 **S10** Art. 4730928 **S10**
 Art. 4730938 **S10** Art. 4730948 **S10** € 1058,62



Compatible con Sonic Foam System



8 cassetti; 7 cassetti (L 575 x P 370 x A 65mm), 1 cassettone (L 575 x P 370 x A 145mm)

S11



● RAL 9004 ● 3001 ● 5005 ● 7040

Art. 4731118 **S11** Art. 4731128 **S11**
 Art. 4731138 **S11** Art. 4731148 **S11** € 1303,42



Compatible con Sonic Foam System

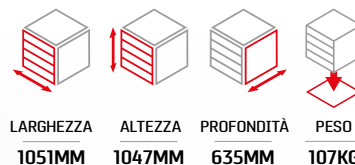

8 cassetti; 7 cassetti (L 740 x P 435 x A 65mm), 1 cassettone (L 740 x P 435 x A 145mm)

S13



● RAL 9004

Art. 47308113 **S13** € 2127,28



Compatible con Sonic Foam System

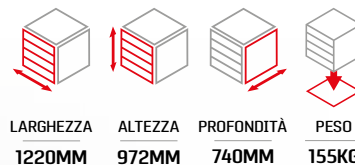

13 cassetti; 9 cassetti (L 570 x P 370 x A 65mm), 2 cassettoni (L 570 x P 370 x A 145mm), 2 cassetti piccoli (L 145 x P 370 x A 65mm)

S14



● RAL 9004

Art. 47307118 **S14** € 2323,48



Compatible con Sonic Foam System

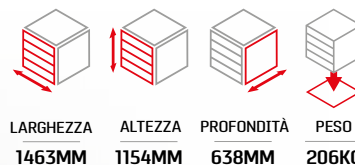

18 cassetti; 8 cassetti (L 750 x P 570 x A 65mm), 8 cassetti (L 370 x P 570 x A 65mm), 1 cassettone (L 750 x P 570 x A 145mm), 1 cassettone (L 370 x P 570 x A 145mm)

S15



● RAL 9004

Art. 47338114 **S15 € 2877,02**

 CHIUSURA CENTRALIZZATA	 GUIDE CON CUSCINETTI A SFERA	 RUOTA GIREVOLE CON FRENO	 304 TOP IN ACCIAIO INOX
 PORTA FLACONI	 PORTATA MAX CASSETTO	 PORTATA MAX CARRELLO	 SISTEMA ANTIRIBALTAMENTO



Compatibile con Sonic Foam System



 LARGHEZZA	 ALTEZZA	 PROFONDITÀ	 PESO
1667MM	1160MM	710MM	240KG

14 cassetti; 7 cassetti (L 750 x P 570 x A 75mm), 5 cassetti (L 570 x P 570 x A 75mm), 1 cassetto (L 570 x P 570 x A 155mm), 1 cassetto (L 1435 x P 570 x A 195mm)

S9



● RAL 7011

Art. 4732418 **S9 € 872,26**

 CHIUSURA CENTRALIZZATA	 GUIDE CON CUSCINETTI A SFERA	 RUOTA GIREVOLE CON FRENO	 304 TOP IN ACCIAIO INOX
 PORTA FLACONI	 PORTATA MAX CASSETTO	 PORTATA MAX CARRELLO	 SISTEMA ANTIRIBALTAMENTO



Compatibile con Sonic Foam System



 LARGHEZZA	 ALTEZZA	 PROFONDITÀ	 PESO
859MM	1035MM	532MM	84KG

8 cassetti; 7 cassetti (L 575 x P 370 x A 60mm), 1 cassetto (L 575 x P 370 x A 145mm)

S12



● RAL 7011

Art. 4732718 **S12 € 1035,23**

 CHIUSURA CENTRALIZZATA	 GUIDE CON CUSCINETTI A SFERA	 RUOTA GIREVOLE CON FRENO	 304 TOP IN ACCIAIO INOX
 PORTA FLACONI	 PORTATA MAX CASSETTO	 PORTATA MAX CARRELLO	 SISTEMA ANTIRIBALTAMENTO



Compatibile con Sonic Foam System



 LARGHEZZA	 ALTEZZA	 PROFONDITÀ	 PESO
1030MM	1035MM	532MM	97KG

8 cassetti; 7 cassetti (L 750 x P 435 x A 65mm), 1 cassetto (L 750 x P 435 x A 145mm)

S12 XD



● RAL 7011

Art. 4734218 **S12XD € 1514,77**

 CHIUSURA CENTRALIZZATA	 GUIDE CON CUSCINETTI A SFERA	 RUOTA GIREVOLE CON FRENO	 304 TOP IN ACCIAIO INOX
 PORTA FLACONI	 PORTATA MAX CASSETTO	 PORTATA MAX CARRELLO	 SISTEMA ANTIRIBALTAMENTO



Compatibile con Sonic Foam System



 LARGHEZZA	 ALTEZZA	 PROFONDITÀ	 PESO
1027MM	1054MM	668MM	123KG

8 cassetti; 7 cassetti (L 750 x P 570 x A 65mm), 1 cassetto (L 750 x P 570 x A 145mm) x T 570 x H 145mm)



Art. 4730224 **CASSETTIERA VUOTA** € 556,24



 CHIUSURA CENTRALIZZATA	 GUIDE CON CUSCINETTI A SFERA	 MANIGLIA	 304 TOP IN ACCIAIO INOX
----------------------------	----------------------------------	--------------	--------------------------------



Compatibile con Sonic Foam System

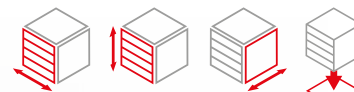

LARGHEZZA	ALTEZZA	PROFONDITÀ	PESO
589MM	464MM	532MM	39KG

● RAL 7011

4 cassetti (L 570 x P 370 x A 65mm)



Art. 4733014 **CASSETTIERA TROLLEY VUOTA** € 656,98



 CHIUSURA CENTRALIZZATA	 GUIDE CON CUSCINETTI A SFERA	 MANIGLIA	 RUOTA GIREVOLE CON FRENO
 304 TOP IN ACCIAIO INOX			



Compatibile con Sonic Foam System

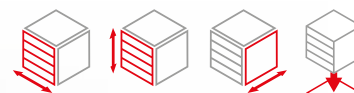

LARGHEZZA	ALTEZZA	PROFONDITÀ	PESO
859MM	643MM	532MM	46KG

● RAL 7011

4 cassetti (L 570 x P 370 x A 65mm)

Vari bracci con base per **S9, S12, S12XD**



€ 64,96

Art. 47725
Porta laptop



€ 54,11

Art. 47726
Porta Tablet



€ 50,44

Art. 47727
Porta LCD

La soluzione ideale e flessibile per professionisti mobili. Offre una migliore ergonomia del computer e un ambiente di lavoro migliore

- lega leggera
- regolazione in altezza istantanea
- attacco e rilascio rapidi, afferra saldamente il laptop



€ 118,91

Art. 47728
Braccio snodato porta laptop



€ 111,72

Art. 47729
Braccio snodato porta tablet



€ 108,53

Art. 47730
Braccio snodato porta LCD

€ 57,79



Art. 47724
Base per braccio porta laptop/tablet/monitor, per carrelli S9/S12/S12XD



S S S
190 X 370MM



Art. 600823
Set giraviti 1/3 SFS, 8 pezzi

€ 39,76

S S S
190 X 370MM



Art. 600625
Set di giraviti lunghi 1/3 SFS, 6 pezzi

€ 42,05

S S S
190 X 370MM

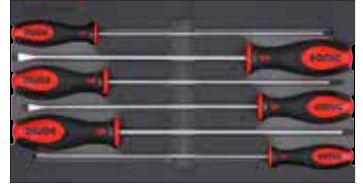

Art. 600626
Set di giraviti lunghi 1/3 SFS, 6 pezzi

€ 42,16

S S S
190 X 370MM



Art. 600824
Set giraviti TX 1/3 SFS, 8 pezzi

€ 41,73

S S S
190 X 370MM



Art. 600627
Set di giraviti TX lunghi 1/3 SFS, 6 pezzi

€ 45,52

S S S
190 X 370MM

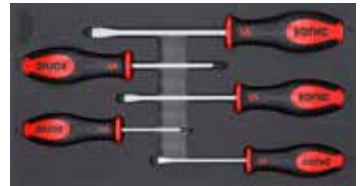

Art. 600513
Set di giraviti a battere SFS 1/3, 5 pezzis

€ 41,49

S S S
190 X 370MM

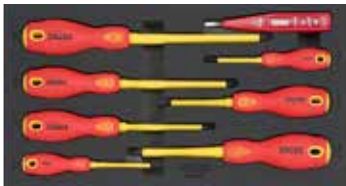

Art. 600826
Set giraviti 1/3 VDE SFS, 8 pezzi

€ 49,49

S S S
190 X 370MM



Art. 600717
Set giraviti a bussola 1/3 SFS, 7 pezzi

€ 63,33

S S S
190 X 370MM



Art. 600718
Set di chiavi maschio Hex punta sferica con impugnatura 1/3 SFS, 7 pezzi

€ 48,64

S S S
190 X 370MM

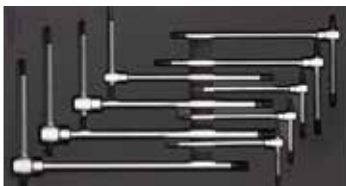

Art. 600913
Set di chiavi a T maschio con 3 punte 1/3 SFS, 9 pezzi

€ 76,56

S S S
190 X 370MM

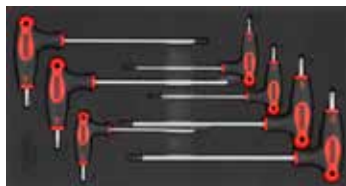

Art. 600719
Set di chiavi maschio piegate con impugnatura TX 1/3 SFS, 7 pezzi

€ 43,09

S S S
190 X 370MM

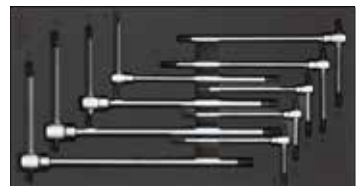

Art. 600914
Set chiavi a T TX con 3 punte 1/3 SFS, 9 pezzi

€ 78,00

S S S
190 X 370MM



Art. 106303
Set di chiavi a bussola profilo flank 6pt. 1/4", SFS 1/3, 61 pezzi

€ 120,21

S S S
190 X 370MM



Art. 110201
Set di chiavi a bussola a giravite 1/4", SFS 1/3 102 pezzi

€ 173,52

S S S
190 X 370MM



Art. 201401
Set di chivi combinate 3/8", SFS 1/3 14 pezzi

€ 142,40

S S S
190 X 370MM



Art. 204101
Set di chiavi a bussola a giravite 3/8", SFS 1/3, 41 pezzi

€ 126,56

S S S
190 X 370MM

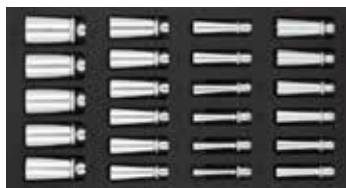

Art. 202301
Set di chiavi a bussola 3/8" lunghe, SFS 1/3 23 pezzi

€ 67,81

S S S
190 X 370MM

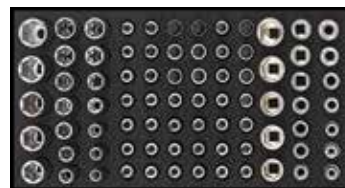

Art. 208001
Set di chiavi a bussola a giravite 3/8", SFS 1/3 80 pezzi

€ 167,68

S S S
190 X 370MM



Art. 203001
Set di chiavi a bussola a giravite 3/8", SFS 1/3, 30 pezzi

€ 75,44

S S S
190 X 370MM



Art. 300608
Set accessori 1/2" SFS 1/3, 6 pezzi

€ 80,15

S S S
190 X 370MM



Art. 300908
Set accessori 1/2" SFS 1/3, 9 pezzi

€ 113,68

S S S
190 X 370MM



Art. 302301
Set accessori 1/2" SFS 1/3, 23 pezzi

€ 108,64

S S S
190 X 370MM



Art. 303805
Set di chiavi a bussola a giravite 1/2", SFS 1/3, 38 pezzi

€ 103,84

S S S
190 X 370MM



Art. 305605
Set di chiavi a bussola a giravite 1/2", SFS 1/3, 56 pezzi

€ 167,97

S S S
190 X 370MM



Art. 301603
Set di chiavi a bussola a macchina 1/3 lunghe SFS, 16 pezzi

€ 127,65

S S S
190 X 370MM



Art. 302003
Set di chiavi a bussola 1/2" lunghe, SFS 1/3, 20 pezzi

€ 98,45

S S S
190 X 370MM



Art. 302204
Set chiavi a bussola e chiavi a giravite 1/2" 1/3 SFS, 22 pezzi

€ 87,57

S S S
190 X 370MM



Art. 302104
Set di chiavi a bussola a giravite 1/2", SFS 1/3, 21 pezzi

€ 83,36

S S S
190 X 370MM



Art. 601017
Set chiavi a forchetta doppia SFS 1/3, 10 pezzi

€ 124,29

S S S
190 X 370MM



Art. 600708
Set chiavi a bussola incernierate SFS 1/3, 7 pezzi

€ 72,45



S S S
190 X 370MM



Art. 601016
Set di chiavi a forchetta SFS 1/3, 10 pezzi

€ 77,09

S S S
190 X 370MM

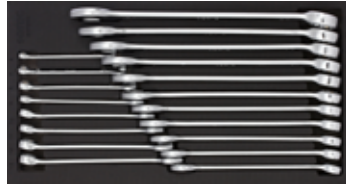

Art. 601903
Set di chiavi combinate SFS 1/3, 19 pezzi

€ 118,21

S S S
190 X 370MM

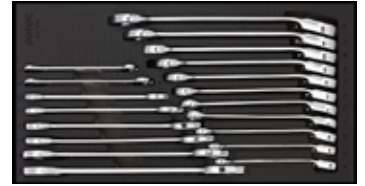

Art. 601904
Set di chiavi combinate a cricchetto e a forchetta 1/3 SFS, 19 pezzi

€ 232,53

S S S
190 X 370MM



Art. 601228
Set chiavi a cricchetto combinata 12pt. SFS 1/3, 12 pezzi

€ 184,24

S S S
190 X 370MM



Art. 601229
Set chiavi a cricchetto combinata reversibile 12pt. 1/3 SFS, 12 pezzi

€ 212,96

S S S
190 X 370MM



Art. 601230
Set chiavi a cricchetto combinata snodata 12pt. SFS 1/3, 12 pezzi

€ 237,09

S S S
190 X 370MM



Art. 601225
Set di chiavi SFS 1/3, 12 pezzi

€ 114,21

S S S
190 X 370MM



Art. 600435
Set chiavi poligonali doppia curvata 75° SFS 1/3, 4 pezzi

€ 77,76

S S S
190 X 370MM



Art. 603004
Set di chiavi SFS 1/3, 30 pezzi

€ 110,93

S S S
190 X 370MM

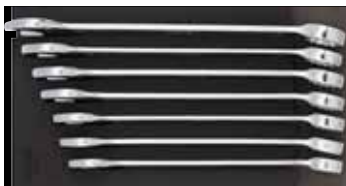

Art. 600709
Set di chiavi combinate SFS 1/3, 7 pezzi

€ 108,80

S S S
190 X 370MM



Art. 602205
Set per filtro olio SFS 1/3, 22 pezzi

€ 104,88

S S S
190 X 370MM



Art. 600432
Set pinze 1/3 SFS, 4 pezzi

€ 119,76

S S S
190 X 370MM



Art. 600434
Set pinze 1/3 VDE SFS, 4 pezzi

€ 165,60

S S S
190 X 370MM



Art. 600430
Set pinze a becchi dritti per anelli elastici SFS 1/3, 4 pezzi

€ 87,50

S S S
190 X 370MM



Art. 600825
Set pinze 1/3 SFS, 8 pezzi

€ 195,58

S S S
190 X 370MM



Art. 600319
Set martelli SFS 1/3, 3 pezzi

€ 82,44

S S S
190 X 370MM



Art. 601227
Set scalpelli e cacciapine con impugnatura SFS 1/3, 12 pezzi

€ 84,05

S S S
190 X 370MM



Art. 600614
Set lime SFS 1/3, 6 pezzi

€ 70,64

S S S
190 X 370MM



Art. 600705
Set pinze e utensili 1/3 SFS, 7 pezzi

€ 97,17

S S S
190 X 370MM



Art. 600822
Set di ganci 1/3 SFS, 8 pezzi

€ 59,92

S S S
190 X 370MM



Art. 600623
Set di ganci 1/3 SFS, 8 pezzi

€ 44,48

S S S
190 X 370MM

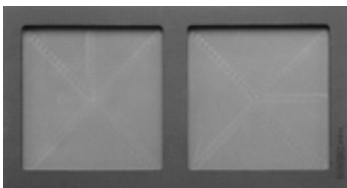

Art. 47613
Termoformato da 1/3

€ 10,69

S S S
190 X 370MM



Art. 106304
Set chiavi a bussola a profili flank 1/4", 6 pt. [SAE] SFS 1/3 61 pezzi

€ 117,09

S S S
190 X 370MM

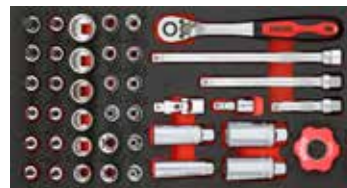

Art. 204102
Set di chiavi a bussola a giravite 3/8", [SAE] SFS 1/3 41 pezzi

€ 122,08

S S S
190 X 370MM



Art. 202302
Set di chiavi a bussola 3/8" lunghe, [SAE] SFS 1/3 23 pezzi

€ 87,28

S S S
190 X 370MM



Art. 302005
Set accessori 1/2" [SAE] SFS 1/3, 9 pezzi

€ 99,68

S S S
190 X 370MM



Art. 302004
Set di chiavi a bussola 1/2" lunghe, [SAE] SFS 1/3 20 pezzi

€ 100,96

S S S
190 X 370MM



Art. 303806
Set di chiavi a bussola a giravite 1/2", [SAE] SFS 1/3 38 pezzi

€ 106,77

S S S
190 X 370MM



Art. 601406
Set di chiavi combinate [SAE] SFS 1/3, 14 pezzi

€ 103,25



Guarda online l'intera gamma
dei termoformati **Sonic Foam System**



M
570 X 370MM

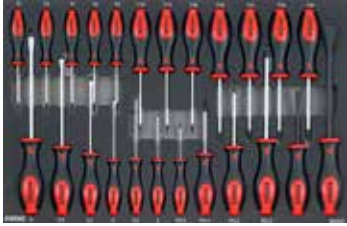

Art. 602407
Set giraviti SFS, 24 pezzi

€ 126,21

M
570 X 370MM



Art. 603506
Set giraviti SFS, 35 pezzi

€ 145,23

M
570 X 370MM



Art. 112102
Set di chiavi combinate 1/4", SFS 121 pezzi

€ 284,24

M
570 X 370MM



Art. 602904
Set giraviti e chiavi SFS, 29 pezzi

€ 208,72

M
570 X 370MM



Art. 106105
Set di chiavi e giraviti 1/4" SFS, 61 pezzi

€ 232,64

M
570 X 370MM



Art. 214702
Set di chiavi combinate 1/4", & 3/8", SFS 147 pezzi

€ 479,73

M
570 X 370MM



Art. 215702
Set di chiavi combinate 1/4", & 3/8", SFS 157 pezzi

€ 368,37

M
570 X 370MM



Art. 311201
Set di chiavi a bussola a giravite 1/4", 3/8" & 1/2", SFS 112 pezzi

€ 314,24

M
570 X 370MM



Art. 313902
Set di chiavi a bussola a giravite 1/4", 3/8" & 1/2", SFS 139 pezzi

€ 408,56

M
570 X 370MM



Art. 206501
Set di chiavi combinate 3/8", & 1/2", SFS 65 pezzi

€ 255,92

M
570 X 370MM



Art. 310101
Set di chiavi combinate 3/8" & 1/2", SFS 101 pezzi

€ 309,92

M
570 X 370MM



Art. 309507
Set di chiavi combinate 1/2", SFS 95 pezzi

€ 436,16

M
570 X 370MM



Art. 403201
Set di chiavi a bussola 3/4" metrico [SAE] SFS, 32 pezzi

€ 510,08

M
570 X 370MM



Art. 307302
Set di chiavi a bussola a macchina 3/8" & 1/2" SFS, 74 pezzi

€ 359,92

M
570 X 370MM



Art. 403301
Set di chiavi a bussola a macchina 3/4" SFS, 33 pezzi

€ 587,89

M

570 X 370MM



Art. 603002
Set di chiavi, SFS 30 pezzi

€ 385,25

M

570 X 370MM



Art. 604002
Set di chiavi, SFS 40 pezzi

€ 319,33

M

570 X 370MM

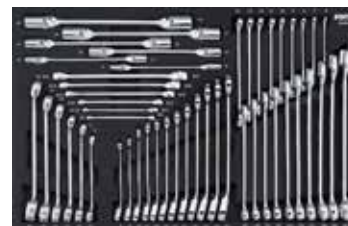

Art. 604901
Set di chiavi, SFS 49 pezzi

€ 491,92

M

570 X 370MM



Art. 601506
Set pinze e martello SFS, 15 pezzi

€ 309,33

M

570 X 370MM



Art. 602302
Set di martelli, scalpelli, pinze e lime SFS, 23 pezzi

€ 324,37

M

570 X 370MM



Art. 601207
Set pinze SFS, 12 pezzi

€ 280,00

M

570 X 370MM



Art. 602007
Set martello e scalpelli SFS, 20 pezzi

€ 229,02

M

570 X 370MM



Art. 602104
Set giraviti a bussola Hex & chiavi maschio piegate con impugnatura SFS, 21 pezzi

€ 180,69

M

570 X 370MM



Art. 601309
Carrello Multifunzione MOT SFS 13-pcs

€ 451,66

M

570 X 370MM

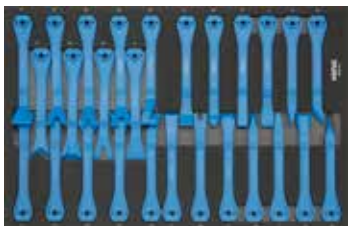

Art. 602712
Kit di leverini Master SFS, 27 pezzi

€ 64,72

M

570 X 370MM



Art. 601907
Set di chiavi per filtri olio, 19 pezzi

€ 166,16

M

570 X 370MM



Art. 604302
Dispositivo di pressione e rotazione dei pistoncini dei freni, SFS, 43 pezzi

€ 285,89

M

570 X 370MM



Art. 310001
Set chiavi a bussola 1/4" 3/8" & 1/2" 12 pt. (SAE) SFS, 100 pezzi

€ 260,16



M

570 X 370MM



Art. 309301
Set chiavi a bussola 12pt. 1/4" 3/8" 1/2" (SAE) SFS, 93 pezzi

€ 351,76



M

570 X 370MM



Art. 603101
Set di chiavi (SAE) SFS, 31 pezzi

€ 232,40



S7 TOOLS 140 PCS

Art. 714040 **S7 € 1073,07**

S7 carrello 6 cassetti,
dotato di **140 utensili** in 3 cassetti



B

BASIC

1 106105



2 206501



3 601404



M

1X 570 X 370MM

S8 TOOLS 149 PCS

Art. 714906 **S8 € 1441,96**

S8 carrello 7 cassetti,
dotato di **149 utensili** in 3 cassetti



B

BASIC

1

600823



106303



302301



2

601903



601016



600432



3

600705



600319



601227



S S S

1/3 190 X 370MM

S8 TOOLS 158 PCS

Art. 715806 **S8 € 1400,18**

S8 carrello 7 cassetti,
dotato di **158 utensili** in 3 cassetti



B

BASIC

1 602904



2 311201



3 601707



M

1X 570 X 370MM



Art. 728406 **S8 € 1721,28**

S8 carrello 7 cassetti,
dotato di **285 utensili** in 4 cassettei

B

BASIC

M

1X 570 X 370MM



LARGHEZZA
688MM

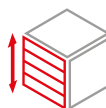

ALTEZZA
1022MM



PROFONDITÀ
460MM



PESO
67KG



112102



2310101



3604002



4602302



Art. 724131 **S9** € 1558,32

S9 carrello 8 cassetti,
dotato di **241 utensili** in 4 cassetti

B

BASIC

M

1X 570 X 370MM



LARGHEZZA
859MM

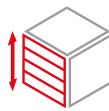

ALTEZZA
1035MM



PROFONDITÀ
532MM



PESO
84KG



1 602407

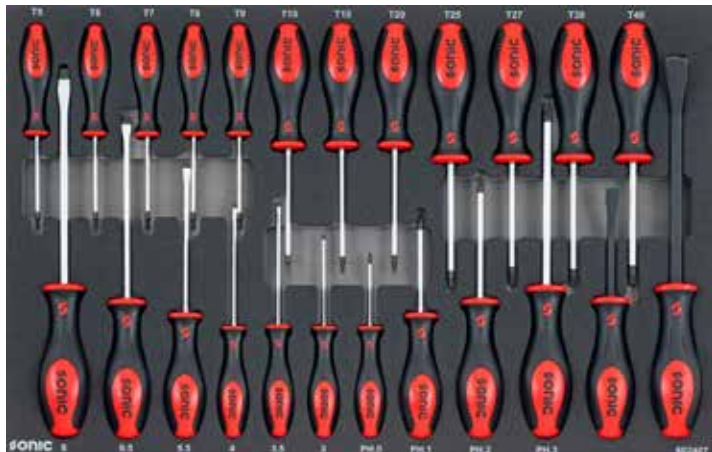

2 316001



3 604002



4 310707



- Art. 730231 **S9** € 2365,01
- Art. 730209 **S10** € 2553,22
- Art. 730215 **S10** € 2553,22
- Art. 730216 **S10** € 2553,22
- Art. 730219 **S10** € 2553,22



I
INTERMEDIATE

S S S
1/3 190 X 370MM



S9 e S10 carrello 8 cassetti,
dotato di **302 utensili** in 6 cassetti



- Art. 735431 **S9** € 2721,43
- Art. 735409 **S10** € 2909,61
- Art. 735415 **S10** € 2909,61
- Art. 735416 **S10** € 2909,61
- Art. 735419 **S10** € 2909,61



I
INTERMEDIATE

M
1X 570 X 370MM



S9 e S10 carrello 8 cassetti,
dotato di **354 utensili** in 6 cassetti



**CONTIENE CHIAVI
REVERSIBILI A CRICCHETTO**

Art. 734931 **S9** € 2911,28

ALLESTIMENTO RIPARAZIONI MOTO

S9 carrello 8 cassetti,
dotato di **349 utensili** in 6 cassetti



M
1X 570 X 370MM

- Carrello da officina pieno per meccanici professionisti di moto
- Kit completo di attrezzi per moto giapponesi ed europee
- Set completo di chiavi a bussola e bit da 1/4", 3/8" e 1/2", incluse 3 chiavi dinamometriche
- Attrezzo rapido con impugnatura a T per un lavoro rapido ed efficiente
- Il set contiene una chiave combinata con cricchetto
- Il cassetto 8 é vuoto per utensili vari
- Staffa per laptop, schermo o tablet disponibile opzionalmente



LARGHEZZA
859MM

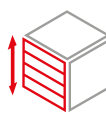

ALTEZZA
1035MM



PROFONDITÀ
532MM



PESO
84KG



1 602716



2 214301



3 305002



4 605304



5 604207



6 601606



7 601806

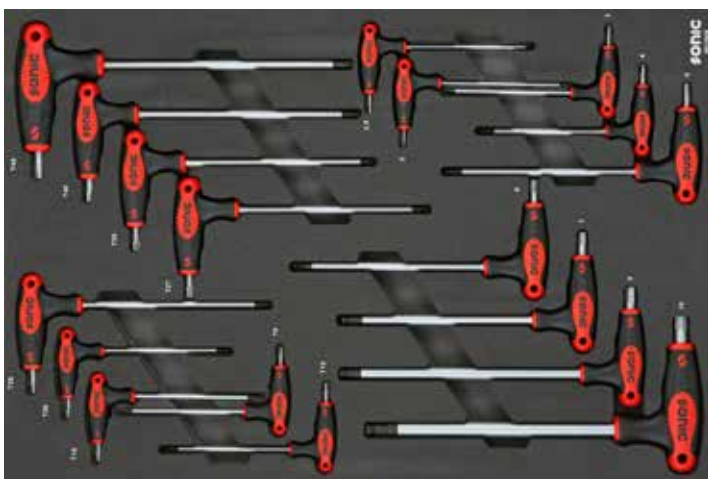

Set 305002 contiene la chiave dinamometrica 1/2", 40-200Nm.

Satz 214301 contiene chiave dinamometrica 1/4", 5-25Nm + chiave dinamometrica 3/8", 10-50Nm

- Art. 736931 **S9 € 2474,10**
- Art. 736909 **S10 € 2662,28**
- Art. 736915 **S10 € 2662,28**
- Art. 736916 **S10 € 2662,28**
- Art. 736919 **S10 € 2662,28**

S9 e S10 carrello 8 cassetti,
dotato di **369 utensili** in 6 cassette



S9 **TOOLS** 369 **PZS**



I

INTERMEDIATE

M

1X 570 X 370MM

1 602407



2 215702



3 309502



4 604002



5 603003

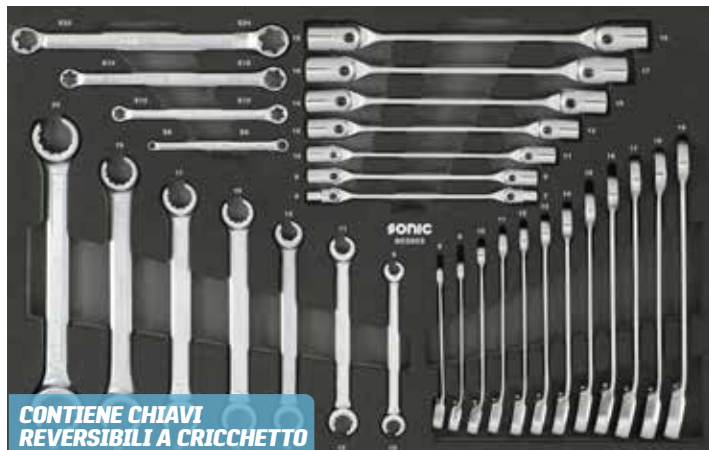

6 602302



- Art. 742031 **S9 € 2679,04**
- Art. 742009 **S10 € 2867,23**
- Art. 742015 **S10 € 2867,23**
- Art. 742016 **S10 € 2867,23**
- Art. 742019 **S10 € 2867,23**



S9 +TOOLS 420 PCS

A

ADVANCED

S10 +TOOLS 420 PCS

M

1X 570 X 370MM



S9 e S10 carrello 8 cassetti,
dotato di **420 utensili** in 6 cassette

1602407

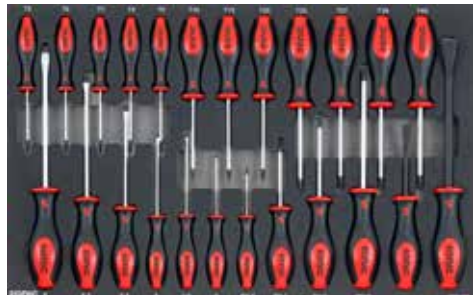

2215702



3309502



4307302



5604901



CONTIENE CHIAVI
REVERSIBILI A CRICCHETTO

6602209



- Art. 752731 **S9 € 3198,56**
- Art. 752709 **S10 € 3386,74**
- Art. 752715 **S10 € 3386,74**
- Art. 752716 **S10 € 3386,74**
- Art. 752719 **S10 € 3386,74**



S9 +TOOLS 527 PCS

A

ADVANCED

S10 +TOOLS 527 PCS



S9 e S10 carrello 8 cassetti,
dotato di **527 utensili** in 6 cassette

1	600823	600824	600822	2	201401	208001	203001	3	110201	300908	305605	4	302003	302204	302104
5	601903	601225	601904	6	603004	601017	301603	7	600319	601227	600614	8	600825	600705	600717

CONTIENE CHIAVI
REVERSIBILI A CRICCHETTO

SSS

1/3 190 X 370MM

- Art. 746009 **S10 € 3817,44**
- Art. 746015 **S10 € 3817,44**
- Art. 746016 **S10 € 3817,44**
- Art. 746019 **S10 € 3817,44**

S10 carrello 8 cassette,
dotato di **460 utensili** in 8 cassette

HEAVY DUTY



S10 **TOOLS** **460** PZS



A

ADVANCED

M

1X 570 X 370MM

112102



2310101



3603002



4604702

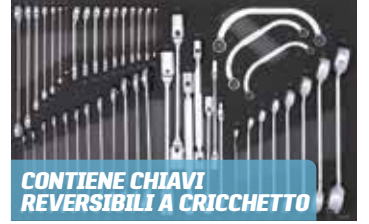

5307302



6403201



7403301



8602302



- Art. 754007 **S13 € 5443,52**

S13 carrello 13 cassette,
dotato di **540 utensili** in 11 cassette

HEAVY DUTY



S13 **TOOLS** **540** PZS

E

EXPERT

M

1X 570 X 370MM

1602407

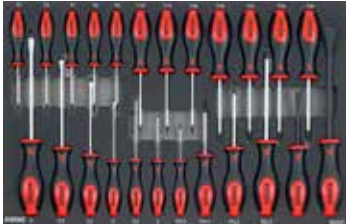

2215702



3309502



4603002

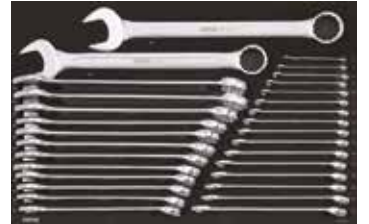

5604702

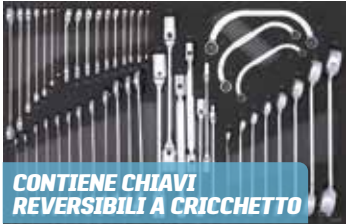

6601207

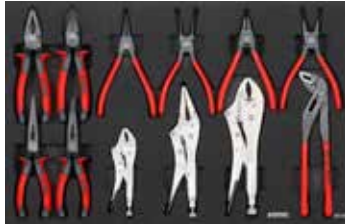

7601601



8307302



9403301



10403201



11602104



S12 **TOOLS** 158 **PCS**

Art. 715750 **CARRELLO DI SERVIZIO** € 1169,20
 Art. 715729 **S12** € 1717,63

B
BASIC

L

Carrello di servizio 3 cassetti,
dotato di **158 utensili** in 2 cassette

1X 745 X 435MM



S12 **TOOLS** 263 **PCS**

Art. 726329 **S12** € 2351,99

S12 carrello 8 cassetti,
dotato di **263 utensili** in 4 cassette

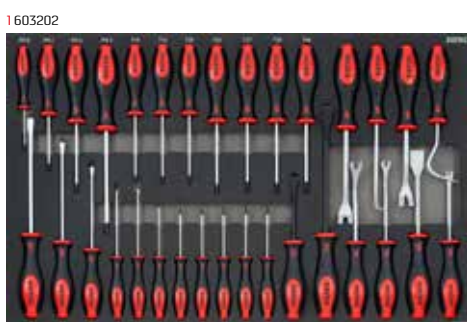

I

INTERMEDIATE

S12 **TOOLS** 345 **PCS**

Art. 734529 **S12** € 2813,30
 Art. 734511 **S11** € 3083,38
 Art. 734517 **S11** € 3083,38
 Art. 734518 **S11** € 3083,38
 Art. 734520 **S11** € 3083,38



I

INTERMEDIATE

S11 **TOOLS** 345 **PCS**



S11 e S12 carrello 8 cassetti,
dotato di **345 utensili** in 6 cassette

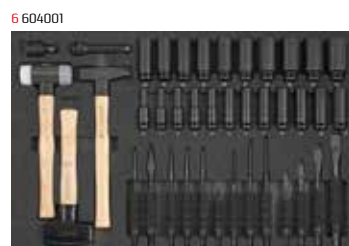

S12 **TOOLS** 400 **PCS**

- Art. 740029 **S12** € 3356,73
- Art. 740011 **S11** € 3626,85
- Art. 740017 **S11** € 3626,85
- Art. 740018 **S11** € 3626,85
- Art. 740020 **S11** € 3626,85



S11 e S12 carrello 8 cassetti,
dotato di **400 utensili** in 6 cassetti

Carrello attrezzato per officina universale, specializzata nella manutenzione
Volkswagen, Audi, Seat e Skoda

A

ADVANCED

L

1X 745 X 435MM

1 603207

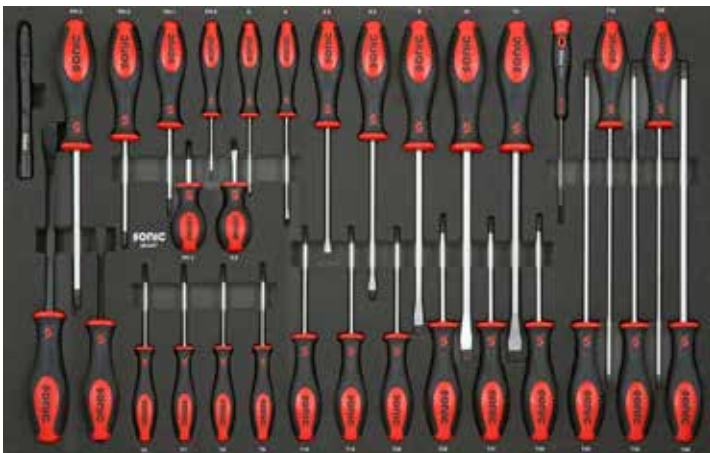

2 218502

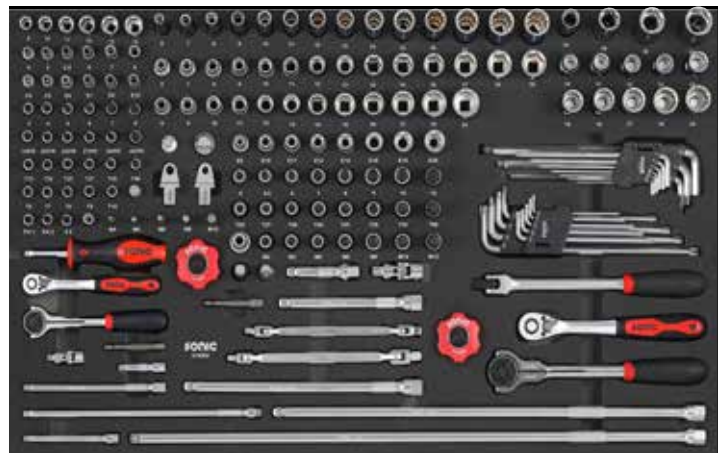

3 308201



4 605101

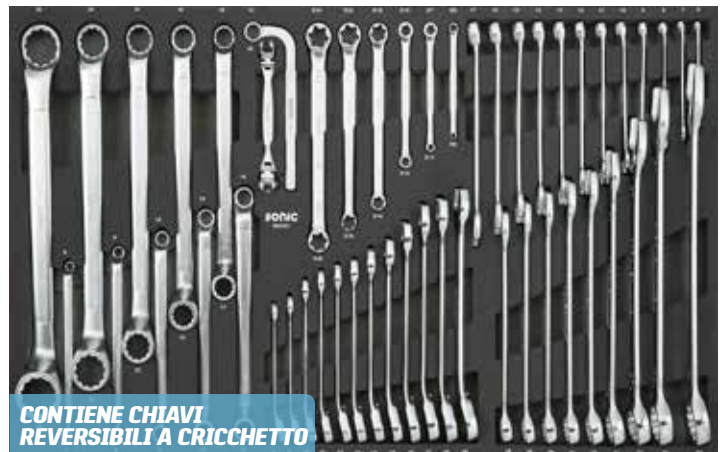

5 602308



6 602710



- Art. 748529 **S12 € 3479,82**
- Art. 748512 **S11 € 3749,89**
- Art. 748517 **S11 € 3749,89**
- Art. 748518 **S11 € 3749,89**
- Art. 748520 **S11 € 3749,89**



L

1X 745 X 435MM

S11 e S12 carrello 8 cassetti,
dotato di **485 utensili** in 7 cassetti



A
ADVANCED

1 603202

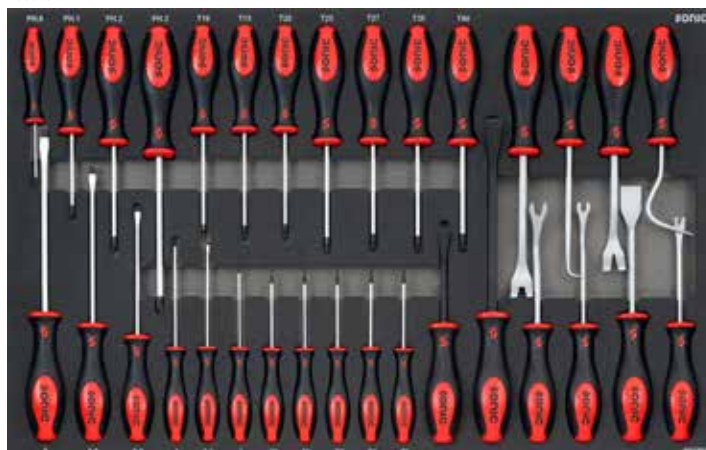

2 221201



3 308401



4 605301



**CONTIENE CHIAVI
REVERSIBILI A CRICCHETTO**

5 602204



6 604202



7 604001



- Art. 757529 **S12** € 3924,56
- Art. 757511 **S11** € 4194,64
- Art. 757517 **S11** € 4194,64
- Art. 757518 **S11** € 4194,64
- Art. 757520 **S11** € 4194,64



S11 e S12 carrello 8 cassetti, dotato di **575 utensili** in 7 cassetti



E
EXPERT

1114602



2216401



3311801



4605301



5602605



6602803



7604001



S12 TOOLS 644 PLUS

- Art. 764429 **S12** € 4361,47
- Art. 764411 **S11** € 4631,55
- Art. 764417 **S11** € 4631,55
- Art. 764418 **S11** € 4631,55
- Art. 764420 **S11** € 4631,55
- Art. 764408 **S14** € 5849,90

S11 e S12 carrello 8 cassetti
e S14 carrello 18 cassetti,
dotato di **644 utensili** in 7 cassetti



L

IX 745 X 435MM

S11 TOOLS 644 PLUS



S14 TOOLS 644 PLUS



Il carrello S14 è dotato di cassetti più capienti. Lo spazio nei cassetti verrà completato con dei termoformati.

1 114602



2 216401

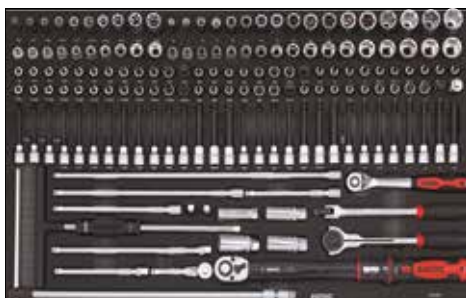

3 311801



4 605301

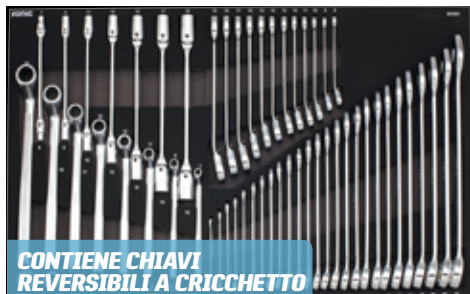

CONTIENE CHIAVI REVERSIBILI A CRICCHETTO

5 606901



6 602605



7 602803



8 604001



Art. 771446 **S12XD € 5597,15**

S12XD carrello 8 cassette,
dotato di **714 utensili** in 7 cassette



XL

1X 745 X 570MM

Un carrello attrezzato **extra largo**
e profondo con un **design robusto**



LARGHEZZA
1027MM

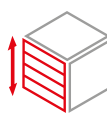

ALTEZZA
1054MM



EXTRA
PROFONDITÀ
668MM



PESO
123KG



1114101

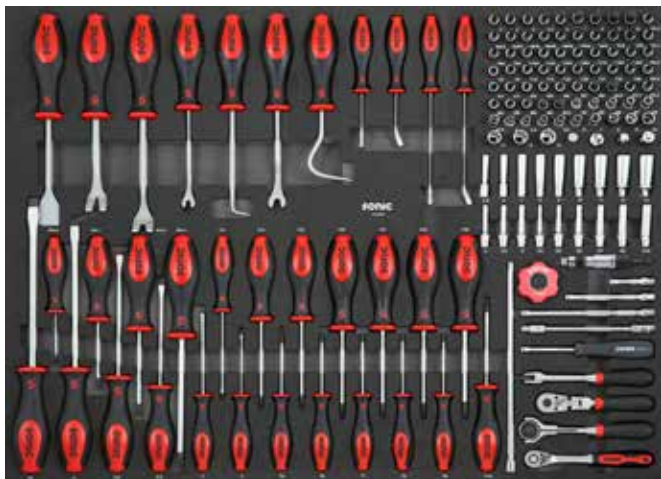

3 314901



5 603402



7 601806

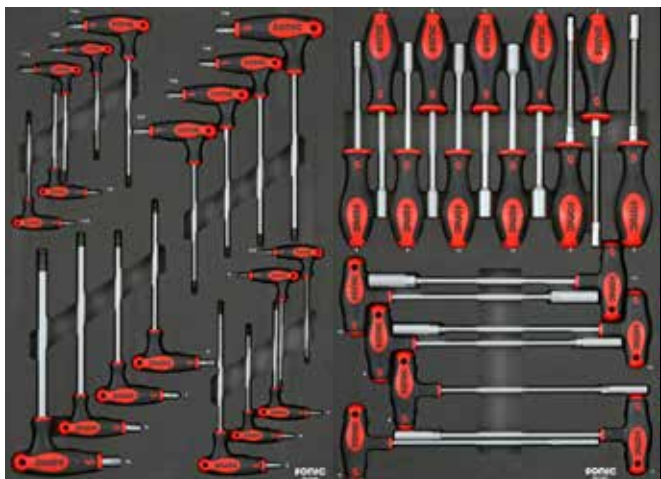

601807

2 221801



4 607201

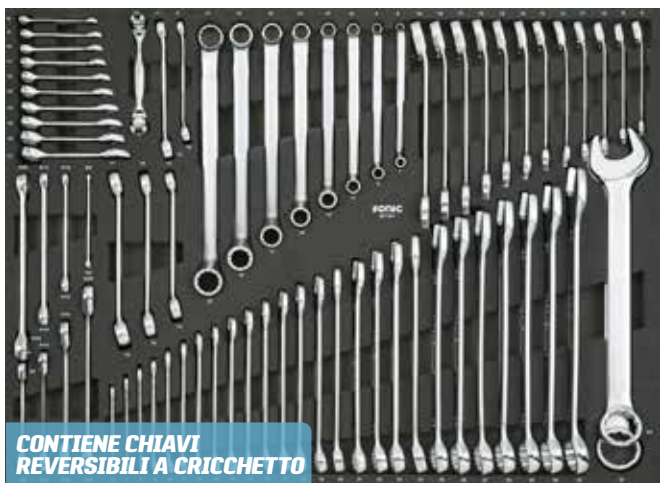

**CONTIENE CHIAVI
REVERSIBILI A CRICCHETTO**

6 604402



602007



Set 314901 contiene il set di chiavi a bussola 1/2" rivestite in plastica per cerchi in lega, 3 pezzi.



Set 221801 contiene la chiave dinamometrica 3/8", 20-100Nm.

Set 314901 contiene la chiave dinamometrica 1/2", 80-400Nm.

Art. 772346 **S12XD € 6738,13**

S12XD carrello 8 cassette,
dotato di **723 utensili** in 7 cassette



XL

1X 745 X 570MM

HEAVY DUTY

- Serie completa di bussole 1/4", 3/8" e 1/2"
- Set di chiavi a stella complete di misure grandi (32, 34, 36, 38, 41 e 46 mm)
- Vasto set di martelli incluso un martello senza battuta d'arresto
- Set di pinze con anello di sicurezza grande e pinza per pompa dell'acqua
- Punzoni ad alte prestazioni
- Set completo di chiavi a bussola da 1/2"
- Il carrello può essere ampliato con un kit chiavi dato e crichetto 3/4"



LARGHEZZA
1027MM

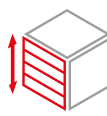

ALTEZZA
1054MM



EXTRA
PROFONDITÀ
668MM



PESO
123KG



1114101

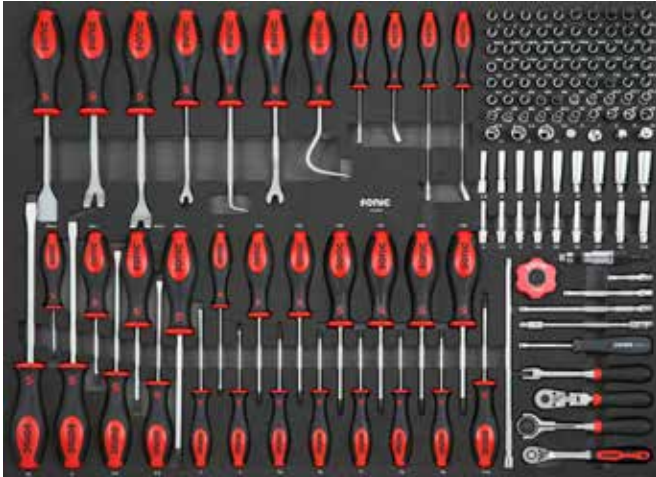

2221803



3311501



4606601



5606302



6603209



7601909



306901



Set 221801 contiene la chiave
dinamometrica 3/8", 20-100Nm.

Set 311501 contiene la chiave
dinamometrica 1/2", 20-100Nm.

Art. 795808 **S14** € 7709,54

Art. 795844 **S15** € 8437,98

S15 +TOOLS 958

S14 +TOOLS 958

E
EXPERT

S14 carrello 18 cassetti e S15 carrello 14 cassetti
dotato di **958 utensili** in 12 cassetti

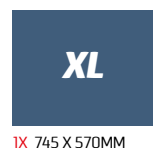

<p>1L 604501</p>	<p>1R 601808</p>	<p>47612*</p>	<p>2L 221801</p>	<p>2R 116901</p>	<p>47612*</p>
<p>3L 314901</p>	<p>3R 306402</p>	<p>47612*</p>	<p>4L 607201</p> <p>CONTIENE CHIAVI REVERSIBILI A CRICCHETTO</p>	<p>4R 605001</p>	<p>47612*</p>
<p>5L 604402</p>	<p>602007</p>	<p>5R 303902</p>	<p>47612*</p>	<p>6L 603402</p>	<p>47612*</p>
<p>7L 601806</p>	<p>601807</p>	<p>601807</p>	<p>601807</p>	<p>601807</p>	<p>601807</p>

S15

**Il carrello S15 è predisposto di cassetti più larghi. La vaschetta vuota serve a richiudere lo spazio vuoto.*



Set 314901 contiene il set di chiavi a bussola 1/2" rivestite in plastica per cerchi in lega, 3 pezzi.



Set 221801 contiene la chiave dinamometrica 732210100, 20-100Nm.
Set 314901 contiene la chiave dinamometrica 732380400, 80-400Nm.



S9

S12



VAS 276 003



VAS 276 001

Volkswagen AG sceglie Sonic

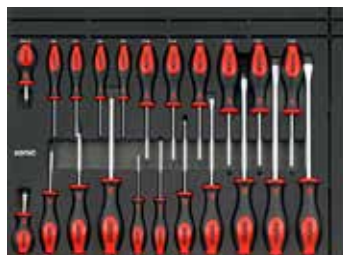

Assortimento base
VAS 275 001



Assortimento Audi
VAS 275 001/1

Assortimento Volkswagen
VAS 275 001/2

Assortimento carrozzeria
VAS 275 001/3

Dopo una lunga selezione Volkswagen ha deciso di iniziare una collaborazione con Sonic. Specificamente per Volkswagen, Sonic ha sviluppato 2 carrelli attrezzati, basandosi sul carrello S9 e S12. Questi carrelli vengono consegnati nel colore Volkswagen e sono attrezzati con assortimenti di utensili sviluppati appositamente per Volkswagen, riposti in assortimenti in schiuma. Esclusivamente disponibili in Volkswagen e presso i loro centri di distribuzione.

Questi carrelli sono disponibili solo attraverso il canale vendita Volkswagen AG.

BORSA ATTREZZO PER USO PROFESSIONALE

- Art. 47799 **ZAINO PER ATTREZZI VUOTO** € 133,00
- Art. 708401 **ZAINO CON ATTREZZI DI BASE 84 PEZZI** € 555,45
- Art. 711201 **ZAINO COMPLETO DI ATTREZZI 112 PEZZI** € 685,12

A
ADVANCED



- Dimensioni zaino per attrezzi (L x L x A): 33 x 24 x 47cm
- Volume: 16L
- Peso a vuoto: 2,6kg
- Capacità di carico massima: 20kg

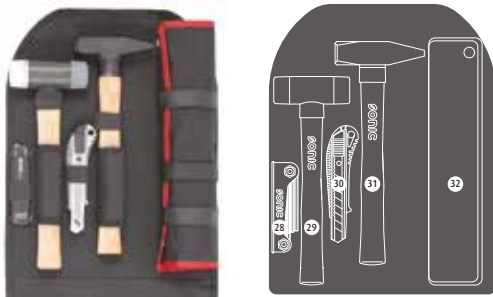
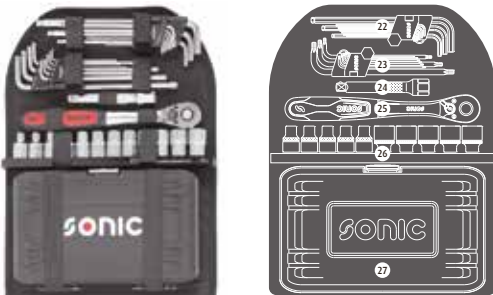
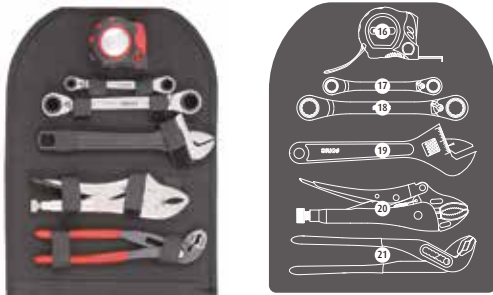
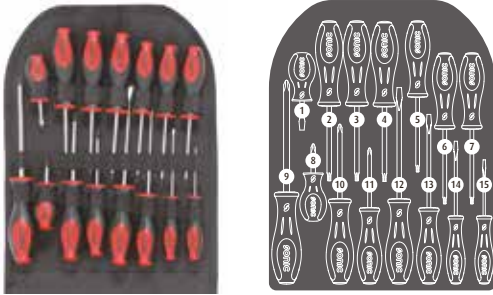

	NR	BASIC	ADVANCED	ART.	DIMENSIONI	LUNGHEZZA
	1		V	133055S	5.5mm	104mm
	2		V	13630	T30	215mm
	3		V	13627	T27	215mm
	4		V	13625	T25	215mm
	5		V	13620	T20	203mm
	6		V	13615	T15	203mm
	7		V	13610	T10	203mm
	8		V	1312S	PH.2	104mm
	9	V	V	1313	PH.3	274mm
	10	V	V	1312	PH.2	215mm
	11	V	V	1311	PH.1	183mm
	12	V	V	13365	6.5mm	265mm
	13	V	V	13355	5.5mm	228mm
	14	V	V	13304	4mm	192mm
	15	V	V	13303	3mm	167mm
	16	V	V	47013	5M	81mm
	17		V	4170401	8-10, 12-13	160mm
	18		V	4170402	16-17, 18-19	230mm
	19	V	V	42301250	10"	250mm
	20	V	V	4380250	10"	230mm
	21	V	V	4352250	10"	250mm
	22		V	601008	1,27, 1,5, 2, 2,5, 3, 4, 5, 6, 8, 10mm	
	23		V	600902	T10, T15, T20, T25, T27, T30, T40, T45, T50	
	24		V	7143125	12.5 1/2"	125mm
	25	V	V	7121503	12.5 1/2"	262mm
	26	V	V	301201	12.5 1/2"	8, 9, 10, 11, 12, 13, 14, 15, 16, 17, 18, 19mm
	27	V	V	103502	6.3 1/4"	1/4" Bussole e bit, set 35 pezzi
	28	V		600713		2,5, 3, 4, 5, 6, 8, 10mm
	29		V	4620400		40mm
	30	V	V	46806		157mm
	31	V	V	4611400		400g
	32	V	V	601409		6, 7, 8, 9, 10, 11, 12, 13, 14, 15, 16, 17, 19, 22mm
	33		V	45112160		12mm
	34		V	45118190		18mm
	35		V	4564185		4mm
	36	V	V	4341175		7"
	37		V	4311175		7"
	38	V	V	4321200		8"

- Art. 713201 **VALIGIA PIENA XL** € 876,97
- Art. 47502 **VALIGIA VUOTA XL** € 313,63
- Art. 713202 **VALIGIA ATTREZZATA TROLLEY XL** € 1002,24
- Art. 47503 **VALIGIA TROLLEY VUOTA XL** € 416,54

Caratteristiche

- Dimensioni:
L 410 x P 485 x A 215mm
- Peso: 6,5KG
- Materiale:
ABS, nero













Valigia attrezzata, **132 pezzi**



Caratteristiche

- Dimensioni:
L 410 x P 485 x A 215mm
- Peso: 6KG
- Materiale:
ABS, nero



<p> Giravite PH PH.1, PH2, PH.3</p>	<p> Pinza regolabile 7" 180mm, 10" 250mm</p>	<p> Cutter</p>	<p> Set di chiavi combinate 14 pezzi</p>
<p> Giravite a spacco 3, 4,5,5, 6,5mm</p>	<p> Chiave a rullino 6" 155mm, 10" 250mm</p>	<p> flessometro 5 meter</p>	<p> Set di chiavi a bussola 1/4" 46 pezzi</p>
<p> Giravite TX T10, T15, T20, T25, T27, T30</p>	<p> Pinza spelafili 10" 250mm</p>	<p> Penna telescopica magnetica</p>	<p> Set di chiavi a bussola 1/4" 46 pezzi</p>
<p> Pinza universale 7", 180mm</p>	<p> Scalpello 160mm 12, 190mm 18</p>	<p> Mini torcia tascabile formato penna</p>	<p> Chiavi maschio Hex tonde extra lunghe 10 pezzi 1,27, 1,5, 2, 2,5, 3, 4, 5, 6, 8, 10mm</p>
<p> Pinza a becchi lunghi 8", 200mm</p>	<p> Punteruolo 185mm 3</p>	<p> Chiavi maschio TX extra lunghe 9 pezzi T10, T15, T20, T25, T27, T30, T40</p>	<p> Set di chiavi a bussola</p>
<p> Tronchese 6", 160mm</p>	<p> Martello 400gr</p>		



SPECIFICAMENTE PROGETTATA PER KARTING

SONIC

Art. 709601 **€ 544,22**
Cassettera attrezzata, **96 pezzi**



XS
472 X 202MM



Art. 709671 **€ 503,52**
Cassettera attrezzata con coperchio **96 pezzi**

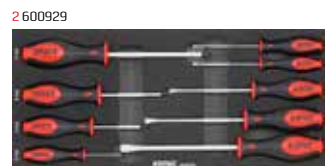
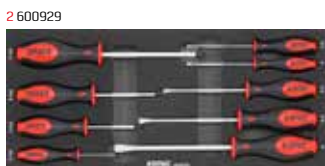

Art. 704721 **€ 511,92**
Cassettera attrezzata, **47 pezzi**

Art. 704771 **€ 452,75**
Cassettera attrezzata con coperchio **47 pezzi**



SOPRATTUTTO PER RIPARAZIONI MOTOCICLO

Art. 708971 **€ 657,22**
Cassettera attrezzata
89 Pezzi

XS
472 X 202MM



Art. 706201 **€ 451,68**
Cassettera attrezzata,
62 pezzi



Art. 715828 **€ 1284,36**
Cassettera attrezzata,
158 pezzi

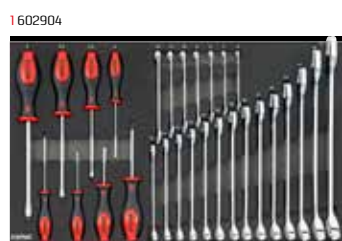

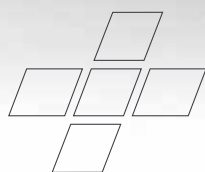

MSS+: Per lavori premium, flusso di lavoro definitivo

MSS+ è il nostro fiore all'occhiello quando si tratta di soluzioni di archiviazione modulari. Questa linea di prodotti di alta qualità è progettata per il vero professionista che non accetta niente di meno che il meglio. Il Sistema può essere costruito in modulare con una varietà di moduli, elementi e specifiche. La configurazione può essere corredata con gli utensili del Sonic Foam System (SFS). Questi termoformati in schiuma assicurano che gli utensili giusti, nella giusta composizione, siano disposti in modo efficiente nella configurazione. In questo modo si crea il posto di lavoro perfetto in ogni officina. Un flusso di lavoro definitivo e la massima soddisfazione sul lavoro garantiti.

S S S	M	L	XL
3X 1/3 190 X 370MM	1X 570 X 370MM	1X 745 X 435MM	1X 745 X 570MM



Sistema autoportante

- Compatibile con ogni area di lavoro - le pareti non servono più
- Progettato per resistere a un uso intensivo a lungo termine
- Tutti i moduli sono realizzati con una struttura in acciaio di alta qualità da 1,4 mm
- Facilmente regolabile in altezza
- Disponibile nel colore RAL 7016



Cassettiere

- Massima capacità di stoccaggio dei cassetti
- Meno sforzo sul cassetto e sul modulo, con conseguente maggiore durata
- Configurazioni multiple del cassetto disponibili
- Cassetti estraibili al 100%
- Maniglie ergonomiche per una presa perfetta
- I cassetti alti sono dotati di feritoie di ventilazione
- I cassetti inferiori includono una barra di alimentazione integrata con 2x USB e 4x 110V / 230V (armadi mobili esclusi)



123KG / 230KG

Guide

- Guide per carichi pesanti della più alta qualità disponibile sul mercato, con capacità di carico di 123 kg o 230 kg
- Sistema telescopico di guide su cuscinetti a sfere
- Massima affidabilità, precisione e conduzione regolare per l'intera vita del modulo MSS+

**Gli armadi a cassetti mobili sono dotati di guide per cassetti standard con una capacità di carico di 40 kg o 80 kg per cassetto.*



Sonic Foam Sistema

- Personalizza il contenuto del cassetto con l'esclusivo Sonic Foam System
- Organizzazione efficiente di set di utensili completi
- Sistema di colori a due tonalità della schiuma per una visione istantanea degli utensili mancanti
- Resistente all'olio e alle sostanze chimiche
- Specifiche degli utensili visibili sull'intarsio della schiuma



Cassettiere



5072001
[EU Presa di corrente]
720mm cassetiera, 8 cassetti

€ 1680,28



5072002
[EU Presa di corrente]
720mm cassetiera, 6 cassetti

€ 1478,56



5089001
[EU Steckdosenleiste]
890mm Schubladenschrank,
8 Schubladen

€ 1738,93



5089002
[EU Presa di corrente]
890mm cassetiera, 6 cassetti

€ 1600,55



5153901
[EU Presa di corrente]
1540mm cassetiera, 12 cassetti

€ 2720,78

Cassettiere portatile



5072004
700mm cassetiera portatile
extra profondo, 7 cassetti

€ 1414,33



5072005
700mm cassetiera portatile,
7 cassetti

€ 1034,55



5089004
870mm cassetiera portatile
extra profondo, 7 cassetti

€ 1590,76



5089005
870mm cassetiera portatile,
7 cassetti

€ 1180,11



5089011
890mm carrello di servizio

€ 388,78

Armadi



5036001
360mm armadio, porta sinistra
5036002
360mm armadio, porta destra

€ 578,85

€ 578,85



5072009
720mm armadio ad antina sinistra
5072010
720mm armadio ad antina destra

€ 751,97

€ 751,97



5089009
890mm armadio a doppia antina

€ 892,35



5106002
1060mm angolare, doppia anta

€ 1454,52

Armadio avvolgitubo

*Nur Halterung für Aufroller



5036003
360mm armadio avvolgitubo

€ 479,61



5072007
720mm armadio avvolgitubo

€ 594,48



5089007
890mm armadio avvolgitubo

€ 774,69



5071801
650mm armadio avvolgitubo alto

€ 1551,39



5071802
[EU Presa di corrente]
720mm pensile

€ 497,39

Pensili

Montante



5072003 **€ 912,76**
720mm cassettera, 5 cassetti



5089003 **€ 1008,41**
890mm cassettera 5 cassetti

- 5999401 Montante 50x50x1020mm **€ 23,05**
- 5999402 Montante 100x50x1020mm **€ 34,63**
- 5999405 Montante 50x50x1997mm **€ 42,23**
- 5999406 Montante 100x50x1997mm **€ 53,71**
- 5999403 Montante destro 100x50x1016mm per carrello portatile **€ 38,36**
- 5999404 Montante sinistro 100x50x1016mm per carrello portatile **€ 38,36**
- 5999407 Montante destro 100x50x1993mm per carrello portatile **€ 61,40**
- 5999408 Montante sinistro 100x50x1993mm per carrello portatile **€ 61,40**



5999937 **€ 66,64**
Pannello posteriore per unità ponte
720mm, 657x740mm

5999938 **€ 80,00**
Pannello posteriore per unità ponte
890mm, 827x740mm



Opzionale:

Gamma completa di colori su richiesta, tempi di consegna più lunghi e ulteriori tasse potrebbero applicare.



5072011 **€ 1043,73**
720mm armadio lavello con doppia anta



5072012 **€ 673,35**
720mm porta pattumiera



5089012 **€ 753,12**
890mm armadio portarifiuti



5065501 **€ 1335,69**
650mm armadio alto,
porta sinistra



5096501 **€ 1941,64**
965mm armadio,
doppia porta

5065502 **€ 1335,69**
650mm armadio alto,
porta destra



5082001 **€ 519,25**
(EU Presa di corrente)
820mm pensile



5089010 **€ 535,53**
(EU Presa di corrente)
890mm pensile



5072008 **€ 798,39**
(EU Presa di corrente)
720mm pensile con serracinesca



5089008 **€ 881,65**
(EU Presa di corrente)
890mm pensile con serracinesca



5072015 **€ 704,80**
619mm pensile con
portacomputer/laptop

Pannelli posteriori



Pannello pieno posteriore

- 5999901 259x50x120mm
- 5999902 619x50x120mm
- 5999903 719x50x120mm
- 5999904 789x50x120mm
- 5999930 959x50x120mm angolare

€ 15,31
€ 23,05
€ 26,81
€ 30,66
€ 42,23



Pannello pieno posteriore

- 5999913 259x50x552mm
- 5999905 619x50x552mm
- 5999906 719x50x552mm
- 5999907 789x50x552mm
- 5999931 959x50x552mm angolare

€ 29,99
€ 53,71
€ 57,47
€ 72,88
€ 88,20



Pannello pieno posteriore

- 5999908 259x50x1104mm
- 5999909 619x50x1104mm
- 5999910 719x50x1104mm
- 5999911 789x50x1104mm
- 5999934 959x50x1104mm angolare
- 5999912 619x50x1104mm pannello posteriore per monitor e tastiera

€ 61,40
€ 88,20
€ 99,66
€ 111,24
€ 149,51
€ 88,20



Pannello forato posteriore

- 5999922 259x50x552mm
- 5999923 619x50x552mm
- 5999924 719x50x552mm
- 5999925 789x50x552mm

€ 42,23
€ 65,28
€ 76,63
€ 84,45



Pannello forato posteriore

- 5999926 259x50x1104mm
- 5999927 619x50x1104mm
- 5999928 719x50x1104mm
- 5999929 789x50x1104mm
- 5999936 959x50x1104mm angolare

€ 80,50
€ 126,46
€ 141,90
€ 153,47
€ 161,09

Unità ponte



- 5070001 700mm Unità ponte
- 5072006 720mm Unità ponte
- 5089006 890mm Unità ponte
- 5106001 1060mm Unità ponte
- 5089013 890mm unità ponte con scrittoio

€ 110,50
€ 113,90
€ 127,50
€ 141,07
€ 238,91

Top

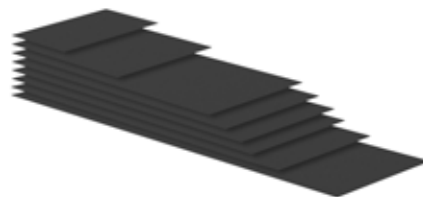

Top in acciaio inossidabile

- 5999801 360x650x2mm
- 5999802 720x650x2mm
- 5999803 890x650x2mm
- 5999804 1440x650x2mm (720+720mm)
- 5999805 1540x650x2mm
- 5999806 1610x650x2mm (720+890mm)
- 5999807 1780x650x2mm (890+890mm)
- 5999808 2160x650x2mm (720+720+720mm)

€ 11,60
€ 19,20
€ 23,05
€ 36,39
€ 38,36
€ 40,24
€ 45,97
€ 57,47

Spessore 20mm, profondità 650mm

Verbindungsplatten für fahrbare Schränke

- 5999021 863x655x2mm
- 5999043 686x523x2mm
- 5999044 856x523x2mm
- 5999045 693x655x2mm

€ 23,05
€ 14,23
€ 19,20
€ 17,20



Top in acciaio inossidabile

- 5999701 360x650x20mm
- 5999702 720x650x20mm
- 5999703 890x650x20mm
- 5999704 1441x650x20mm (720+720mm)
- 5999705 1540x650x20mm
- 5999706 1611x650x20mm (720+890mm)
- 5999707 1781x650x20mm (890+890mm)
- 5999708 2162x650x20mm (720+720+720mm)
- 5999711 2261x650x20mm (720+1540mm)
- 5999712 2332x650x20mm (720+720+890mm)
- 5999709 2431x650x20mm (890+1540mm)

€ 92,05
€ 153,47
€ 172,55
€ 287,63
€ 295,36
€ 302,97
€ 326,02
€ 414,22
€ 437,25
€ 444,86
€ 452,47

Spessore 20mm, profondità 650mm

Top in acciaio inossidabilen, carrello portatile

- 5999601 700x530x20mm
- 5999602 700x600x20mm
- 5999603 870x530x20mm
- 5999604 870x660x20mm

€ 122,71
€ 141,90
€ 138,03
€ 172,55

Spessore 20mm



Top angolare

- 5999809 Top in composito 1060x1060x2mm
- 5999710 Top in acciaio inossidabile 1060x1060x20mm

€ 38,36
€ 333,63



Top in legno

- 5999501 1780x650x40mm

€ 337,48

Spessore 40mm, profondità 650mm

Separatori

Illuminazione

Alimentazione elettrica



5999305

Il kit di separatori per cassetto da 720mm contiene:

- 3 pezzi MSS+ divisorio verticale (5999312)
- 2 pezzi MSS+ divisorio verticale per il lato (5999313)
- 2 pezzi MSS+ divisorio orizzontale (5999310)
- 4 pezzi MSS+ divisore orizzontale 88,60 mm (5999307)
- 4 pezzi MSS+ divisore orizzontale 182,30 mm (5999308)

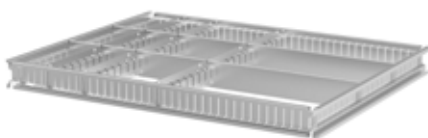

5999306

Il kit di separatori per cassetto da 890mm contiene:

- 3 pezzi MSS+ divisorio verticale (5999312)
- 2 pezzi MSS+ divisorio verticale per il lato (5999313)
- 2 pezzi MSS+ divisorio orizzontale (5999311)
- 4 pezzi MSS+ divisore orizzontale 88,60 mm (5999307)
- 4 pezzi MSS+ divisore orizzontale 182,30 mm (5999308)



5999318

Il kit di separatori per cassetto da 700mm contiene:

- 3 pezzi MSS+ divisorio verticale (5999314)
- 2 pezzi MSS+ divisorio verticale per il lato (5999315)
- 2 pezzi MSS+ divisorio orizzontale (5999310)
- 4 pezzi MSS+ divisore orizzontale 88,60 mm (5999307)
- 4 pezzi MSS+ divisore orizzontale 182,30 mm (5999308)



5999319

Il kit di separatori per cassetto della cassettiera estraibile da 870mm contiene:

- 3 pezzi MSS+ divisorio verticale (5999316)
- 2 pezzi MSS+ divisorio verticale per il lato (5999317)
- 2 pezzi MSS+ divisorio orizzontale (5999311)
- 4 pezzi MSS+ divisore orizzontale 88,60 mm (5999307)
- 4 pezzi MSS+ divisore orizzontale 182,30 mm (5999308)
- 2 pezzi MSS+ divisore orizzontale 369,76mm (5999309)



Luce LED di lunghezza 600mm

- 800-1000 Lm
- Temperatura colore: 6000-6500k
- Luce bianca
- Base in alluminio + coperchio per pc
- Magnete di montaggio incluso

Luce LED di lunghezza 800mm

- 800-1000 Lm
- Temperatura colore: 6000-6500k
- Luce bianca
- Base in alluminio + coperchio per pc
- Magnete di montaggio incluso



€ 75,29

• 5999201

MSS+ luce a LED, lunghezza 600mm

€ 26,47

• 5999202

MSS+ luce a LED, lunghezza 800mm

€ 29,44

• 5999204

MSS+ trasformatore per luce LED, spina EU

€ 53,71

• 5999205

MSS+ connettore con interruttore per luce LED

€ 5,73

• 5999206

MSS+ luce LED 600mm (EU) con trasformatore ed interruttore

€ 85,91

• 5999208

MSS+ luce LED 800mm (EU) con trasformatore ed interruttore

€ 88,88

Caratteristiche

- Trova ciò che stai cercando più velocemente, senza dover fare affidamento su altre luci intorno
- Viene utilizzata la tecnologia più recente
- Montaggio magnetico sotto il pensile
- Aumenta la tua produttività con una superficie di lavoro perfettamente illuminata
- Efficienza energetica ed estrema durata
- Collegamento massimo, circuito di 4 luci a LED



5999302 Alimentazione elettrica

€ 67,46

Le barre di potenza ad alte prestazioni MSS+ sono costruite in ABS e alluminio estruso anodizzato per garantire la massima durata.

Eigenschaften

- Resistente struttura in ABS rinforzata in alluminio
- 4 prese a terra
- 2 prese USB
- Interruttore reset / off illuminato
- Cavo da 5 m
- Corpo dal design ergonomico e profilato: robusto e facile da impugnare
- Robusta estrusione di alluminio anodizzato: leggera e resistente
- Prese e cappucci stampati in nylon Pa6 - proteggono e isolano Alimentazione elettrica
- Cavo in gomma policloropreen / neoprene di alta qualità (resistente a olio, sostanze chimiche e ozono)
- Colore RAL 7016

Nota

Gli armadi con cassetti fissi includono barra di alimentazione nel cassetto inferiore.

5999301 Staffa per barra di potenza

€ 18,36

- La staffa angolare della barra di alimentazione può essere montata sul pannello posteriore
- L'angolo rispetto alla staffa offre spazio per i cavi e la barra dei connettori
- La staffa della barra di alimentazione si trova all'interno della parte posteriore del palo, questo consente una soluzione di basso livello back-to-back

Portadocumenti

Porta laptop/notebook



5999061

Dimensioni: larghezza 560mm, profondità 40mm, altezza 314mm

- Pratico supporto per tablet / laptop o documenti
- Protezione di sicurezza su tutti i bordi
- Costruzione in acciaio di alta qualità da 1,0 mm

€ 34,63

5999304

Dimensioni: larghezza 447mm, profondità 158mm, altezza 365mm

- Pratico ripiano per tablet / laptop
- multifunzionale
- Funzione di inclinazione
- Montabile su pannelli posteriori
- Costruzione in acciaio di alta qualità da 1,2 mm

€ 84,45

Opzionale:

Gamma completa di colori su richiesta, tempi di consegna più lunghi e ulteriori tasse potrebbero applicare.



- 5770009 **Top in composito**
- 5771109 **Top in acciaio inossidabile**

Dimensioni: L 2160 x P 700 x A 1125mm

€ 3519,22
€ 3875,97



- 5770006 **Top in composito**
- 5771106 **Top in acciaio inossidabile**

Dimensioni: L 2690 x P 700 x A 1125mm

€ 3704,74
€ 4182,19



- 5770002 **Top in composito**
- 5771102 **Top in acciaio inossidabile**

Dimensioni: L 3580 x P 700 x A 1125mm

€ 5572,69
€ 6178,60



- 5770004 **Top in composito**
- 5771104 **Top in acciaio inossidabile**

Dimensioni: L 3150 x P 700 x A 1125mm

€ 5213,00
€ 5732,58



- 5770008 **Top in composito**
- 5771108 **Top in acciaio inossidabile**

Dimensioni: L 3340 x P 700 x A 1125mm

€ 5791,67
€ 6380,56



- 5770003 **Top in composito**
- 5771103 **Top in acciaio inossidabile**

Dimensioni: L 4040 x P 700 x A 1125mm

€ 6274,19
€ 6945,51



- 5770001 **Top in composito**
- 5771101 **Top in acciaio inossidabile**

Dimensioni: L 3600 x P 700 x A 1125mm

€ 5288,10
€ 5790,58



- 5770005 **Top in composito**
- 5771105 **Top in acciaio inossidabile**

Dimensioni: L 3220 x P 700 x A 1175mm

€ 8765,81
€ 9028,54



- 5771107 **Top in acciaio inossidabile**

Dimensioni: L 3390 x P 700 x A 1125mm
Dimensioni: L 1780 x P 700 x A 1125mm

€ 7293,27



- 5880010 **Top in composito**
- 5881110 **Top in acciaio inossidabile**

Dimensioni: L 2980 x P 700 x A 2000mm

€ 7087,79
€ 7473,21



- 5880003 **Top in composito**
- 5881103 **Top in acciaio inossidabile**

Dimensioni: L 3320 x P 700 x A 2000mm

€ 6636,45
€ 7173,50



- 5880004 **Top in composito**
- 5881104 **Top in acciaio inossidabile**

Dimensioni: L 4060 x P 700 x A 2000mm

€ 8734,53
€ 9346,25



- 5880008 **Top in composito** € 8465,22
- 5881108 **Top in acciaio inossidabile** € 9005,99

Dimensioni: L 4060 x P 700 x A 2000mm



- 5880002 **Top in composito** € 9167,48
- 5881102 **Top in acciaio inossidabile** € 9687,21

Dimensioni: L 4460 x P 700 x A 2000mm



- 5881106 **Top in acciaio inossidabile** € 9343,01

Dimensioni: L 3390 x P 700 x A 2105mm
Dimensioni: L 1780 x P 700 x A 1125mm



- 5880001 **Top in composito** € 8340,89
- 5881101 **Top in acciaio inossidabile** € 8935,31

Dimensioni: L 4060 x P 700 x A 2105mm



- 5880009 **Top in composito** € 15008,33
- 5881109 **Top in acciaio inossidabile** € 15790,45

Dimensioni: L 6790 x P 700 x A 2000mm



- 5660001 **Ripiano in legno** € 2607,87

Dimensioni: L 1780 x P 650 x A 1045mm



- 5880005 **Top in composito** € 11071,61
- 58811005 **Top in acciaio inossidabile** € 11854,07

Dimensioni: L 4760 x P 700 x A 2105mm

Configuratore 3D Sonic MSS+

La nostra app MSS+ 3D configuratore offre l'opportunità di creare un'immagine perfetta e personalizzata dell'officina. Saluta il flusso di lavoro definitivo.

Interessato? Contatta il nostro team di supporto Sonic o chiedi informazioni al tuo rivenditore Sonic abituale.

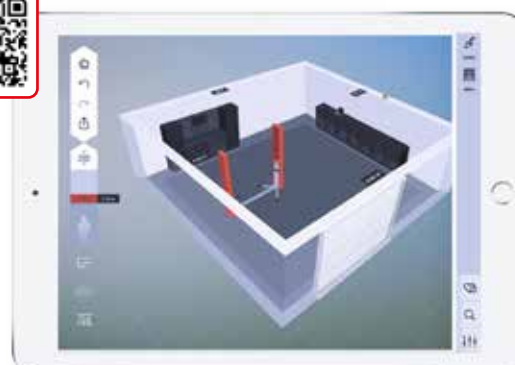



**WORK
EFFICIENT
WORK
WITH SONIC**



MSS:

Organizzatevi,
siate efficienti.

Assicuratevi di avere un ambiente di lavoro produttivo e flessibile con la nostra Sonic Modular Storage Solution (MSS). Questo sistema modulare è facile da montare, costruire ed espandere. Ciò significa che il MSS completamente autoportante può essere integrato in qualsiasi officina. Inoltre, MSS può essere completamente combinato con il nostro sistema di termoformati Sonic Foam System (SFS) per massimizzare la produttività e l'efficienza di ogni professionista.



3X 1/3 190 X 370MM



1X 570 X 370MM



745 X 435MM



Compatibile con
Sonic Foam System





PENSILE CON
MOLLE A GAS



ALTEZZA
REGOLABILE



€ 621,76

Art. 47280
674mm cassettera senza ripiano
Dimensioni: L 674 x P 500 x A 962mm
Dimensioni dei cassetti: L 575 x P 370mm
Altezza cassetto: 8x 74mm, 1x 153mm



€ 748,30

Art. 47296
845mm cassettera senza ripiano
Dimensioni: L 845 x P 500 x A 962mm
Dimensioni dei cassetti: L 745 x P 435mm
Altezza cassetto: 8x 74mm, 1x 153mm



€ 548,06

Art. 47647
674mm cassettera senza ripiano
Dimensioni: L 674 x P 500 x A 962mm
Dimensioni dei cassetti: L 575 x P 370mm
Altezza cassetto: 5x 153mm



€ 563,09

Art. 47640
674mm cassettera senza ripiano
Dimensioni: L 674 x P 500 x A 962mm
Dimensioni dei cassetti: L 575 x P 370mm
Altezza cassetto: 2x 74mm, 1x 145mm, 2x 230mm



€ 497,49

Art. 47308
674mm cassettera senza ripiano,
3 cassetti e 1 antina
Dimensioni: L 674 x P 500 x A 962mm
Dimensioni dei cassetti: L 575 x P 370mm
Altezza cassetto: 4x 74mm



€ 627,78

Art. 47379
845mm cassettera senza ripiano,
3 cassetti e 1 antina
Dimensioni: L 845 x P 500 x A 962mm
Dimensioni dei cassetti: L 745 x P 435mm
Altezza cassetto: 4x 74mm



€ 399,46

Art. 47288
674mm armadietto senza ripiano
Dimensioni: L 674 x P 500 x A 962mm



€ 468,42

Art. 47302
845mm armadietto senza ripiano
Dimensioni: L 845 x P 500 x A 962mm



€ 647,83

Art. 47432
674mm armadietto due ante con lavello
Rubinetto non incluso
Dimensioni: L 674 x P 500 x A 962mm



€ 535,80

Art. 47450
674mm armadietto portarifiuti senza ripiano
Dimensioni: L 674 x P 500 x A 962mm



€ 575,52

Art. 47431
674mm armadietto portarifiuti senza ripiano
Dimensioni: L 674 x P 500 x A 962mm



€ 536,59

Art. 47649
674mm cestino con porta rotolo
Dimensioni: L 674 x P 500 x A 962mm



€ 702,22

Art. 47272
610mm armadio, 5 ripiani
Dimensioni: L 610 x P 530 x A 2000mm



€ 950,45

Art. 47433
914mm armadio a 2 ante, 4 ripiani
Dimensioni: L 914 x P 530 x A 2000mm



€ 623,92

Art. 47451
674mm cassettera 7 cassetti con ruote
Dimensioni: L 674 x P 500 x A 947mm
Altezza cassetto: 5x 74mm, 2x 153mm



€ 762,57

Art. 47600
845mm Armadietto per avvolgicavo
e avvolgitubo, senza ripiano.
Avvolgicavo e avvolgitubo non inclusi
Dimensioni: L 845 x P 500 x A 962mm



€ 173,92

Art. 47276
674mm pensile
L 674 x P 300 x A 400mm



€ 357,95

Art. 47650
845mm pensile angolare
L 1263 x P 300 x A 400mm



€ 265,07

Art. 47544
Ripiano in legno per armadietto 47505



Ripiano in legno

Art. 47378 B 674 x T 500 x H 40mm
Art. 47382 B 845 x T 500 x H 40mm
Art. 47279 B 1348 x T 500 x H 40mm
Art. 47295 B 1690 x T 500 x H 40mm
Art. 47306 B 2193 x T 500 x H 40mm

€ 112,85
€ 159,03
€ 268,50
€ 285,12
€ 308,23



€ 201,18

Art. 47292
845mm pensile
L 845 x P 300 x A 400mm



€ 814,14

Art. 47505
845mm armadietto angolare Senza
piano di lavoro
L 877 x P 877 x A 962mm



€ 275,02

Art. 47545
Ripiano in acciaio inox per armadietto 47505



Ripiano in acciaio inox

Art. 47377 B 674 x T 500 x H 38mm
Art. 47381 B 845 x T 500 x H 40mm
Art. 47383 B 1348 x T 500 x H 40mm
Art. 47384 B 1690 x T 500 x H 40mm
Art. 47385 B 2193 x T 500 x H 40mm

€ 129,47
€ 156,02
€ 209,04
€ 241,92
€ 288,50



€ 64,67

Art. 47376
674mm pannello
euroforo

€ 80,88

Art. 47380
845mm pannello
euroforo

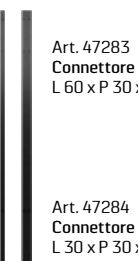

€ 29,21

Art. 47283
Connettore
L 60 x P 30 x A 2000mm

€ 21,49

Art. 47284
Connettore
L 30 x P 30 x A 2000mm



€ 21,18

Art. 47772
Distanziale per piano di lavoro
MSS extra profondo.



Piano di lavoro profondo in acciaio inox *(extra profondo)*

Art. 47447 B 1348 x T 570 x H 38mm
Art. 47448 B 1690 x T 570 x H 38mm
Art. 47449 B 2193 x T 570 x H 38mm

€ 218,86
€ 255,21
€ 304,83



Art. 47415
MSS ganci a 45° (prezzo per pezzo)
Dimensioni: 50mm

€ 3,04



Art. 47416
MSS ganci rotondi (prezzo per pezzo)
Dimensioni: ø40mm

€ 3,36

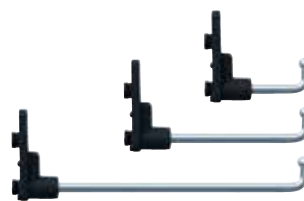

Art. 47419
MSS ganci a 90° (prezzo per pezzo)
Dimensioni: 50mm

€ 3,20

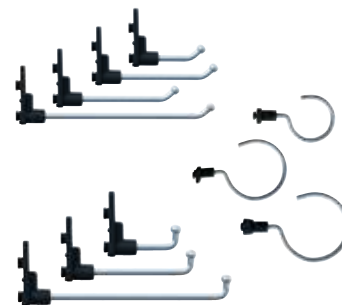

Art. 47420
MSS ganci a 90° (prezzo per pezzo)
Dimensioni: 90mm

€ 3,36

Art. 47290
MSS ganci a 45° (prezzo per pezzo)
Dimensioni: 90mm

€ 3,20

Art. 47291
MSS ganci a 45° (prezzo per pezzo)
Dimensioni: 150mm

€ 3,36

Art. 47417
MSS ganci rotondi (prezzo per pezzo)
Dimensioni: ø60mm

€ 5,04

Art. 47418
MSS ganci rotondi (prezzo per pezzo)
Dimensioni: ø80mm

€ 6,71

Art. 47421
MSS ganci a 90° (prezzo per pezzo)
Dimensioni: 150mm

€ 3,68

Art. 47632
MSS set di ganci, 10 pezzi

€ 37,91



Art. 47638
MSS supporto per pinze

€ 13,58



Art. 47639
MSS supporto per giraviti

€ 15,65



Art. 482159
Contenitore vuoto per fascette per MSS

€ 39,64

Art. 482158
Contenitore con fascette per MSS

€ 61,96

Art. 482151
2x fascette 3,6 x 140mm; 100 pezzi

Art. 482152
2x fascette 3,6 x 180mm; 100 pezzi

Art. 482153
2x fascette 4,8 x 220mm; 100 pezzi

Art. 482155
2x fascette 4,8 x 280mm; 100 pezzi

Art. 482157
2x fascette 4,8 x 370mm; 100 pezzi



Art. 4720101
Portaminuteria per cassetto a 5 scompartimenti
Dimensioni:
L 370 x P 145 x A 48mm

€ 3,90



Art. 4720102
Portaminuteria per cassetto a 5 scompartimenti
Dimensioni:
L 370 x P 145 x A 48mm

€ 3,90



Art. 4720103
Portaminuteria per cassetto a 8 scompartimenti
Dimensioni:
L 370 x P 290 x A 48mm

€ 6,56



Art. 4720104
Portaminuteria per cassetto a 12 scompartimenti
Dimensioni:
L 370 x P 290 x A 48mm

€ 6,56



Art. 4720105
Portaminuteria per cassetto a 18 scompartimenti
Dimensioni:
L 370 x P 290 x A 48mm

€ 6,56



Art. 4820524
MSS luce a LED con regolatore di luminosità

€ 28,90

- Lunghezza 600mm
- 400-500 lumen
- Temperatura di colore: 6000-6500K
- Luce bianca
- Base in alluminio + copertura in PVC
- Cavo lungo 1,8m con interruttore nel mezzo
- Connettore USB con adattatore
- Magnetici per il montaggio sull'MSS inclusi



SGO

Art. 5999201
Luce a LED, lunghezza 600mm

€ 26,47

Art. 5999202
Luce a LED, lunghezza 800mm

€ 29,44

Art. 5999204
Trasformatore per luce Led, spina EU

€ 53,71

Art. 5999205
Connettore con interruttore per luce LED

€ 5,73

Art. 5999206
Luce LED 600mm (EU) con trasformatore ed interruttore

€ 85,91

Art. 5999208
Luce LED 800mm (EU) con trasformatore ed interruttore

€ 88,88



SGO

Art. 5999302
Alimentazione elettrica

€ 67,46

Le barre di potenza ad alte prestazioni sono costruite in ABS e alluminio estruso anodizzato per garantire la massima durata.

Art. 5999301
Staffa per barra di potenza

€ 18,36

- La staffa per sbarre ad angolo può essere fissata alla parete posteriore
- La staffa alla staffa offre spazio per le anime dei cavi e le strisce di connessione
- La staffa per sbarre sul retro della guida del cavo consente una semplice soluzione back-to-back.

PIANO DI LAVORO EXTRA PROFONDO TRAMITE DISTANZIATORE



Art. 4730196 - Ripiano in legno

€ 2586,86

Art. 4731196 - Top in acciaio inossidabile

€ 2531,38

Dimensioni: L 1958 x P 530 x A 2000mm

Art. 4732196 - Piano di lavoro extra profondo in acciaio inox

€ 2616,38

Dimensioni: L 1958 x P 600 x A 2000mm



Art. 4730230 - Ripiano in legno

€ 2861,39

Art. 4731230 - Top in acciaio inossidabile

€ 2821,12

Dimensioni: L 2300 x P 530 x A 2000mm

Art. 4732230 - Piano di lavoro extra profondo in acciaio inox

€ 2909,31

Dimensioni: L 2300 x P 600 x A 2000mm



Art. 4730281 - Ripiano in legno

€ 3545,80

Art. 4731281 - Top in acciaio inossidabile

€ 3527,38

Dimensioni: P 2803 x P 530 x A 2000mm

Art. 4732281 - Piano di lavoro extra profondo in acciaio inox

€ 3614,48

Dimensioni: L 2803 x P 600 x A 2000mm

PIANO DI LAVORO A SBALZO EXTRA PROFONDO IN ACCIAIO INOX



Art. 4731819 - Top in acciaio inossidabile

€ 3966,86

Dimensioni: L 3107 x P 600 x A 2000mm



Art. 4731517 - Ripiano in legno

€ 3455,08

Art. 4731817 - Top in acciaio inossidabile

€ 3436,69

Dimensioni: L 2803 x P 530 x A 2000mm



Art. 4731509 - Ripiano in legno

€ 3901,93

Art. 4731809 - Top in acciaio inossidabile

€ 3883,52

Dimensioni: L 2803 x P 530 x A 2000mm

PIANO DI LAVORO A SBALZO EXTRA PROFONDO IN ACCIAIO INOX



Art. 4731713 - Top in acciaio inossidabile

€ 3113,68

Dimensioni: L 2604 x P 600 x A 2000mm



Art. 4731401 - Ripiano in legno

€ 3116,02

Art. 4731701 - Top in acciaio inossidabile

€ 3075,74

Dimensioni: L 2300 x P 530 x A 2000mm



Art. 4731301 - Ripiano in legno

€ 2814,83

Art. 4731601 - Top in acciaio inossidabile

€ 2759,36

Dimensioni: L 1958 x P 530 x A 2000mm



Art. 4731513 - Ripiano in legno

€ 2183,12

Art. 4731813 - Top in acciaio inossidabile

€ 2154,67

Dimensioni: L 2193 x P 530 x A 2000mm



Art. 4731511 - Ripiano in legno

€ 1763,69

Art. 4731811 - Top in acciaio inossidabile

€ 1745,31

Dimensioni: L 2193 x P 530 x A 2000mm



Art. 4731501 - Ripiano in legno

€ 2284,01

Art. 4731801 - Top in acciaio inossidabile

€ 2265,62

Dimensioni: L 2193 x P 530 x A 2000mm



Art. 4731402 - Ripiano in legno
Art. 4731702 - Top in acciaio inossidabile
Dimensioni: L 1690 x P 500 x A 2000mm

€ 1415,00
€ 1376,00



Art. 4731403 - Ripiano in legno
Art. 4731703 - Top in acciaio inossidabile
Dimensioni: L 1690 x P 500 x A 2000mm

€ 1652,00
€ 1613,00



Art. 4731302 - Ripiano in legno
Art. 4731602 - Top in acciaio inossidabile
Dimensioni: L 1348 x P 500 x A 2000mm

€ 1243,00
€ 1190,00



Art. 4731516 - Ripiano in legno
Art. 4731816 - Top in acciaio inossidabile
Dimensioni: L 2193 x P 500 x A 1002mm

€ 1494,00
€ 1476,00



Art. 4731505 - Ripiano in legno
Art. 4731805 - Top in acciaio inossidabile
Dimensioni: L 2193 x P 500 x A 1002mm

€ 1600,00
€ 1582,00



Art. 4731506 - Ripiano in legno
Art. 4731806 - Top in acciaio inossidabile
Dimensioni: L 2193 x P 500 x A 1002mm

€ 1805,00
€ 1787,00



Art. 4731507 - Ripiano in legno
Art. 4731807 - Top in acciaio inossidabile
Dimensioni: L 2193 x P 500 x A 1002mm

€ 1715,00
€ 1697,00



Art. 4731508 - Ripiano in legno
Art. 4731808 - Top in acciaio inossidabile
Dimensioni: L 2193 x P 500 x A 1002mm

€ 1920,00
€ 1902,00



Art. 4731510 - Ripiano in legno
Art. 4731810 - Top in acciaio inossidabile
Dimensioni: L 2193 x P 500 x A 1002mm

€ 1204,00
€ 1186,00



Art. 4731404 - Ripiano in legno
Art. 4731704 - Top in acciaio inossidabile
Dimensioni: L 1690 x P 500 x A 1002mm

€ 1461,00
€ 1422,00



Art. 4731405 - Ripiano in legno
Art. 4731705 - Top in acciaio inossidabile
Dimensioni: L 1690 x P 500 x A 1002mm

€ 1224,00
€ 1184,00



Art. 4731306 - Ripiano in legno
Art. 4731606 - Top in acciaio inossidabile
Dimensioni: L 1348 x P 500 x A 1002mm

€ 1078,00
€ 1024,00



€ 149,92

Art. 203703
Set di bussole e chiavi da 3/8",
BMCS 37 pezzi



€ 84,98

€ 117,06

€ 213,84



Art. 104602
Set di chiavi a bussola a cricchetto
da 1/4", BMCS 46 pezzi

Art. 204003
Set di chiavi a bussola a cricchetto
da 3/8", BMCS 40 pezzi

€ 165,71

€ 103,71



Art. 206102
Set di chiavi a bussola e chiavi maschio
da 3/8", BMCS 61 pezzi

Art. 301904
Set di chiavi a bussola da 1/2",
BMCS 19 pezzi



Art. 304501
Set di bussole e chiavi da 1/2",
BMCS 45 pezzi



€ 193,00

Art. 306701
Set di chiavi, chiavi a bussola, chiavi maschio, inserti e giraviti da 1/4" e 1/2", BMCS 67 pezzi



Alta qualità e resistenza del guscio, impugnatura bicolore e chiusure metalliche. Gli utensili sono alloggiati in schiume laminare dal design molto accattivante.

€ 208,16

€ 233,42

€ 234,06

€ 336,59



Art. 307603
Set di chiavi a bussola da 1/4" e 1/2", BMCS 76 pezzi

Art. 309101
Set di chiavi a bussola, chiavi maschio ed inserti da 1/4" e 1/2", BMCS 91 pezzi

Art. 309402
Set di chiavi a bussola, chiavi maschio ed inserti da 1/4" e 1/2", BMCS 94 pezzi

Art. 309901
Set di chiavi a bussola, chiavi maschio ed inserti da 1/4" e 1/2", BMCS 99 pezzi

€ 204,58

€ 51,02

€ 37,87

€ 40,19



Art. 101105
Set TPMS, BMCS 11 pezzi

Art. 301702
Set di chiavi a bussola a giravite Torx da 1/2", BMCS 17 pezzi

Art. 300817
Set di chiavi a bussola a giravite Torx da 1/2", BMCS 8 pezzi

Art. 300819
Set di chiavi a bussola a giravite Spline da 1/2", BMCS 8 pezzi



**WORK
EFFICIENT
WORK
WITH SONIC**



Sets su binari



Sonic ha una vasta gamma di inserti per tutte le necessita' da 1/4", 3/8" e 1/2".
Tutti gli Inserti su binari sono ben organizzati, facili da appendere o da inserire nei cassetti.

Tutta la gamma puo' essere visionata sul sito oppure sul catalogo

6.3 10
1/4" 3/8"

€ 44,46

6.3 10
1/4" 3/8"

€ 37,36

6.3 10 12.5
1/4" 3/8" 1/2"

€ 27,53





















































Art. 200805
Set di chiavi a bussola 1/4" e 3/8" Porsche,
su binario 8 pezzi
- 10mm

Art. 201015
Set di chiavi a bussola 1/4" e 3/8" per Volkswagen/Audi, su
binario 10 pezzi
- 10, 13mm
- Esagonali 5, 6mm
- T20, T25, T30
- M6, M8, M10

Art. 300814
Serie di 8 adattatori e snodi cardanici su binario
- 1/4" (F) x 6mm (F) - 1/2" (F) x 3/8" (M)
- 1/4" (F) x 3/8" (M) - 3/8" (F) x 1/2" (M)
- 3/8" (F) x 1/4" (M)



<p>6.3 1/4"</p>  <p>€ 32,67</p>  <p>Art. 101204 Set di chiavi a bussola profilo flank lunghe 1/4", su binario 12 pezzi - 4, 4.5, 5, 5.5, 6, 7, 8, 9, 10, 11, 12, 13mm</p>	<p>6.3 1/4"</p>  <p>€ 21,04</p>  <p>Art. 101201 Set di chiavi a bussola 12 pt. 1/4", su binario 12 pezzi - 4, 4.5, 5, 5.5, 6, 7, 8, 9, 10, 11, 12, 13mm</p>	<p>6.3 1/4"</p>  <p>€ 31,54</p>  <p>Art. 101202 Set di chiavi a bussola lunghe 12 pt. 1/4", su binario 12 pezzi - 4, 4.5, 5, 5.5, 6, 7, 8, 9, 10, 11, 12, 13mm</p>	<p>6.3 1/4"</p>  <p>€ 25,06</p>  <p>Art. 101002 Set di chiavi a bussola TX-E 1/4", su binario 10 pezzi - E5, E6, E7, E8, E10 corto - E5, E6, E7, E8, E10 lungo</p>
<p>6.3 1/4"</p>    <p>€ 17,64</p>  <p>Art. 100901 Set di chiavi a bussola 1/4", (SAE) su binario 9 pezzi - 3/16", 7/32", 1/4", 9/32", 5/16", 11/32", 3/8", 7/16", 1/2"</p>	<p>6.3 1/4"</p>    <p>€ 25,63</p>  <p>Art. 100902 Set di chiavi a bussola lunghe 1/4", (SAE) su binario 9 pezzi - 3/16", 7/32", 1/4", 9/32", 5/16", 11/32", 3/8", 7/16", 1/2"</p>	<p>6.3 1/4"</p>  <p>€ 25,25</p>  <p>Art. 100904 Set di chiavi a bussola a giravite Hex 1/4", (SAE) su binario 9 pezzi - 3, 4, 5, 5.5, 6, 7, 8, 9, 10mm</p>	<p>6.3 1/4"</p>    <p>€ 19,86</p>  <p>Art. 100702 Set di chiavi a bussola a giravite Hex 1/4", (SAE) su binario 7 pezzi - 1/8", 5/32", 3/16", 7/32", 1/4", 5/16", 3/8"</p>
<p>6.3 1/4"</p>   <p>€ 26,10</p>  <p>Art. 101004 Set di chiavi a bussola a giravite TX 1/4", su binario 10 pezzi - TX 1/4", T8, T10, T15, T20, T25 - TX tamper 1/4", T8H, T10H, T15H, T20H, T25H</p>	<p>6.3 1/4"</p>  <p>€ 24,54</p>  <p>Art. 100704 Set di chiavi a bussola a giravite TX con punta sferica 1/4", su binario 7 pezzi - T10, T15, T20, T25, T27, T30, T40</p>	<p>6.3 1/4"</p>  <p>€ 20,76</p>  <p>Art. 100701 Set di chiavi a bussola a giravite TX 1/4" a 5 lobi, su binario 7 pezzi - 10IPR, 15IPR, 20IPR, 25IPR, 27IPR, 30IPR, 40IPR</p>	<p>6.3 1/4"</p>  <p>€ 27,42</p>  <p>Art. 101005 Set di chiavi a bussola a giravite TX tamper 1/4", su binario 10 pezzi - 8IPR, 10IPR, 15IPR, 20IPR, 25IPR, 27IPR, 30IPR, 40IPR, 45IPR, 50IPR</p>
<p>10 3/8"</p>  <p>€ 23,83</p>  <p>Art. 201001 Set di chiavi a bussola 3/8", su binario 10 pezzi - 8, 9, 10, 11, 12, 13, 14, 15, 16, 17mm</p>	<p>10 3/8"</p>  <p>€ 37,59</p>  <p>Art. 201008 Set di chiavi a bussola profilo flank lunghe 6 pt. 3/8", su binario 10 pezzi - 8, 9, 10, 11, 12, 13, 14, 15, 16, 17mm</p>	<p>10 3/8"</p>  <p>€ 22,79</p>  <p>Art. 201009 Set di chiavi a bussola profilo flank 12 pt. 3/8", su binario 8 pezzi - 8, 10, 11, 12, 13, 14, 15, 16, 17, 19mm</p>	<p>10 3/8"</p>  <p>€ 36,46</p>  <p>Art. 201010 Set di chiavi a bussola profilo flank lunghe 12pt. 3/8", su binario 10 pezzi - 8, 10, 11, 12, 13, 14, 15, 16, 17, 19mm</p>
<p>10 3/8"</p>  <p>€ 32,72</p>  <p>Art. 201002 Set di chiavi a bussola TX-E 3/8", su binario 10 pezzi - E10, E11, E12, E14, E16 Corto - E10, E11, E12, E14, E16 Lungo</p>	<p>10 3/8"</p>    <p>€ 20,95</p>  <p>Art. 200801 Set di chiavi a bussola 3/8", (SAE) su binario 8 pezzi - 3/8", 7/16", 1/2", 9/16", 5/8", 11/16", 3/4", 13/16"</p>	<p>10 3/8"</p>    <p>€ 32,39</p>  <p>Art. 200802 Set di chiavi a bussola lunghe 3/8", (SAE) su binario 8 pezzi - 3/8", 7/16", 1/2", 9/16", 5/8", 11/16", 3/4", 13/16"</p>	<p>10 3/8"</p>  <p>€ 35,18</p>  <p>Art. 201003 Set di chiavi a bussola a giravite Hex 3/8" su binario 10 pezzi - 3, 4, 5, 5.5, 6, 7, 8, 9, 10, 12mm</p>



Art. 200903
Set di chiavi a bussola a giravite Hex lunghe 3/8", su binario 9 pezzi
- 90mm 3, 4, 5, 5.5, 6, 7, 8, 9, 10mm

€ 34,47



Art. 200902
Set di chiavi a bussola a giravite Hex punta sferica 3/8", (SAE) su binario 9 pezzi
- 3/8", 1/8", 5/32", 3/16", 7/32", 1/4", 5/16", 3/8", 7/16", 1/2"

€ 31,44



Art. 201005
Set di chiavi a bussola a giravite TX 3/8", su binario 10 pezzi
- T8, T10, T15, T20, T25, T27, T30, T40, T45, T50

€ 37,73



Art. 201006
Set di chiavi a bussola a giravite TX tamper 3/8", su binario 10 pezzi
- T8H, T10H, T15H, T20H, T25H, T27H, T30H, T40H, T45H, T50H

€ 39,62

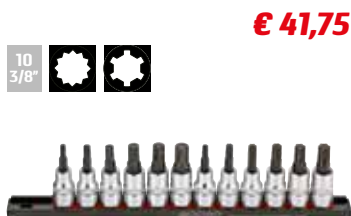

Art. 201201
Set di chiavi a bussola a giravite ribe e triple square 3/8", su binario 12 pezzi
- Spline M5, M6, M8, M9, M10, M12
- Ribs M5, M6, M7, M8, M9, M10

€ 41,75



Art. 301007
Set di chiavi a bussola 1/2", su binario 10 pezzi
- 11, 12, 13, 14, 15, 17, 19, 21, 22, 24mm

€ 29,62



Art. 301201
Set di chiavi a bussola 12 pt. 1/2", su binario 12 pezzi
- 8, 9, 10, 11, 12, 13, 14, 15, 16, 17, 18, 19mm

€ 35,42



Art. 301202
Set di chiavi a bussola lunghe 1/2", su binario 12 pezzi
- 8, 9, 10, 11, 12, 13, 14, 15, 16, 17, 18, 19mm

€ 57,63

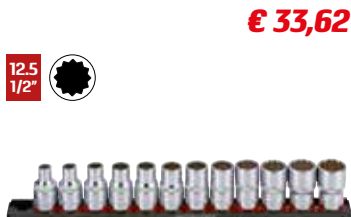

Art. 301203
Set di chiavi a bussola 12 pt 1/2", su binario 12 pezzi
- 8, 9, 10, 11, 12, 13, 14, 15, 16, 17, 18, 19mm

€ 33,62



Art. 301204
Set di chiavi a bussola lunghe 12 pt. 1/2", su binario 12 pezzi
- 8, 9, 10, 11, 12, 13, 14, 15, 16, 17, 18, 19mm

€ 56,12



Art. 300902
Set di chiavi a bussola TX-E 1/2", su binario 9 pezzi
- E10, E11, E12, E14, E16, E18, E20, E22, E24

€ 30,31



Art. 301503
Set di chiavi a bussola 1/2", (SAE) su binario 15 pezzi
- 3/8", 7/16", 1/2", 9/16", 5/8", 11/16", 3/4", 13/16", 7/8", 15/16", 1", 1.1/16", 1.1/8", 1.3/16", 1.1/4"

€ 62,12



Art. 301003
Set di chiavi a bussola a giravite Hex 1/2", su binario 10 pezzi
- 4, 5, 5.5, 6, 7, 8, 9, 10, 12, 14mm

€ 45,39



Art. 301002
Set di chiavi a bussola a giravite Hex 1/2", (SAE) su binario 10 pezzi
- 3/16", 1/4", 9/32", 5/16", 11/32", 3/8", 7/16", 1/2", 9/16", 5/8"

€ 45,82



Art. 301005
Set di chiavi a bussola a giravite TX 1/2", su binario 10 pezzi
- T20, T25, T27, T30, T40, T45, T50, T55, T60, T70

€ 45,06



Art. 300906
Set di chiavi a bussola a giravite spline 1/2", su binario 9 pezzi
- M5, M6, M8, M9, M10, M12, M14, M16
- M16-T

€ 46,99



Art. 200907
Set di chiavi a bussola corte a giravite Hex 3/8", su binario 9 pezzi
- 4, 5, 6, 7, 8, 9, 10, 11, 12mm

€ 35,26



Art. 201016
Set di chiavi a bussola corte a giravite Star 3/8", su binario 10 pezzi
- T10, T15, T20, T25, T27, T30, T40, T45, T50, T55

€ 35,22



Power Lights



€ 46,37

SGO

Art. 4820515
Lampada MAG LED portatile

- 3 Magneti
- La testa della lampada si inclina a 180 gradi
- Due ganci di sospensione regolabili ed estraibili
- Batteria ad alta capacità ricaricabile 1200 mAh agli ioni di litio
- 7x SMD LED (luce principale)
- Faretto a LED ad alta potenza
- Worklight: 120 lumen
- Spotlight: 50 lumen
- L'intensità della luce di lavoro: 250 lux a 0,5 m
- Luce Spotlight intensità: 500 lux a 0,5 m
- Luce di funzionamento di lavoro a tempo: 4 ore
- Tempo di funzionamento in primo piano: 4 ore
- 4 Ore per la ricarica
- Include caricabatterie 220V e USB
- Protezione IP20



€ 44,83

SGO

Art. 4820516
Lampada Miniform COB LED + 1W ultra slim

- COB LED
- Emissione di luce 2 step
- 2,5 ore per la ricarica
- Batteria ad alta capacità ricaricabile 1000 mAh agli ioni di litio
- 180° Con magnete
- Gancio girevole
- Fase 1: 55 lumen
- Fase 2: 110 lumen
- 1: 130 lux a 0,5 m
- 2: 260 lux a 0,5 m
- Il tempo di funzionamento step 1: 5 ore
- Tempo di funzionamento step 2: 2,5 ore
- Tempo di ricarica: 2,5 ore
- Caricabatterie 220V e USB
- Peso: 112g
- Protezione IP20



€ 65,30

SGO

Art. 4820517
Lampada Miniform COB LED + 1W

- Lampada professionale da lavoro per ispezioni ad alta luminosità di luce a 120° grazie a COB-LED
- Tempo ricarica in 3 ore
- Batteria ricaricabile al Litio-polimeri 1600 mAh
- Indicatore di carica
- Base pieghevole con potente magnete a 180°
- LED a 2 step d'intensità di luce 120 lumen/250 lumen
- Intensità luce: 100 lux a 0,5m/340 lux a 0,5m
- Autonomia batteria circa 3 ore
- Fornita con caricabatteria 220V e cavo USB
- Peso 160g
- Protezione IP20



€ 73,31

SGO

Art. 4820518
Torcia frontale i-view

- La luce grazie a 2 COB LED potenti si diffonde intorno a tutto il campo visivo, non si deve più girare la testa per illuminare lo spazio di lavoro
- Accensione e spegnimento mediante sensore sensibile al movimento della mano, da indossare sul capo o sopra l'elmetto
- LED a 2 step d'intensità: 125 lumen / 250 lumen
- 300 lux a 0,5 m
- 500 lux a 0,5 m
- Autonomia batteria circa 6 ore
- Batteria ricaricabile al Litio-polimeri
- Protezione ip 65
- Fornita con adattatore 100-240V AC e cavo USB
- Tempo di ricarica 4 ore
- Peso 140 g



€ 26,26

SGO

Art. 4821105
Mini torcia tascabile formato penna

- Livello di luminosità 1100 lux
- Tempo di funzionamento fino a 8 ore
- Fascio di luce fino a 75 m
- 2x Batteria AAA inclusa
- Impermeabile (IP54)
- Scatola regalo inclusa



€ 44,22

SGO

Art. 4821102
Lampada torcia MAG LED portatile + 5W

- Tempo di funzionamento fino a 4 ore
- Tempo di ricarica 4 ore
- Luce principale con 21 LED ad alta luminosità
- Caricabatteria 230V AC / 50Hz
- 3,7V / 1200mAh Li-on batteria ricaricabile
- Resiste a temperature da -10 a + 40 ° C
- Peso 0.30 kg



Power Lights

€ 56,89



GGO

- Art. 4820519
3-in-1 torcia slim (mini)
- COB LED/spot: high power LED
 - Step 1/2
 - 150/400 lux@0.5M
 - Spot: 5200 lux@0.5M
 - 100/200 lumen
 - Spot: 100 lumen
 - Tempo di funzionamento: 2.5/5 Ore
 - Tempo di ricarica: 3 ore
 - 3.7V/1200 mAh li-ion
 - Protezione IP30

€ 64,38



GGO

- Art. 4820520
3-in-1 torcia slim
- COB LED/spot: high power LED
 - Step 1/2
 - 400/800 lux@0.5m
 - Spot: 4800 lux@0.5m
 - 250/500 lumen
 - Spot: 100 lumen
 - Tempo di funzionamento 2.5/5 Ore
 - 4 Tempo di ricarica: 4,5 Ore
 - 3.8V/2800 mAh li-ion
 - Protezione IP30

- Art. 4820513
Lampada da ispezione 8W
- Tensione nominale 230V ~ 50-60 Hz
 - Cavo principale 5 m 2x0,75 mm²
 - Non a prova di esplosione

€ 19,00



GGO



GGO

€ 213,52

- Art. 4821106
Faretto nova 30W COB LED
- Nuovo ed innovativo faretto COB progettato con il nuovo LED di ultima generazione! Il corpo è realizzato in alluminio pressofuso protetto da un robusto telaio in gomma. La durata estrema della lampada combinata con la lunga durata del LED rende NOVA 'Una lampada per tutta la vita'.
 - Il supporto flessibile permette di posizionare la lampada ovunque si desideri.
 - Cavo 5m [2x1,0mm²]
 - 30W COB LED
 - 3300 lumen
 - 500 lux a 50 cm



Sollevatori



€ 572,74



- Art. 48032
Sollevatore alluminio, 2 t
- Massima capacità di sollevamento: 2000kg
 - Altezza minima di sollevamento: 83mm
 - Altezza massima di sollevamento: 470mm
 - Lunghezza totale: 632mm
 - Diametro piatto di raccolta: 108mm



€ 273,12



- Art. 48031
Aluminium + Stahl Wagenheber 1,5t
- Massima capacità di sollevamento: 1500kg
 - Altezza minima di sollevamento: 88mm
 - Altezza massima di sollevamento: 360mm
 - Lunghezza totale: 484mm
 - Diametro piatto di raccolta: 108mm

Sollevatore idraulico in alluminio. Il sollevatore è dotato di ruote in nylon (2 ruote girevoli), un'asta di manovra in due parti e una maniglia per il trasporto. Il sollevatore viene fornito con un cuscinetto in gomma.



€ 306,43



- Art. 48034
Wagenheber, flache Ausführung, 3t
- Massima capacità di sollevamento: 3000kg
 - Altezza minima di sollevamento: 75mm
 - Altezza massima di sollevamento: 505mm
 - Lunghezza totale: 673mm
 - Diametro piatto di raccolta: 108mm



€ 392,32



- Art. 48035
Wagenheber, flache Ausführung, extra lang 1.5t
- Massima capacità di sollevamento: 1500kg
 - Altezza minima di sollevamento: 70mm
 - Altezza massima di sollevamento: 610mm
 - Lunghezza totale: 863mm
 - Diametro piatto di raccolta: 108mm



€ 291,87



- Art. 48033
Wagenheber, flache Ausführung, 2t
- Massima capacità di sollevamento: 2000kg
 - Altezza minima di sollevamento: 75mm
 - Altezza massima di sollevamento: 505mm
 - Lunghezza totale: 675mm
 - Diametro piatto di raccolta: 108mm

Sollevatore idraulico, particolarmente adatto per veicoli commerciali leggeri. Il martinetto è dotato di ruote in nylon (2 ruote piroettanti) e pedale supplementare. Inoltre, il sollevatore ha un'asta di manovra in due parti con maniglia e una copertura protettiva in schiuma. Il martinetto viene fornito con un cuscinetto in gomma e una ciotola extra per materiale di piccole dimensioni.



€ 497,93



Art. Nr. 4822331

Gru da officina, 1 Ton

Il braccio dispone di 3 posizioni di sollevamento.

Dimensioni piegato: L 1499 x B 90 x H 1405mm



POSIZIONE	CAPACITÀ	ALTEZZA MINIMA	ALTEZZA MASSIMA
1	1000kg	334mm	2120mm
2	750kg	214mm	2210mm
3	500kg	94mm	2300mm



€ 252,16



Art. 4822332

Carrello portapneumatici

Questo carrello leggero utilizza un sistema di sollevamento brevettato che permette ai montatori di pneumatici di manovrare facilmente e nel modo più ergonomico grosse quantità di pneumatici. Sistema di bloccaggio automatico realizzato in acciaio inox. Garanzia 3 anni. Peso 17 kg. Possibilità di trasportare pneumatici da 13" a 20" e pesi fino a 200 kg.



€ 399,20



Art. 4800708

Sollevatore idraulico per trasmissione 500kg

Sollevatore professionale da fossa per montaggio e smontaggio di cambi e scatole di rinvio. Questa versione da 500 kg ha ruote girevoli in nylon per una facile manovrabilità. Il sollevatore è dotato di un comando a pedale a sollevamento rapido. Grazie alla testa di presa reversibile, il sollevatore è multifunzionale.



€ 42,28



Art. 4800707

Coppia di cavalletti, 3 t

Cavalletto con una capacità di 3 tonnellate per il supporto sicuro di vari veicoli e altri oggetti pesanti. Altezza minima 305 mm, massima 450 mm.



€ 22,62



Art. 480025

Scherenwagenheber

- Capacità di carico: 1 t
- Altezza min. 90 mm
- Altezza max. 330 mm



€ 22,21

€ 27,60

€ 32,98

€ 38,40

€ 48,16

€ 65,50

Martinetti idraulici compatti, per sollevare diversi tipi di veicoli e altri oggetti pesanti



Art. 4800701

Martinetto idraulico, 2 t

Capacità di sollevamento di 2 tonnellate.

L'altezza di sollevamento minima è di 158 mm, la massima è di 308 mm



Art. 4800702

Martinetto idraulico, 4 t

Capacità di sollevamento di 4 tonnellate.

L'altezza di sollevamento minima è di 180 mm, la massima è di 350 mm.



Art. 4800703

Martinetto idraulico, 6 t

Capacità di sollevamento di 6 tonnellate.

L'altezza di sollevamento minima è di 197 mm, la massima è di 382 mm.



Art. 4800704

Martinetto idraulico, 8 t

Capacità di sollevamento di 8 tonnellate.

L'altezza di sollevamento minima è di 205 mm, la massima è di 390 mm.



Art. 4800705

Martinetto idraulico, 12 t

Capacità di sollevamento di 12 tonnellate.

L'altezza di sollevamento minima è di 215 mm, la massima è di 400 mm.



Art. 4800706

Martinetto idraulico, 20 t

Capacità di sollevamento di 20 tonnellate.

L'altezza di sollevamento minima è di 244 mm, la massima è di 449 mm.



Booster Sonic.

Potente booster per professionisti e uso intensivo.

€ 259,20



GGO

- Art. 48132
Booster portatile MINI 12V/440CA
- voltaggio: 12V
 - avviamento amps: 440A
 - picco amps: 1600A
 - lunghezza cavo: 60cm
 - sezione cavo: 25mm²
 - morsetti: 600A
 - caricatore AC/DC: 1,3 a con indicatore di carica
 - fusibili per batteria: 300A
 - peso: 6,5kg
 - Dimensioni: 360 x 130 x 240mm

€ 433,23



GGO

- Art. 48150
Booster 12V/800CA
- Batteria AGM ad alta capacità
 - Avviamento amps: 800CA
 - Cavi: rame puro, doppio isolamento 155 cm / 25 mm
 - Caricabatteria: Automatico 12V 1.3A
 - Voltmetro analogico
 - Presa 12V DC (ingresso e uscita)
 - Fusibile 300A di protezione da cortocircuito
 - Morsetti heavy duty
 - Involucro in plastica rotostampata infrangibile - Peso: 9,5kg
 - Dimensioni: 375 x 110 x 320 mm



€ 612,27

GGO

- Art. 48149
Booster Giga Lithium 12V/800CA
- Batteria: Lito LiFePO4 (4 celle)
 - Avviamento amps: 800CA
 - Cavi: rame puro, 50 cm / 10 mm
 - Caricabatteria: automatico 12V 1.3A
 - Display digitale con indicatori LED
 - Protezione completa contro l'inversione di polarità, cortocircuiti, sovratensione, sovraccarico, sovratemperatura, sovrascarica
 - Dotato di una funzione di risparmio della memoria
 - Morsetti heavy duty
 - Peso: 2,5 kg
 - Dimensioni: 260 x 135 x 72 mm

€ 1094,54

GGO

- Art. 48151
Booster 12V/24V 1600/800CA
- Batterie AGM ad alta capacità (2)
 - Avviamento amps: 1600 / 800CA
 - Cavi: rame puro, doppio isolamento 135 cm / 35 mm
 - Caricabatteria: Automatico 12V 4A - Voltmetro analogico
 - Presa 12V DC (solo uscita)
 - Connettori Anderson per selezione tensione (12 / 24V)
 - Allarme di inversione di polarità
 - Fusibile da 300A di protezione da cortocircuito
 - Morsetti heavy duty curvi a 45° con luce LED in morsetto blu
 - Involucro in plastica rotostampata infrangibile
 - Peso: 20,5kg
 - Dimensioni: 530 x 160 x 480 mm



€ 89,38

GGO

- Art. 48152
Stazione di ricarica per 48149



Propulstation® Sempre pronto a far partire



GGO



€ 746,24

- Art. 48116
Propulstation con stazione di ricarica per officina/casa 12V/800CA
- voltaggio: 12V
 - avviamento amps: 800A
 - picco amps: 2370A
 - Lunghezza cavo: 155cm
 - sezione cavo: 35mm²
 - morsetti: 650A
 - Incluso montaggio a parete/caricabatteria

GGO



€ 2249,68

- Art. 48122
Propulstation con stazione di ricarica per officina/casa 24V/1200CA
- voltaggio: 12V
 - avviamento amps: 1200A
 - picco amps: 3100A
 - Lunghezza cavo: 135cm
 - sezione cavo: 50mm²
 - morsetti: 850A
 - Incluso montaggio a parete/caricabatteria



Avvolgicavo e avvolgitubo

**CORRENTE ELETTRICA****SGO****€ 442,08**

Art. 4822411

- Avvolgicavo con cavi di ricarica 6 metri
- Riavvolgimento automatico a mezzo molla
- Involucro esterno in plastica
- Staffa da parete girevole in acciaio
- Dispositivo di arresto a cricchetto facilmente ispezionabile e rimovibile dall'utente finale
- Diametro tubo 16 mm
- 30A
- Approvato CE
- Certificato TÜV

Made in Italy

**SGO****SISTEMA SLOW MOTION:**

Il sistema slow motion garantisce un movimento fluido e privo di strappi impedendo danni agli oggetti e/o agli operatori. Questo sistema è disponibile ed applicabile su tutti gli avvolgicavo e avvolgitubo, può essere montato facilmente all'esterno della custodia, anche dopo l'installazione.

ART.	DESCRIZIONE	
4822407	Sistema slow motion per avvolgitubo 4822401	€ 25,47
4822408	Sistema slow motion per avvolgitubo 4822402	€ 25,47
4822409	Sistema slow motion per avvolgitubo 4822405	€ 25,47
4822410	Sistema slow motion per avvolgitubo 4822403	€ 25,47

**CORRENTE ELETTRICA****€ 172,37****SGO**

Art. 4822401

Avvolgicavo da 18 metri

- Avvolgimento automatico a mezzo molla
- Sistema slow motion: avvolge lentamente il flessibile, senza scuoterlo, in modo da garantire una graduale ritrazione sicura in caso di scivolamento accidentale
- Involucro esterno in plastica
- Staffa girevole a muro in acciaio
- Dispositivo di arresto a scatto facilmente ispezionabile e rimovibile dall'utente finale
- Cavo da 3 x 1,5mm²
- Con cavo in bobina avente capacità max. Di 800 w
- Con cavo srotolato con capacità max. Di 200w
- Certificazione CE
- Certificazione TÜV

**€ 111,72****SGO**

Art. 4822402

Avvolgitubo aria compressa 9m, Ø8mm, Max. 10 Bar

- Avvolgimento automatico a mezzo molla
- Sistema slow motion: avvolge lentamente il flessibile, senza scuoterlo, in modo da garantire una graduale ritrazione sicura in caso di scivolamento accidentale
- Involucro esterno in plastica
- Staffa girevole a muro in acciaio
- Dispositivo di arresto a scatto facilmente ispezionabile e rimovibile dall'utente finale
- Raccordo da 1/4"
- Diam. Del flessibile di 8 mm
- Max. Pressione di esercizio 10 bar
- Tubo in poliuretano lucido
- Certificazione CE



ARIA

**€ 129,28****SGO**

Art. 4822403

Avvolgitubo aria compressa 12m, Ø8mm, Max. 15 Bar

- Avvolgimento automatico a mezzo molla
- Sistema slow motion: avvolge lentamente il flessibile, senza scuoterlo, in modo da garantire una graduale ritrazione sicura in caso di scivolamento accidentale
- Involucro esterno in plastica
- Staffa girevole a muro in acciaio
- Dispositivo di arresto a scatto facilmente ispezionabile e rimovibile dall'utente finale
- Raccordo da 1/4"
- Diam. Del flessibile di 8 mm
- Max. Pressione di esercizio 15 bar
- Tubo in poliuretano lucido
- Certificazione CE



ARIA



ARIA

**€ 129,28****SGO**

Art. 4822404

Avvolgitubo aria compressa 8m, Ø10mm, Max. 15 Bar

- Avvolgimento automatico a mezzo molla
- Sistema slow motion: avvolge lentamente il flessibile, senza scuoterlo, in modo da garantire una graduale ritrazione sicura in caso di scivolamento accidentale
- Involucro esterno in plastica
- Staffa girevole a muro in acciaio
- Dispositivo di arresto a scatto facilmente ispezionabile e rimovibile dall'utente finale
- Raccordo da 3/8"
- Diam. Del flessibile di 10 mm
- Max. Pressione di esercizio 15 bar
- Tubo in poliuretano lucido
- Certificazione CE

**€ 154,01****SGO**

Art. 4822405

Avvolgitubo aria compressa 15m, Ø8mm, Max. 15 Bar

- Avvolgimento automatico a mezzo molla
- Sistema slow motion: avvolge lentamente il flessibile, senza scuoterlo, in modo da garantire una graduale ritrazione sicura in caso di scivolamento accidentale
- Involucro esterno in plastica
- Staffa girevole a muro in acciaio
- Dispositivo di arresto a scatto facilmente ispezionabile e rimovibile dall'utente finale
- Raccordo da 1/4"
- Diam. Del flessibile di 8 mm
- Max. Pressione di esercizio 15 bar
- Tubo in poliuretano lucido
- Certificazione CE



ARIA

**€ 176,36****SGO**

Art. 4822406

Avvolgitubo aria compressa 14+1m, Ø10mm, Max. 15 Bar

- Avvolgimento automatico a mezzo molla
- Sistema slow motion: avvolge lentamente il flessibile, senza scuoterlo, in modo da garantire una graduale ritrazione sicura in caso di scivolamento accidentale
- Involucro esterno in plastica
- Staffa girevole a muro in acciaio
- Dispositivo di arresto a scatto facilmente ispezionabile e rimovibile dall'utente finale
- Raccordo da 3/8"
- Diam. Del flessibile di 10 mm
- Max. Pressione di esercizio 15 bar
- Tubo in poliuretano lucido
- Certificazione CE



ARIA



€ 52,61



Art. 601906
Set di giraviti flessibili, 19 pezzi



Art. 47536 € 11,00
Giravite a bussola flessibile esagonale 6 mm

Art. 47537 € 11,31
Giravite a bussola flessibile esagonale 7 mm

Art. 47538 € 11,00
Giravite a bussola flessibile esagonale 8 mm

€ 20,31



Art. 600618
Set di giraviti, 6 pezzi
- 3, 4, 5,5, 6,5mm, PH1, PH2

€ 23,15



Art. 600619
Set di giraviti, 6 pezzi
- T10, T15, T20, T25, T27, T30

€ 24,41



Art. 600620
Set di giraviti TX-H, 6 pezzi
- T10H, T15H, T20H, T25H, T27H, T30H

€ 76,67



Art. 602006
Set di giraviti, 20 pezzi
- PH.1, PH.2, PH.3, - PZ.1, PZ.2, PZ.3,
- 3, 4, 5,5, 6,5, 8mm - T10, T15, T20, T25, T27, T30

€ 11,87



Art. 600439
Set di ganci verticali, 4 pezzi

€ 4,40



Art. 17320002
Giravite per elettronica 2 mm

€ 24,04



Art. 601408
Impugnatura a cricchetto
14 in 1, con 8 inserti
- 4, 4.5, 5mm
- PH.1, PH.2, PH.3
- PZ.1, PZ.2
- T10, T15, T20, T25mm

€ 29,16



Art. 600514
Set di giraviti a battere, 5 pezzi
- PH.1, PH.2, 5,5, 6,5, 8mm



Art. 13625015
Giravite extra lungo, T15

€ 7,44

Art. 13625020
Giravite extra lungo, T20

€ 7,44

Art. 13625025
Giravite extra lungo, T25

€ 8,37

Art. 13625027
Giravite extra lungo, T27

€ 8,37

Art. 13625030
Giravite extra lungo, T30

€ 8,37

Art. 13625040
Giravite extra lungo, T40

€ 8,68

Art. 13625045
Giravite extra lungo, T45

€ 10,13



Art. 1312502
Giravite extra lungo, PH.2

€ 7,60

Art. 13325004
Giravite extra lungo, 4mm

€ 6,00

Art. 13325055
Giravite extra lungo, 5,5mm

€ 7,34

Art. 13325065
Giravite extra lungo, 6,5mm

€ 8,94



Art. 1342503
Giravite extra lungo, Hex 3mm

€ 6,00

Art. 1342504
Giravite extra lungo, Hex 4mm

€ 7,85

Art. 1342505
Giravite extra lungo, Hex 5mm

€ 8,37

Art. 1342506
Giravite extra lungo, Hex 6mm

€ 9,50

EXTRA LUNGHE 545MM



Art. 4753701
Giravite flessibile Hex 7mm

€ 16,06



€ 60,99



€ 82,10



Art. 601401
Set di chiavi combinate con custodia, 14 pezzi
6, 7, 8, 9, 10, 11, 12, 13, 14, 15, 16, 17, 19, 22mm

Art. 601702
Set di chiavi combinate con custodia, 17 pezzi
6, 7, 8, 9, 10, 11, 12, 13, 14, 15, 16, 17, 18, 19, 20, 21, 22mm



€ 154,81



€ 181,94



Art. 601219
Set di chiavi combinate a cricchetto doppia reversibile 12pt. con custodia, 12 pezzi
8, 9, 10, 11, 12, 13, 14, 15, 16, 17, 18, 19mm

Art. 601218
Set di chiavi a cricchetto doppia snodata 12pt. con custodia, 12 pezzi
8, 9, 10, 11, 12, 13, 14, 15, 16, 17, 18, 19mm



€ 172,33



Art. 600507
Set di chiavi a forchetta doppia snodata, 5 pezzi
8, 9, 10, 11, 12mm



€ 57,55



€ 53,40

Art. 602603
Set di chiavi combinate con custodia, 26 pezzi
6, 7, 8, 9, 10, 11, 12, 13, 14, 15, 16, 17, 18, 19, 20, 21, 22, 23, 24, 25, 26, 27, 28, 29, 30, 32mm



Art. 600203
Set di chiavi a cricchetto 4 in 1 con custodia, 2 pezzi
- 4 in 1 chiavi combinate 8-10, 12-13 mm
- 4 in 1 chiavi combinate 16-17, 18-19 mm



€ 22,35

Queste chiavi hanno un profilo adattato sul lato corto e curvo. Questa impronta assicura una migliore ripartizione della forza e previene danni all'incavo esagonale durante l'allentamento o il serraggio del bullone. Un magnete è montato nella testa della sfera sul lato lungo, rendendo più facile rimuovere o inserire il bullone in punti difficili da raggiungere. Questo set di chiavi è un "must have" per il tecnico moderno!



Art. 600931
Set di chiavi maschio piegate special Hex punta sferica, extra lunghe 9 pezzi
1.5, 2, 2.5, 3, 4, 5, 6, 8, 10mm



€ 17,29



Art. 601003
Set di chiavi maschio piegate Hex extra lunghe, (SAE) 10 pezzi
1/16", 5/64", 3/32", 1/8", 5/32", 3/16", 7/32", 1/4", 5/16", 3/8"



€ 15,89

Art. 600902
Set di chiavi maschio piegate TX extra lunghe, 9 pezzi
T10, T15, T20, T25, T27, T30, T40, T45, T50



€ 9,50

Art. 600831
Set di chiavi maschio Hex lunghe, 8 pezzi
2, 2.5, 3, 4, 5, 6, 8, 10mm



€ 13,55

Art. 601006
Set di chiavi maschio piegate Hex punta sferica lunghe, 10 pezzi
1.27, 1.5, 2, 2.5, 3, 4, 5, 6, 8, 10mm



€ 13,83

Art. 601007
Set di chiavi maschio Hex extra lunghe 10 pezzi
1.27, 1.5, 2, 2.5, 3, 4, 5, 6, 8, 10mm



€ 18,25

Art. 601008
Set di chiavi maschio Hex extra lunghe punta sferica, 10 pezzi
1.27, 1.5, 2, 2.5, 3, 4, 5, 6, 8, 10mm



- MAGNETICO
- DIMENSIONI
ESTREMAMENTE
GRANDI

€ 69,68



Art. 601305
Set di chiavi maschio piegate Hex con testa sferica con magnete, 13 pezzi
2, 2.5, 3, 4, 5, 6, 7, 8, 10, 12, 14, 17, 19mm



- MAGNETICO
- DIMENSIONI
ESTREMAMENTE
GRANDI

€ 69,68



Art. 601306
Set di chiavi maschio piegate Hex con testa sferica con magnete, (SAE) 13 pezzi
5/64", 3/32", 1/8", 5/32", 3/16", 7/32", 1/4", 5/16", 3/8", 1/2", 9/16", 5/8", 3/4"



- MAGNETICO
- DIMENSIONI
ESTREMAMENTE
GRANDI

€ 81,61



Art. 601307
Set di chiavi maschio piegate TX a 5 punte con magnete, 13 pezzi
T10, T15, T20, T25, T27, T30, T40, 45, T50, T55, T60, T70, T80



€ 19,39



€ 30,54

**EXTRA LANG
600MM**



€ 34,36

**EXTRA LANG
600MM**

Art. 600912
Set di chiavi maschio piegate Hex a punta sferica nane,
9 pezzi
1,5, 2, 2,5, 3, 4, 5, 6, 8, 10mm

Art. 600621
Set di chiavi maschio piegate 600mmL,
6 pezzi
4, 5, 6, 7, 8, 10mm

Art. 600622
Set di chiavi maschio piegate TX a 5 punte 600mmL,
6 pezzi
T20, T25, T30, T40, T45, T50



€ 12,37



€ 15,33

Art. 600923
Set di chiavi maschio piegate Hex extra
lunghe con testa sferica colorate, 10 pezzi
1,5, 2, 2,5, 3, 4, 5, 6, 8, 10mm

Art. 600924
Set di chiavi maschio piegate TX a 5 punte
nane colorate, 9 pezzi.
T10, T15, T20, T25, T27, T30, T40, T45, T50



€ 45,76



€ 16,47



€ 20,21

Art. 600925
Set di chiavi maschio piegate Hex extra
lunghe colorate, 9 pezzi
1,5, 2, 2,5, 3, 4, 5, 6, 8, 10mm

Art. 600926
Set di chiavi maschio piegate TX extra
lunghe a 5 punte colorate, 9 pezzi
T10, T15, T20, T25, T27, T30, T40, T45, T50

Art. 601908
Set di chiavi maschio gemelle, hex ballpoint e tamper star, 19 pezzi
1,5, 2, 2,5, 3, 4, 5, 6, 8, 10mm,
T10, T15, T20, T25, T27, T30, T40, T45, T50



€ 5,85



€ 6,56



€ 6,38

Art. 600712
Set tascabile di chiavi
maschio Hex, 7 pezzi
2, 2,5, 3, 4, 5, 6, 8mm

Art. 600716
Set tascabile di chiavi maschio
Hex punta sferica, 7 pezzi
2,5, 3, 4, 5, 6, 8, 10mm

Art. 600830
Set tascabile di chiavi maschio
TX a 5 punte, 8 pezzi
T8, T10, T15, T20, T25, T27, T30, T40



€ 43,24



€ 41,66



€ 24,75

Art. 4411001

Rivettatrice

- Capacità: M6 acciaio M5 acciaio inox
- Fornito con 3 dadi: M3-M4-M5
- Molto confortevole, può essere usata con entrambe le mani

Art. 4411002

Rivettatrice

- Capacità: diam 6,4 mm per rivetti in alluminio
- Capacità: diam 6 mm per rivetti in acciaio
- Assorbe l'impatto quando il rivettoscatta
- Fornito con 4 nasi diametri 4-5-6-6,4 mm e chiave di bloccaggio

Art. 4411003

Rivettatrice

- Con naso di tipo nuovo per una durata più lunga
- Molla di ritorno
- Fornito con 3 nasi e una chiave di bloccaggio.
- Capacità: 0,5 mm alluminio e 0,4 mm acciaio.



€ 171,83



Art. 813002

Set di pinza a cricchetto per capicorda

Con ganasce intercambiabili, 11 pezzi

- Set di utensili crimpatori con cricchetto
- Ganasce operative e regolabili
- Comprende 10 ganasce crimpatrici intercambiabili
- Capicorda isolati din 0,5-6 mm²
- Capicorda non isolati din 1,5-10 mm²
- Estremità terminali tamburo aperto din 0,5-4,0 mm²
- Terminale capocorda isolato din 0,5-6 mm²
- (Per misure piccole)
- Terminale di estremità cavo isolato
- Din 0,5-6 mm² (per misure grandi)
- Terminale tamburo aperto e d-sub, v3,5
- Connettore del cavo (bnc)
- Connettore 4p4c
- Connettore 6p6c
- Connettore 8p8c

€ 76,11



Art. 4474002

Pinze per pesi adesivi di bilanciamento delle ruote

Per rimuovere i pesi adesivi per cerchi in lega. Grazie al suo design unico alla base, si possono rimuovere tutti i tipi di pesi adesivi molto facilmente e senza danneggiare i cerchi in lega



€ 10,78



Art. 600308

Set di morsetti per flessibili di linea, 3 pezzi



€ 26,63

Art. 813003

Pinza per capicorda 0,2-0,6mm 200l

- Ideali per cavi con doppio isolamento
- Separano l'isolamento anche centralmente, per banchi di saldatura
- Per pressacavi di pressatura isolati e non e ig



€ 40,39

Art. 4471180

Pinza spelafili automatica 0,5-4mm

- Con fermo regolabile in lunghezza per spelatura isolante 8-12 mm
- Tagliacavo con diametro di 2 mm
- Ritensione in spazi ridotti e protezione della lama di taglio



Sicurezza, durata e resistenza

I nostri martelli Sonic sono creati per sopportare un utilizzo pesante.

 Made in Italy



- Art. 4611200 Martello da meccanico 200gr. con manico in legno lunghezza 287mm Peso 262gr **€ 8,54**
- Art. 4611400 Martello da meccanico 400gr. con manico in legno lunghezza 311mm Peso 512gr **€ 11,02**
- Art. 4640500 Martello da meccanico 500gr. con manico in legno lunghezza 347mm Peso 630gr **€ 11,98**
- Art. 4640600 Martello da meccanico 600gr. con manico in legno lunghezza 360mm Peso 760gr **€ 14,05**
- Art. 4640800 Martello da meccanico 800gr. con manico in legno lunghezza 383mm Peso 994gr **€ 16,05**
- Art. 4621000 Martello da meccanico 1000gr. con manico in legno lunghezza 366mm Peso 1166gr **€ 18,76**
- Art. 4641500 Martello da meccanico 1500gr. con manico in legno lunghezza 422mm Peso 1672gr **€ 23,47**
- Art. 4642000 Martello da meccanico 2000gr. con manico in legno lunghezza 447mm Peso 2170gr **€ 27,78**



Art. 4822503 Schlosserhammer, englische Form mit Holzgriff Länge 320mm Gewicht 454g

€ 11,03



Art. 4631000 Mazzetta con manico in fibra di vetro e rivestimento TPR 1000gr lunghezza 278mm Peso 1106gr

€ 14,86



Art. 4822102 Mazzetta con battenti in materiale plastico 35mm lunghezza 97mm Peso 366gr
Art. 4620400 Mazzetta 400gr lunghezza 290mm Peso 608gr

€ 22,51

€ 25,31

€ 40,46



Art. 4342200 Tronchese regolabile 8"

€ 39,90



Art. 4342240 Tronchese a taglienti diagonali 9"

€ 38,63



Art. 4312200 Pinza a becchi semitondi multifunzione 8"



€ 69,11



Art. 600322 Set di pinze 3 pezzi

€ 94,16



Art. 600440 Set di pinze 4 pezzi



- Art. 4351180 Pinza regolabile 7", 180mm **€ 21,15**
- Art. 4351250 Pinza regolabile 10", 250mm **€ 16,29**
- Art. 4351300 Pinza regolabile 12", 300mm **€ 37,11**
- Art. 4351400 Pinza regolabile 15", 400mm **€ 55,47**



- Art. 4352180 Pinza regolabile MX, 7", 180mm **€ 28,50**
- Art. 4352250 Pinza regolabile MX, 10", 250mm **€ 32,25**
- Art. 4352300 Pinza regolabile MX, 12", 300mm **€ 38,79**
- Art. 4352400 Pinza regolabile MX, 15", 400mm **€ 79,64**



Cricchetto Sonic generazione futura!

Vi presentiamo il nostro nuovissimo cricchetto Sonic, NEXT!

Il cricchetto Sonic NEXT è il più potente della gamma. Ha un design ergonomico estremo che fornisce un contatto ottimale e quindi una maggiore trasmissione della forza, fino a 757 Nm. I 60 denti del cricchetto NEXT assicurano più precisione ed efficienza.

Inoltre, la testa stretta del cricchetto Sonic NEXT offre la possibilità di raggiungere anche gli spazi più ristretti.



Art.	Definizione	Peso(g)	Lunghezza	Larghezza	Altezza	Nm
7121501	1/4" cricchetto 60-denti	90	147	21	20	90
7121502	3/8" cricchetto 60-denti	214	195	28	28	300
7121503	1/2" cricchetto 60-denti	492	260	37	35	757



€ 63,54

Art. 7121403
Cricchetto estensibile 1/2", 36-denti

Art. 7110301
Cricchetto "Svita tutto" da 1/4", 72 denti

€ 10,14

Art. 7110302
Cricchetto "Svita tutto" da 3/8", 72 denti

€ 10,69

Art. 7110303
Cricchetto "Svita tutto" da 1/2", 72 denti

€ 11,77

Art. 300313
Set cricchetto palmare 1/4", 3 pezzi

€ 27,20



Art. 7110801
Cricchetto flessibile 1/4", 45 denti con sistema di bloccaggio



€ 29,44

Art. 7110802
Cricchetto flessibile 3/8", 45 denti con sistema di bloccaggio



€ 36,60

Art. 7110803
Cricchetto flessibile 1/2", 45 denti con sistema di bloccaggio



€ 43,92



Rotazione a 360°



Art. 72601
Chiave a T da 1/4"

€ 33,23

Art. 72602
Chiave a T da 3/8"

€ 40,21

Art. 72603
Chiave a T da 1/2"

€ 46,48

Cricchetto con impugnatura rotante



Art. 7121101
Cricchetto con impugnatura rotante da 1/4"

€ 53,77

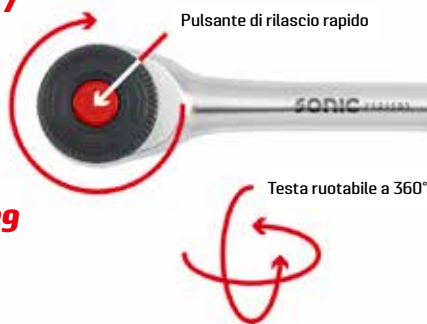

Azionamento con torsione dell'impugnatura

€ 72,40

Azionamento standard

- Ideale per spazi di manovra angusti
- Pulsante per il rilascio rapido



Art. 7121102
Cricchetto con impugnatura rotante da 3/8"

€ 59,89

Art. 7121103
Cricchetto con impugnatura rotante da 1/2"



Art. 7120101
Cricchetto nano 1/4", 45-denti

€ 25,93



Art. 7120901
Cricchetto 1/4", 45-denti

€ 26,83



Art. 7110101
Cricchetto flessibile 1/4", 45-denti

€ 29,90

Art. 7120102
Cricchetto nano 3/8", 45-denti

€ 30,26

Art. 7120902
Cricchetto 3/8", 45-denti

€ 31,79

Art. 7110102
Cricchetto flessibile 3/8", 45-denti

€ 37,07



Art. 7120701
Cricchetto 1/4", 72-denti

€ 20,88



Art. 7110201
Cricchetto rotante 1/4", 72-denti

€ 26,38



Art. 7110402
Cricchetto rotante nano 3/8", 72-denti

€ 28,91

Art. 7120702
Cricchetto 3/8", 72-denti

€ 26,65

Art. 7110202
Cricchetto rotante 3/8", 72-denti

€ 34,05

Art. 7110403
Cricchetto rotante nano 1/2", 72-denti

€ 33,51

Art. 7120703
Cricchetto 1/2", 72-denti

€ 33,87

Art. 7110203
Cricchetto rotante 1/2", 72-denti

€ 39,91

€ 82,93



Art. 100602

Set di mini cricchetti, 5 pezzi

Questo set di cricchetti manuali è composto da tre cricchetti, adatti per inserti da 10 mm, da 5/16 e da 1/4. I cricchetti possono essere utilizzati anche per normali bussole con attacco da 1/2", 3/8" e 1/4" utilizzando l'adattatore in dotazione. Questo adattatore può essere riposto nell'impugnatura del cricchetto.

€ 56,68



Art. 7233605

Cricchetto girevole 1/2" 45T, 600mmL

Questa impugnatura è dotata di una testa a cricchetto a 45 denti. Ciò aumenta la facilità d'uso della maniglia. La testa con cricchetto è disponibile anche separatamente. (Art. 7233602)



Chiave dinamometrica



PESO LEGGERO



Sonic offre chiavi dinamometriche con due tipi di connessioni:
La connessione fissa e la squadra passante (svolta a sinistra ea destra).
Offre una gamma totale da 1/4" a 1" jack, da 5 Nm a 1000 Nm.



SCALA BEN VISIBILE
IN Nm E FT.LB



INSERIMENTO DIRETTO DEL MOVIMENTO
SINISTRO-DESTRO CON IL SISTEMA DI
SGANCIO RAPIDO SONIC



SISTEMA DI BLOCCO
LETTURA SONIC A PRESSIONE,
RAPIDO, ACCURATO, SICURO



CONFORTEVOLE AZIONAMENTO
ERGONOMICO



SCALA CHIARAMENTE VISIBILE

Art. 73210525	€ 98,66
Chiave dinamometrica da 1/4", 5-25Nm	
Art. 73220550	€ 116,19
Chiave dinamometrica da 3/8", 10-50Nm	
Art. 732210100	€ 114,51
Chiave dinamometrica da 3/8", 20-100Nm	
Art. 732310100	€ 116,11
Chiave dinamometrica da 1/2", 20-100Nm	
Art. 732320200	€ 120,22
Chiave dinamometrica da 1/2", 40-200Nm	
Art. 732360300	€ 144,84
Chiave dinamometrica da 1/2", 60-300Nm	
Art. 732380400	€ 170,00
Chiave dinamometrica da 1/2", 80-400Nm	
Art. 7324550	€ 627,42
Chiave dinamometrica da 3/4", 110-550Nm	
Art. 7324750	€ 750,08
Chiave dinamometrica da 3/4", 150-750Nm	
Art. 73241000	€ 958,08
Chiave dinamometrica da 3/4", 1000Nm	
Art. 7325750	€ 761,68
Chiave dinamometrica da 1", 150-750Nm	
Art. 73251000	€ 969,71
Chiave dinamometrica da 1", 200-1000Nm	



INSERIMENTO DIRETTO DEL MECCANISMO A CRICCHETTO DESTRO-SINISTRO

Art. 73021050	€ 115,06
Chiave dinamometrica da 3/8", 10-50Nm,	
Art. 730220100	€ 113,46
Chiave dinamometrica da 3/8", 20-100Nm	
Art. 730320100	€ 113,46
Chiave dinamometrica da 1/2", 20-100Nm	
Art. 730340200	€ 124,08
Chiave dinamometrica da 1/2", 40-200Nm	
Art. 730360300	€ 136,33
Chiave dinamometrica da 1/2", 60-300Nm	
Art. 730380400	€ 170,19
Chiave dinamometrica da 1/2", 80-400Nm	
Art. 7304110550	€ 651,20
Chiave dinamometrica da 3/4", 110-550Nm	
Art. 7304150750	€ 776,40
Chiave dinamometrica da 3/4", 150-750Nm	



€ 27,64



GGO

Art. 300301
Set di bussole per avvitatori ad impulsi 1/2",
3 pezzi
- 17, 19, 21mm
- Max. 200Nm

€ 43,93



Art. 300506
Set di bussole per avvitatori ad impulsi 1/2",
5 pezzi
- 15, 17, 19, 21, 22mm

€ 44,31



Art. 300310
Set di bussole per avvitatori ad impulsi extra
lunghe 1/2", 3 pezzi
- 17, 19, 21mm

€ 33,53



GGO

Art. 300311
Set di chiavi a bussola a macchina rivestite
in plastica per cerchi in lega, 3 pezzi
- 17, 19, 21mm

€ 98,33



GGO

Art. 300304
Set di adattatori 1/2", 3 pezzi
- 3/8", 1/2", 3/4"

€ 95,95



GGO

Art. 300303
Set di bussole a macchina 1/2", 3 pezzi
- 17, 19, 21mm

€ 51,97



GGO

Art. 300302
Set di chiavi a bussola a macchina 1/2", 3 pezzi
- 17, 19, 21mm - parete sottile - plastica arresto
- misura 105mm - max. 200Nm

€ 70,15



€ 24,69



GGO

Art. 805001
Set di chiavi a bussola per candele
snodate, 3 pezzi
- 8, 10, 12mm



GGO

Art. 301601
Set di chiavi a bussola multifunzione 1/2", 16 pezzi
- 8, 9, 10, 11, 12, 13, 14, 15, 16, 17, 18, 19, 20, 21, 22, 24mm

€ 33,28

GGO

Art. 300312
Set di bussole rivestite 1/2" 6pt.
Lungh. 150 mm 3 pezzi
- 17, 19, 21mm

€ 313,38



Art. 402001

Set di chiavi a bussola 12pt. 3/4", 20 pezzi
- 12 Chiavi a bussola : 19-50 mm
- Barra estensibile : 100-200 mm

€ 647,90



Art. 501401

Set di chiavi a bussola 12pt. 1", 15 pezzi
- 12 Ugelli 36, 41, 46, 50, 55, 60, 65, 70, 75, 80mm
- Barra estensibile 200 mm, 400 mm

€ 13,97



GGO

Art. 300603
Set di adattatori, 6 pezzi
- 1/4"(F)x3/8"(M), 3/8"(F)x1/4"(M),
3/8"(F)x1/2"(M), 1/2"(F)x3/8"(M),
1/2"(F)x3/4"(M), 3/4"(F)x1/2"(M)

€ 33,39



GGO

Art. 300605
Set di adattatori a macchina, 6 pezzi
- 1/4"(F)x3/8"(M), 3/8"(F)x1/4"(M),
3/8"(F)x1/2"(M), 1/2"(F)x3/8"(M),
1/2"(F)x3/4"(M), 3/4"(F)x1/2"(M)

€ 5,04



GGO

Art. 100301
Set di adattatori per bussola 1/4" DR, 3 pezzi
- 6.3 + 10 + 12.5mm drivesquare
- 1/4" + 3/8" + 1/2" Attacco
- 6,3 millimetri (1/4") esagonale



€ 15,34



Art. 3310617
Chiave a bussola a macchina 1/2"
- 17mm per Mercedes-Benz 88mm

€ 10,70



Art. 805019
Chiave a bussola per pinza freno 10pt. 1/2" 38mm

€ 40,08



Art. 807001
Set di chiavi a bussola a macchina 12pt. 1/2", 3 pezzi
- 30, 32, 36mm

€ 47,31



Art. 300910
Set di chiavi a bussola a macchina lunghe E 1/2", 9 pezzi
- E10, E11, E12, E14, E16, E18, E20, E22, E24

€ 34,62



Art. 300601
Set di chiavi a bussola a macchina 1/2", 6 pezzi
- M14, M16, M18 - lunghezza 43mm & 78mm

€ 26,88



Art. 801206
Set di chiavi a bussola bolt twister 3/8", 6 pezzi
- 2, 3, 4, 6, 8, 10mm

€ 28,88



Art. 801305
Set di chiavi a bussola bolt twister 1/2", 5 pezzi
- 8, 10, 12, 14, 16mm

€ 60,30



Art. 300504
Set di estrattori per dadi e bulloni danneggiati da 1/2",
5 pezzi
- Rimuove i dadi e i bulloni danneggiati
- 17, 19, 21, 23, 27mm

€ 73,20



Art. 300901
Set di estrattori per dadi e bulloni danneggiati da 3/8",
10 pezzi
- Rimuove i dadi e i bulloni danneggiati
- 10, 11, 12, 13, 14, 15, 16, 17, 19mm

€ 109,31



Art. 818026
Set di estrattori per dadi e bulloni danneggiati, 15 pezzi

€ 35,83



Art. 75214
Set di bussole da 1/4", 36 pezzi

€ 70,15



Art. 104601
Set di chiavi a bussola profilo flank 1/4", 46 pezzi

€ 193,64



Art. 309401
Set di chiavi a bussola con valigia, 94 pezzi



€ 20,29

€ 13,58



Art. 48212380
Leva 380mm
Art. 48212530
Leva 530mm
Art. 48212650
Leva 650mm

€ 8,63

€ 19,67

€ 23,64

Art. 48222500
Leva con cover in plastica 500mm



Art. 47025
Cuscino per ginocchia e seduta
Dimensioni: L 235 x L 475 x A 30mm

€ 50,68

€ 13,98

€ 66,96



Art. 48126
Sgabello girevole per officina
Altezza regolabile 375-495mm



Art. 47242
Telo coprisedili
- Nylon 210d con banda elastica
- Lavaggio a 40°
- Rosso con logo sonic nero



Art. 48105
Letto per riparazioni sottovettura
- Lunghezza 100cm
- Larghezza 48cm
- Altezza 11,5cm

€ 24,43

€ 53,51

€ 17,81



Art. 4821901
Vasca di plastica multiuso, 20l
- Vaschetta in plastica
- Spina di scarico
- Dimensioni: l 685 x d 667 x h65mm

Art. 4821902
Vasca di plastica multiuso, 50l
- Vaschetta in plastica
- Spina di scarico
- Dimensioni: l 800 x b 600 x A 100 mm



Art. 48112
Vaschetta di plastica per la raccolta olio

€ 24,66

€ 22,11

€ 79,03



Art. 48104
Telo di protezione per auto
- Lunghezza: 106,5cm
- Larghezza: 64cm
- Peso: 380gr

Art. 47570
Telo di protezione per auto con tappetino antiscivolo
- Olio, grasso, e acqua

Art. 47571
Telo di protezione frontale universale per auto
- Arriva in una comoda custodia



€ 43,60



Art. 825001
Attrezzo di ricambio cv per tendimorsetto



€ 57,22



Art. 805018
Attrezzo di ricambio cv per tendimorsetto



Art. 487001
Vassoio magnetico 4" 15 cm



Art. 487002
Vassoio magnetico 6x9" / 24x14 cm

€ 29,45

€ 55,20



Guanti rivestiti in nitrile
- Nylon con rivestimento in nitrile. Il rivestimento in nitrile è resistente ai liquidi. Per una migliore adattabilità e un maggiore comfort, solo la parte dell'impugnatura risulta rivestita.
- Traspirante e adattabile ergonomicamente grazie alle punta delle dita parzialmente rivestite.
- Normative europee en388 e 3142.

Art. 4821701 **€ 3,02**
Guanti rivestiti in nitrile, taglia 8 (m)
Art. 4821702 **€ 3,07**
Guanti rivestiti in nitrile, taglia 9 (l)
Art. 4821703 **€ 2,99**
Guanti rivestiti in nitrile, taglia 10 (xl)
*Prezzo cad

€ 6,00



Art. 815002
Magnetic bowl, diameter 150mm



€ 13,33

€ 10,78



Art. 4830703
Estrattore reversibile
2-3 Ganasce da 3"

€ 24,11

Art. 4830704
Estrattore reversibile
2-3 Ganasce da 4"

€ 31,37

Art. 4830706
Estrattore reversibile
2-3 Ganasce da 6"

€ 39,67



€ 27,13

€ 43,74



Art. 47403
Separatore di giunti sferici
(Ganasce da 22 mm)



Art. 47404
Separatore di giunti sferici
(Ganasce da 22 mm)



Art. 47401
Estrattore universale per snodi sferici



Art. 47402
Estrattore universale per snodi sferici

€ 43,34



CGO
Art. 806001
Attrezzi per alternatore, 13 pezzi
- Per la rimozione e l'installazione del dente di puleggia dynamo

€ 57,79



CGO
Art. 818007
Set di chiavi per alternatore, 18 pezzi
- Per la rimozione e l'installazione del dente di puleggia dynamo

€ 37,11

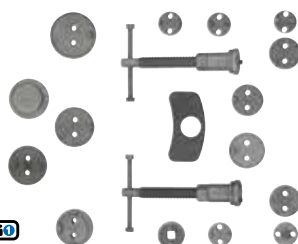

CGO
Art. 801018
Dispositivo di pressione e di rotazione dei pistoncini dei freni, 18 pezzi

€ 122,40

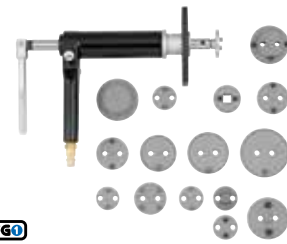

CGO
Art. 801016
Dispositivo pneumatico di pressione e di rotazione dei pistoncini dei freni, 16 pezzi

€ 32,12



CGO
Art. 802214
Set di chiavi a bussola per tappi olio motore 3/8", 14 pezzi

€ 62,77

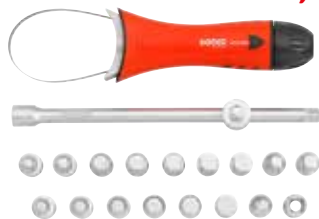

CGO
Art. 302001
Kit scarico olio 1/2", 20 pezzi

€ 133,46



CGO
Art. 805002
Dispositivo di pressione e di rotazione dei pistoncini dei freni, 27 pezzi
- Senso orario e antiorario
- 24 Adattatori e 2 mandrini

€ 144,44

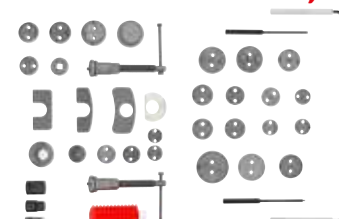

CGO
Art. 809007
Dispositivo di pressione e di rotazione dei pistoncini dei freni, 40 pezzi

€ 71,63



Art. 810006
Set arretratore pistoncini del freno, 5 pezzi

€ 49,71



Art. 829001
Set di adattatori freni - regolabili

€ 13,51



Art. 805010
Mandrino con rotazione sinistra per dispositivo di pressione e di rotazione dei pistoncini dei freni

€ 13,51



Art. 805011
Mandrino con rotazione destra per dispositivo di pressione e di rotazione dei pistoncini dei freni

€ 51,56



CGO
Art. 803003
Set coppa filtro olio, 15 pezzi
- Si adatta 3/8" e 1/2"

€ 114,11

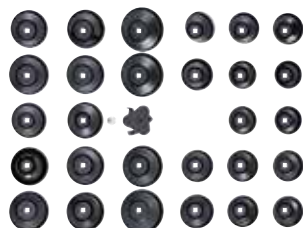

CGO
Art. 811002
Set coppa filtro olio, 30 pezzi
- Si adatta 3/8" e 1/2"

€ 16,90



Art. 4830801
Chiave regolabile universale per filtro olio

€ 19,48



Art. 4830802
Chiave a spirale per filtro olio (65-120mm)

€ 123,84

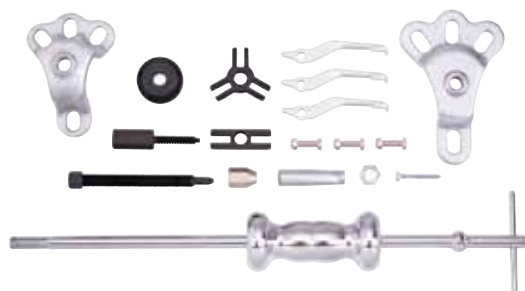

Art. 808001
Set per estrazione mozzi e cuscinetti

€ 6,39



Art. 812006
Chiave universale per pistoncini freni
Uso universale per pistoncini freni con blocco freno e rotazione

€ 43,03



Art. 812008
Catena per filtri olio



€ 36,55

SGO

Art. 47019
Tester di circuito Volt



€ 26,64

SGO

Art. 47035
Multitester digitale ac/dc



€ 90,00

SGO

Art. 47036
Multitester digitale 3 in 1



€ 37,11

SGO

Art. 47031
Termometro digitale a raggi infrarossi
-30° t/m 330°C



€ 38,54

SGO

Art. 820018
Endoscopio WIFI 2 Megapixel con telecamera LED OD 5,5 mm, in set da 8 pezzi
Questo endoscopio è un must per i moderni meccanici di assistenza e diagnostica.

- Questo endoscopio ricaricabile può essere collegato al tuo smartphone o tablet tramite la propria connessione WiFi
- Il diametro della telecamera, dotata di illuminazione a LED regolabile, è di 5,5 mm
- E' possibile creare video e / o immagini dei oggetti ispezionati
- La telecamera è equipaggiata con uno specchio, che consente l'ispezione ad angolo
- La fotocamera può anche essere dotata di un gancio o di un magnete per rimuovere gli oggetti direttamente dalle aree ispezionate
- La lunghezza della sonda flessibile della telecamera è di 3,5 m
- La fotocamera da 2.0 megapixel è protetta secondo IP68

SGO

Art. 47023
Tester digitale liquido freni
- Formato penna
- Per misurare la presenza di acqua nel liquido dei freni
- Con indicatore LED
- Switch off dopo 12 secondi
- Cassa in plastica
- Protezione ip 44
- Lunghezza 150 mm



€ 16,52

SGO

Art. 820019
Siringa multifunzione 500ml



€ 17,41



€ 43,10

SGO

Art. 820007
Kit spazzole pulizia, 38 pezzi



€ 27,13

SGO

Art. 818002
Chiave per sensori ossigeno 22mm
- 6 Per cerniera laterale
- Adatto al montaggio e allo smontaggio dei sensori ossigeno

SGO

Art. 482151
Fascette
Confezioni da 100 pezzi 3,6x140mm

Art. 482152
Fascette
Confezioni da 100 pezzi 3,6x180mm

Art. 482153
Fascette
Confezioni da 100 pezzi 4,8x190mm

Art. 482154
Fascette
Confezioni da 100 pezzi 4,8x220mm

Art. 482155
Fascette
Confezioni da 100 pezzi 4,8x280mm

Art. 482156
Fascette
Confezioni da 100 pezzi 4,8x330mm

Art. 482157
Fascette
Confezioni da 100 pezzi 4,8x370mm

€ 1,81

€ 2,18

€ 3,09

€ 3,87

€ 4,21

€ 5,40

€ 6,03



€ 93,18

SGO

Art. 301302
Set di chiavi a zampa di gallo 1/2", 13 pezzi
- 20, 21, 22, 23, 24, 25, 26, 27, 28, 30, 32mm
- Estensione 125 mm e maniglia 385 mm



€ 830,15



Art. 871192
Pressore molla fino a 1800 chili con staffa aggiuntiva
Set di mascelle da 80-145 mm e set di mascelle da 145-195 mm

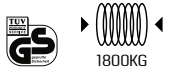

€ 505,12

CE Art. 110001
Pressore per molle ammortizzatori 1800 kg
- Maniglie adattabili al 90% su tutte le automobili
- Fornito con due set di sollevatori: 2-pcs. Ø80-145mm e 2 pcs. Ø145-195mm

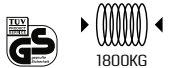

CE Art. 120001
Pressore per molle ammortizzatori 1500 kg
- Maniglie adattabili al 90% su tutte le automobili
- Fornito con due set di sollevatori: 2-pcs. Ø80-145mm e 2 pcs. Ø145-195mm



€ 332,76

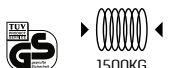

CE Art. 130001
Pressore per molle ammortizzatori 1500 kg
- Maniglie adattabili al 90% su tutte le automobili
- Fornito con due set di sollevatori: 2-pcs. Ø90-120mm e 2 pcs. Ø120-140mm

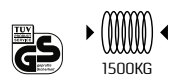

€ 83,79

€ 75,10



Art. 822001
Refrattometro per antigelo e acido della batteria
Questo refrattometro ottico e' stato progettato per il controllo della concentrazione di Addblue. Urea additivo nel flusso di gas di scarico che riduce le emissioni nocive

Art. 822002
Refrattometro
E' stato progettato per il controllo della concentrazione di antigelo e acido delle batterie



€ 34,24



SGO

Art. 810003
Set di attrezzi per rimozione air bag, 12 pezzi

€ 195,42



Art. 600436
Set di leverini heavy duty, 4 pezzi
- Leverino (diritto) 890mm
- Leverino (45°) 890mm
- Leverino (75°) 635mm
- Leverino (90°) 635mm

€ 52,99



Art. 600403
Set di leverini, 4 pezzi
- Leverino piegato da 8°
- Leverino piegato da 12°
- Leverino piegato a gomito da 18°
- Leverino esteso da 24°

€ 20,46



SGO

Art. 803004
Set di leverini, 11 pezzi

€ 11,42



SGO

Art. 803005
Set di leverini, 5 pezzi
Per lavori su fascette decorative, guarnizioni in gomma, cruscotti, elementi di fissaggio porte, interruttori, spine di tenuta

€ 6,32



SGO

Art. 47814
Gancio per anelli di scarico in gomma
Con attrezzo a T ergonomico per un maggiore comfort

€ 7,78

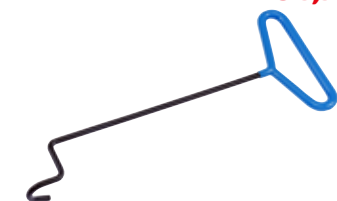

SGO

Art. 47815
Tensionatore ritorto
Per la rimozione dei gommini di fissaggio installati sui sistemi di scarico

€ 17,42



SGO

Art. 600318
Set di cunei, 3 pezzi

€ 6,46



SGO

Art. 47816
Gancio di montaggio
Perfetto per la rimozione e il fissaggio di molle su freni, luci di posizione, silenziatori di moto e per soddisfare molte altre esigenze

€ 75,90



Art. 805003
Set di leverini a crichetto universali, 3 pezzi
Per un utilizzo flessibile, ad esempio, su cuscinetti, pulegge della cinghia, guarnizioni, mozzi di ruote, ecc. Le teste flessibili del leverino possono essere fissate in 8 posizioni e bloccate in sicurezza tramite un meccanismo di pressione installato sull'estremità delle teste. Le estremità della testa conica facilitano un utilizzo ottimale anche con giochi di lavoro minimi. Ogni leverino è disponibile nelle seguenti lunghezze: 250 mm, 300 mm, 380 mm

€ 27,93



SGO

Art. 600506
Set di cunei, 5 pezzi

€ 22,77



Art. 600437
Set di ganci verticali, 4 pezzi

€ 19,59



SGO
Art. 600320
Set di raschietti, 3 pezzi
- Con impugnatura in plastica
- Raschietto curvato, raschietto per guarnizioni, raschietto per adesivi

SGO

Art. 821001
Kit di leverini Master, 27 pezzi

€ 28,41

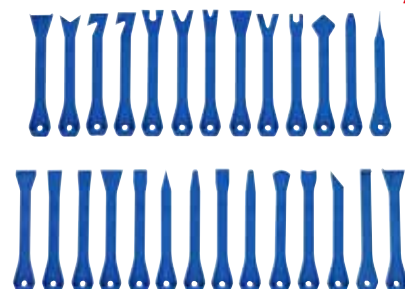



Art. 829003
Estrattore di iniettori diesel con adattatori
Set fondamentale per la rimozione professionale degli iniettori dalle testine dei cilindri



€ 442,99



€ 88,98

Art. 829002
Set per pulizia sedi iniettori, 14 pezzi

€ 15,51



Art. 829005
Attrezzo anticorrosione tubo dei freni

€ 11,78



Art. 829007
Attrezzo di rimozione blocco porta - VW

€ 14,06



Art. 829009
Attrezzo di rimozione giunto di accoppiamento trasmettitore livello/pompa carburante VAG

€ 37,72

€ 105,45



Art. 829004
Dispositivo di invio carburante/attrezzo di rimozione anello di fissaggio delle pompe VAG, 23 pezzi

Art. 829006
Set chiavi a stella per ruote - Audi, 22 pezzi
Set audi completo comprendente adattatore da 21 mm con azionamento quadrato da 1/2" questo kit è progettato per la rimozione dei bulloni di bloccaggio quando il cliente si è dimenticato di lasciare l'adattatore sull'auto. Ciò succede frequentemente quando il veicolo viene portato a riparare e/o lo si sottopone a manutenzione. Adatto per oem T40073.

€ 123,84

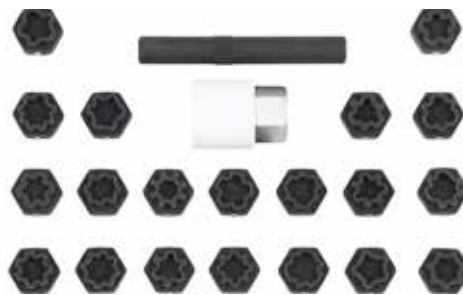

**WORK
EFFICIENT
WORK
WITH SONIC**



€ 326,38

€ 114,11

€ 155,98

€ 507,20



Art. 818008
Set di attrezzi di allineamento frizione, 38 pezzi



Art. 816001
Set di estrattori per cuscinetti



Art. 818014
Set prova pressione del radiatore, 14 pezzi

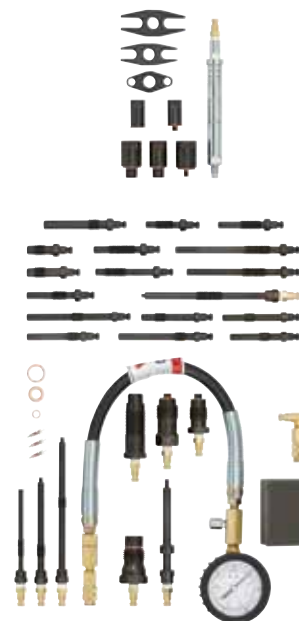

Art. 818010
Set prova compressione Master, 37 pezzi

€ 125,36

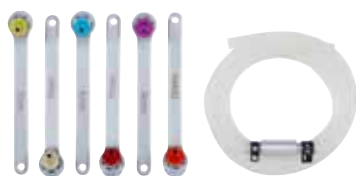

Art. 829113
Set di cavi di sfilato del freno 6pt., 6 pezzi

€ 457,24

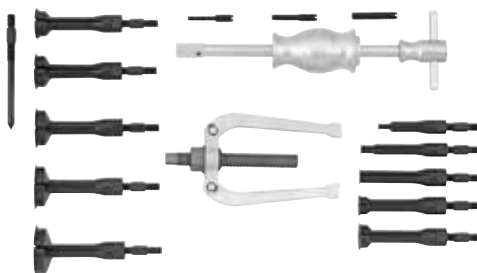

Art. 818021
Set estrattori per cuscinetti con foro cieco, 16 pezzi

€ 125,29



Art. 812001
Kit per rimozione tergicristalli

€ 156,40



Art. 828001
Kit di attrezzi per riparazione pneumatici, 45 pezzi

€ 58,18



Art. 805012
Set di attrezzi di iniettori/estrazione iniettori Per uno smontaggio e un'installazione professionali di iniettori/valvole di iniezione e unità pompa-ugello

€ 220,07

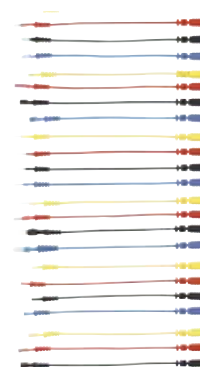

Art. 818023
Tester per circuiti elettronici, 92 pezzi

€ 23,79

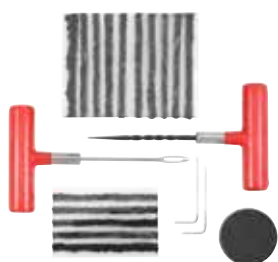

Art. 828001
Kit di attrezzi per riparazione pneumatici, 45 pezzi

€ 60,19



Art. 818001
Set dispositivi di allineamento frizione, 15-28 mm, 15 pezzi

€ 112,76



Art. 805012
Set di attrezzi di iniettori/estrazione iniettori Per uno smontaggio e un'installazione professionali di iniettori/valvole di iniezione e unità pompa-ugello

€ 35,92

€ 132,10

€ 65,84

€ 121,70



Art. 818015
Set di prova compressione per motori a benzina, 8 pezzi

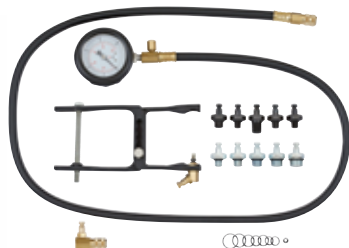

Art. 818011
Set di prova pressione dell'olio, 14 pezzi



Art. 818025
Set prova pressione dell'olio, 22 pezzi



Art. 826001
Set pompa per la misurazione della pressione dei freni



€ 119,22

Art. 805015
Set chiavi a stella, 12pt.-19mm, E10-E18, 15 pezzi
Testa intercambiabile per la chiave per pulegge. Set di 8 chiavi (bi-esagonali) poligonali e prolunga per l'allentamento dei bulloni usati per la messa in fase, il tenditore e la puleggia ausiliaria. Ideale per la maggior parte delle auto.



€ 97,58

Art. 812002
Set di chiavi per pulegge, 5 pezzi
- Ideale per le pulegge
- Misure 13-15-17-19 mm
- Manico soft grip
- Disegno ricurvo per raggiungere qualsiasi accesso

€ 191,52

€ 49,88

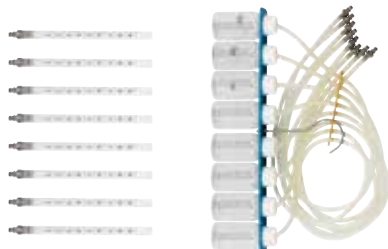

Art. 818009
Set di misuratori di flusso a binario comune per 8 cilindri

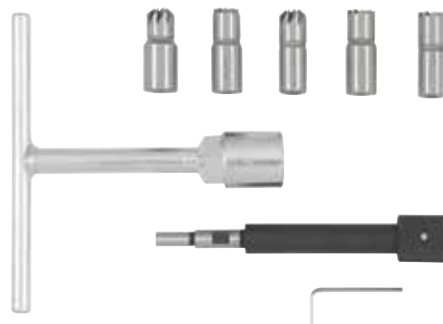

Art. 818004
Set per pulizia sedi iniettori, 7 pezzi

€ 42,70

€ 96,91



Art. 818012
Set prove di tenuta, 10 pezzi

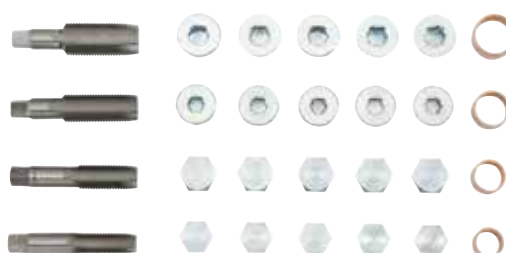

Art. 801003
Kit per riparazione scarico olio



SGO

Art. 815001
Portautensili magnetico

€ 45,84



SGO

Art. 46701
Forbici

€ 17,01



SGO

Art. 46806
Cutter con lama trapezoidale
(10 lame di ricambio incluse)

€ 10,14



€ 11,52

SGO

Art. 46804
Cutter universale
Vendibile in display da 8 pezzi



€ 17,89

SGO

Art. 46807
Cutter a lama trapezoidale retrattile
(3 lame incluse)



€ 12,30

SGO

Art. 818028
Forcella per rimozione e montaggio 16"
- Per asta e teste



€ 36,20

Art. 46601
Seghetto super heavy duty



STOP GO
FUNCTION

Art. 47013
Flessometro 5 metri

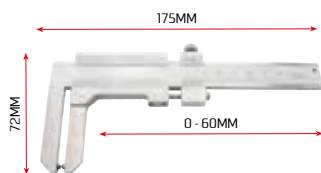

Art. 47024
Calibro a corsoio per disco freni in acciaio inox



SGO

Art. 810004
Driver per valvola pneumatico, 2 pezzi



SGO

Art. 812003
Attrezzo di montaggio del gambo valvola
pneumatico 310L

€ 18,99



Art. 46905
Lima triangolare per freni 8"
- Per rimuovere la sporcizia dai dischi freni

€ 16,45



Art. 600624
Set di 6 bulini
- 115mm 2, - 125mm 3, - 150mm 4,
- 165mm 5, - 180mm 6, - 180mm 8

€ 5,35



SGO

Art. 4811260
Spazzola per pulizia pinza freno
- Da usare solo su freni in alluminio.
idoneo anche per la pulizia di tutte le
parti metalliche

€ 5,24



€ 16,64



Art. 4820207
Penna flessibile magnetica 500gr-400mm

€ 5,75



Art. 4820106
Penna telescopica magnetica 2,8kg
- Vendibile in display di 16 pezzi

€ 77,33



SGO

Art. 818003
Calibro cinghia



Art. 4811254
Spazzola per pulizia pinza freno in acciaio
- Vendibile in display di 12 pezzi



Art. 4822310
Assortimento di anelli di tenuta, 150 pezzi

€ 21,23

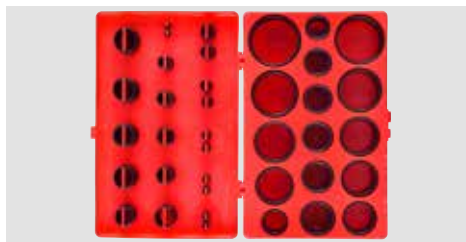

Art. 4822323
Assortimento di O-ring, 419 pezzi

€ 15,96



Art. 4822322
Assortimento di O-ring, 225 pezzi

€ 6,51



Art. 4822308
Assortimento di spine, 555 pezzi

€ 9,42



Art. 4822315
Assortimento di bulloni e dadi corpo di velocità, 170 pezzi

€ 8,59



Art. 4822301
Assortimento di elastici tipo E, 300 pezzi

€ 9,20



Art. 4822313
Assortimento di fascette stringitubo, 26 pezzi

€ 6,40



Art. 4822321
Assortimento di guaine di gomme, 180 pezzi

€ 7,51



Art. 4822316
Assortimento di morsetti a coccodrillo, 28 pezzi

€ 6,56



Art. 4822330
Assortimento rondelle in alluminio, 300 pezzi

€ 22,27



Art. 4822335
Assortimento di fusibili lamellari per autoveicoli, 80 pezzi

€ 5,50



Art. 4822312
Assortimenti di perni cavi di anelli sincronizzatori, 450 pezzi

€ 20,53



Art. 4822325
Mini auto fuse assortment, 120-pcs

€ 9,20

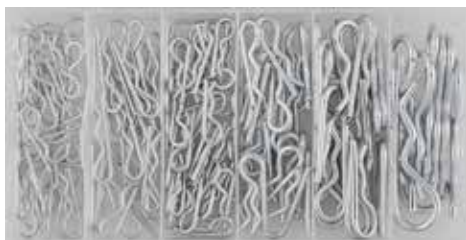

Art. 4822303
W-clip assortment, 150-pcs

€ 7,76



Art. 4822319
Blind rivet assortment, 400-pcs

€ 8,91



Art. 4822318
Assortimento di dadi, 146 pezzi

€ 8,42



Art. 4822317
Assortimento di fusibili lamellari per autoveicoli, 121 pezzi

€ 7,84



Art. 4822314
Assortimento di dadi, 146 pezzi

€ 12,20

€ 31,05



Art. 4822342
Assortimento di clip per Nissan, 408 pezzi

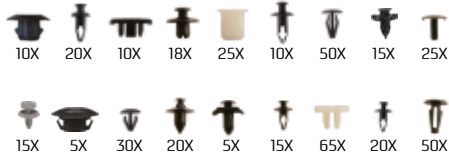

€ 30,93

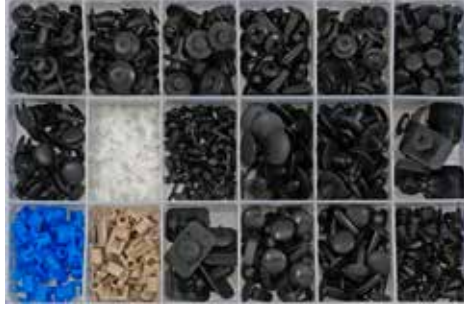

Art. 4822343
Assortimento di clip per Mazda, 475 pezzi



€ 28,03



Art. 4822344
Assortimento di clip per Mitsubishi, 370 pezzi



€ 31,51

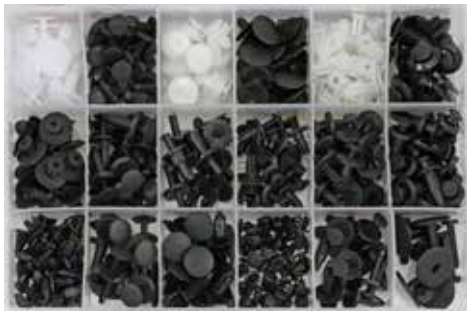

Art. 4822345
Assortimento di clip per Ford, 415 pezzi



€ 29,68



Art. 4822346
Assortimento di clip per Volkswagen, 255 pezzi



€ 28,15



Art. 4822347
Assortimento di autoagganci in plastica, 350 pezzi



**WORK
EFFICIENT
WORK
WITH SONIC**



€ 38,79



Art. 4822348
Assortimento di clip per Toyota/Lexus, 360 pezzi

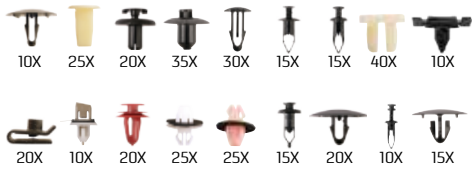

€ 30,60



Art. 4822351
Assortimento di clip per Peugeot, 345 pezzi



€ 37,81



Art. 4822354
Assortimento di clip per BMW, 290 pezzi



€ 37,15



Art. 4822349
Assortimento di clip per Renault, 300 pezzi



€ 28,86



Art. 4822352
Assortimento di clip per Fiat, 308 pezzi

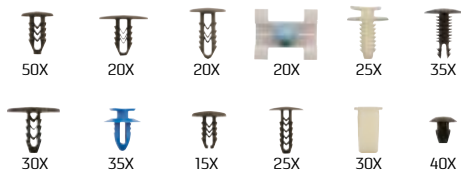

€ 44,40



Art. 4822355
Assortimento di clip per Mercedes Benz, 270 pezzi

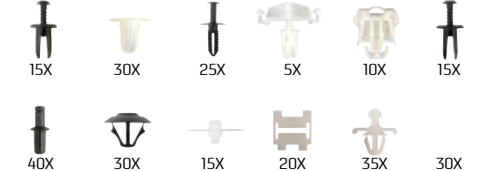

€ 28,56



Art. 4822350
Assortimento di clip per Vauxhall/ Opel, 300 pezzi



€ 31,05



Art. 4822353
Assortimento di clip per Volvo, 350 pezzi

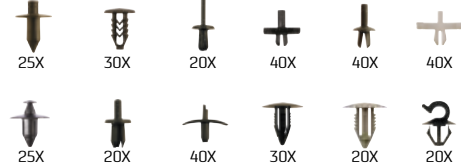

€ 38,64



Art. 4822356
Assortimento di clip per Audi, 160 pezzi



Art. 605003

VDE set di 50 pezzi

Un set completo da 50 utensili isolati 1000 V, certificato VDE e GS.

€ 678,51

Il set include:

- Cacciaviti: PH.1 x 80mm, PH.2 x 100mm, PH.2 x 150mm A taglio: 2.5 x 75 mm, 3 x 100 mm, 3.5 x 100 mm TX: T20 x 100 mm, T25 x 125 mm, T30 x 150 mm
- Set bussole 3/8": 6, 7, 8, 9, 10, 11, 12, 13, 14, 15, 16, 17, 18, 19, 20, 22mm
- Prolunghe 3/8": 150, 250 mm
- Cricchetto 3/8"
- 3 Chiavi maschio: M8, M10, M12
- Set di pinze: cesoie per cavi, pinze a becchi piegati, pinze a becchi lunghi, pinze a becchi piatti, tronchesi laterali, pinze per pompa dell'acqua e un coltello spelacavi isolato.
- Più 10 guaine protettive da 100 mm: 5 x 18 mm e 5 x 24 mm

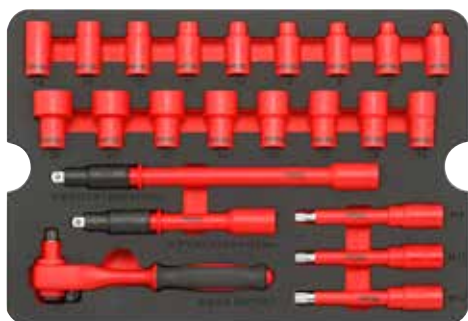

€ 36,72



Art. 1610
Giravite VDE, PH.0

€ 7,60

Art. 1611
Giravite VDE, PH.1

€ 9,80

Art. 1612
Giravite VDE, PH.2

€ 11,50



Art. 16325
Giravite VDE, intaglio 2.5mm

€ 7,17

Art. 16304
Giravite VDE, intaglio 4mm

€ 9,59

Art. 16355
Giravite VDE, intaglio 5.5mm

€ 10,15

Art. 16365
Giravite VDE, intaglio 6.5mm

€ 12,28



Art. 4322200
Pinza a becchi mezzotondi lunghi dritti VDE

€ 36,32

Art. 4312180
Pinza universale VDE

€ 28,50

Art. 4342160
Tronchesi a tagliente diagonale VDE

€ 30,25

Art. 4472160
Pinza spellafilo VDE (Germania)

€ 43,78

Art. 601020

Set di cacciaviti VDE isolati a doppia impugnatura, 10 pezzi

Questi giraviti isolati ad innesto rapido possono essere utilizzati come un giravite di precisione o normale. Grazie al sistema di bloccaggio, i cacciaviti a innesto possono essere cambiati rapidamente.

Tutte le parti sono approvate per l'uso fino a 1000V.

Questo set contiene 2x PH, 2x PZ e 4x cacciaviti a taglio.



Art. 832001

Pistola termica 1800W

Pistola termica di alta qualità con controllo esteso della temperatura e del flusso d'aria con 3 regolazioni. Motore da 1800 W incredibilmente potente, che può raggiungere rapidamente una temperatura di 550°C. La pistola termica ha una sicurezza termica migliorata: la pistola si spegnerà automaticamente quando il motore si surriscalda

Cosumo energetico nominale 1800Watt

- Alimentazione: 220-240V / 50-60Hz
- Lunghezza cavo: 2m

Temperatura di lavoro e flusso d'aria regolabili in continuo in 3 posizioni:

- Posizione 1: 50 °C / 250 l/min
- Posizione 2: 450 °C / 250 l/min
- Posizione 3: 550 °C / 500 l/min - 4 bocchagli inclusi



Art. 832002

Pistola termica 2000W, con display digitale

Pistola termica di alta qualità con controllo esteso della temperatura e del flusso d'aria. Display digitale con funzione di memoria e regolazione infinitesimale della temperatura. Motore da 2000 W incredibilmente robusto, che può raggiungere rapidamente una temperatura di 650°C. La pistola termica ha un avanzato sistema di protezione termica, spegnendosi automaticamente quando il motore si surriscalda.

- Consumo energetico nominale: 2000Watt

- Alimentazione: 220-240 V / 50-60 Hz
- Lunghezza cavo: 2m

Temperatura di lavoro e flusso d'aria regolabile in 2 posizioni: 50 - 650°C

- Posizione 1: 50°C / flusso d'aria 250-500 l / min
- Posizione 2: 50-650°C / flusso d'aria 250-500 l / min
- 4 bocchagli inclusi
- Riposto in custodia rigida



GIRAVITE, INTAGLIO DIN. ISO 2380-1 + 2380-2

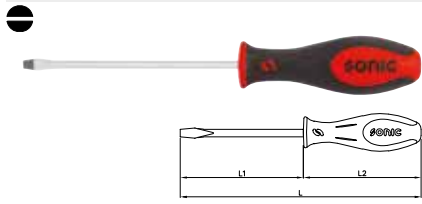

ART.	DIMENSION	L(MM)	G	PREZZO
13303	3	167	20	€ 4,97
13335	3.5	192	24	€ 5,18
13304	4	192	28	€ 5,33
13355	5.5	228	72	€ 7,31
13365	6.5	265	104	€ 8,80
13308	8	299	164	€ 11,79
13310	10	324	228	€ 14,20
13312	12	324	238	€ 14,91

GIRAVITE, PH DIN. ISO 8764-1 + 8764-2

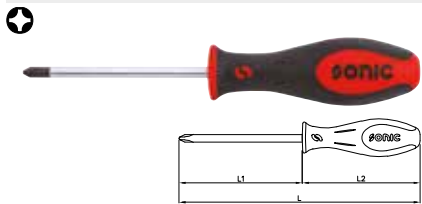

ART.	DIMENSION	L(MM)	G	PREZZO
1310	PH.0	152	20	€ 4,97
1311	PH.1	183	62	€ 7,17
1312	PH.2	215	94	€ 8,09
1313	PH.3	274	156	€ 11,15

GIRAVITE, TX

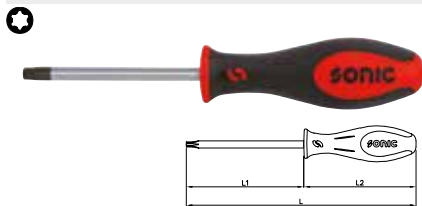

ART.	DIMENSION	L(MM)	G	PREZZO
13605	T5	167	24	€ 5,54
13606	T6	167	24	€ 5,54
13607	T7	167	24	€ 5,54
13608	T8	167	24	€ 5,54
13609	T9	167	26	€ 5,54
13610	T10	203	64	€ 7,46
13615	T15	203	66	€ 7,46
13620	T20	203	68	€ 7,46
13625	T25	215	94	€ 8,38
13627	T27	215	94	€ 8,38
13630	T30	215	94	€ 8,38
13640	T40	215	102	€ 8,80
13645	T45	224	136	€ 11,15

CHIAVE A BUSSOLA PROFILO FLANK 1/4", 6 PT. DIN. 3120/3124

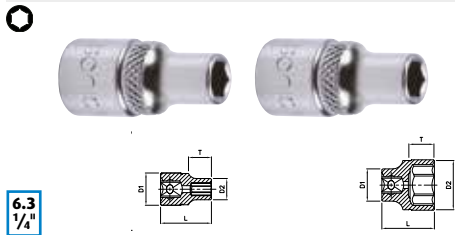

6.3
1/4"

ART.	DIMENSION	L(MM)	G	PREZZO
21503	3	25,0	10	€ 2,96
21504	4	25,0	10	€ 2,75
21545	4.5	25,0	10	€ 2,75
21505	5	25,0	10	€ 2,75
21555	5.5	25,0	10	€ 2,75
21506	6	25,0	10	€ 2,75
21507	7	25,0	12	€ 2,75
21508	8	25,0	10	€ 2,75
21509	9	25,0	12	€ 2,75
21510	10	25,0	12	€ 2,70
21511	11	25,0	16	€ 2,90
21512	12	25,0	18	€ 3,08
21513	13	25,0	18	€ 3,18
21514	14	25,0	26	€ 3,52

CHIAVE A BUSSOLA PROFILO FLANK 1/4" LUNGA, 6 PT. DIN. 3120/3124

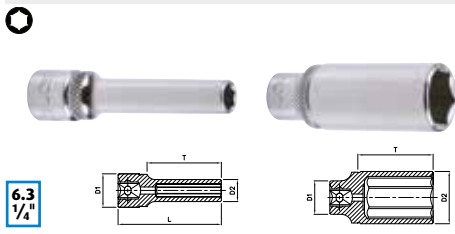

6.3
1/4"

ART.	DIMENSION	L(MM)	G	PREZZO
2155004	4	50,0	16	€ 4,94
21550045	4.5	50,0	16	€ 4,94
2155005	5	50,0	16	€ 4,72
21550055	5.5	50,0	14	€ 4,72
2155006	6	50,0	18	€ 4,72
2155007	7	50,0	22	€ 4,62
2155008	8	50,0	22	€ 4,62
2155009	9	50,0	28	€ 4,72
2155010	10	50,0	32	€ 4,72
2155011	11	50,0	38	€ 4,84
2155012	12	50,0	42	€ 5,05
2155013	13	50,0	46	€ 5,16
2155014	14	50,0	52	€ 4,84

CHIAVE A BUSSOLA 1/4", 12 PT. DIN. 3120

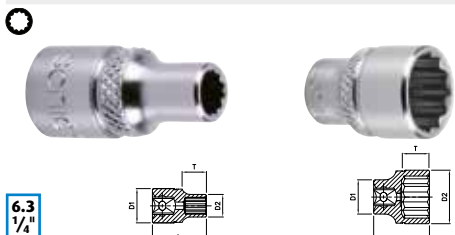

6.3
1/4"

ART.	DIMENSION	L(MM)	G	PREZZO
21804	4	25	10	€ 2,64
21845	4.5	25	10	€ 2,64
21805	5	25	10	€ 2,64
21855	5.5	25	10	€ 2,64
21806	6	25	10	€ 2,64
21807	7	25	12	€ 2,64
21808	8	25	10	€ 2,75
21809	9	25	12	€ 2,75
21810	10	25	12	€ 2,75
21811	11	25	16	€ 2,96
21812	12	25	18	€ 3,08
21813	13	25	18	€ 3,18

CHIAVE A BUSSOLA 1/4" LUNGA, 12 PT. DIN. 3120

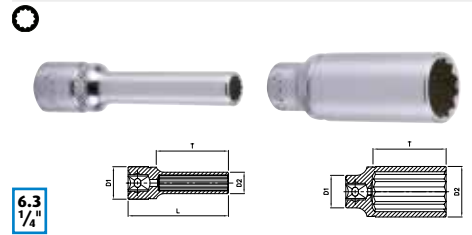

6.3
1/4"

ART.	DIMENSION	L(MM)	G	PREZZO
2185004	4	50	16	€ 4,72
21850045	4.5	50	16	€ 4,72
2185005	5	50	16	€ 4,62
21850055	5.5	50	14	€ 4,62
2185006	6	50	18	€ 4,62
2185007	7	50	22	€ 4,50
2185008	8	50	22	€ 4,62
2185009	9	50	28	€ 4,50
2185010	10	50	32	€ 4,72
2185011	11	50	38	€ 4,72
2185012	12	50	42	€ 4,84
2185013	13	50	46	€ 5,16

CHIAVE A BUSSOLA PROFILO FLANK 3/8", 6 PT. DIN. 3120/3124

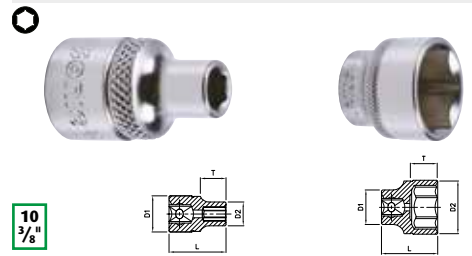

10
3/8"

ART.	DIMENSION	L(MM)	G	PREZZO
22506	6	28,0	20	€ 3,30
22507	7	28,0	22	€ 3,30
22508	8	28,0	22	€ 3,08
22509	9	28,0	22	€ 3,08
22510	10	28,0	22	€ 3,18
22511	11	28,0	24	€ 3,18
22512	12	28,0	22	€ 3,18
22513	13	28,0	24	€ 3,30
22514	14	28,0	28	€ 3,41
22515	15	28,0	34	€ 3,73
22516	16	28,0	32	€ 3,73
22517	17	30,0	40	€ 4,07
22518	18	30,0	42	€ 4,28
22519	19	30,0	46	€ 4,28
22520	20	30,0	60	€ 4,84
22521	21	30,0	50	€ 4,72
22522	22	32,0	60	€ 5,27
22524	24	32,0	62	€ 5,71

CHIAVE A BUSSOLA PROFILO FLANK 3/8" LUNGA, 6 PT. DIN. 3120/3124

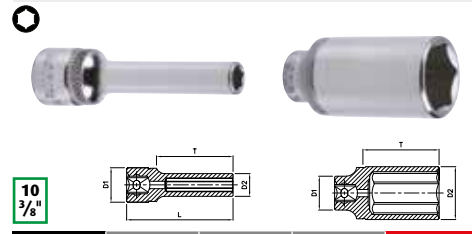

10
3/8"

ART.	DIMENSION	L(MM)	G	PREZZO
2256306	6	63,0	34	€ 6,48
2256307	7	63,0	36	€ 6,48
2256308	8	63,0	34	€ 6,36
2256309	9	63,0	44	€ 6,36
2256310	10	63,0	46	€ 6,26
2256311	11	63,0	50	€ 6,26
2256312	12	63,0	62	€ 5,71
2256313	13	63,0	68	€ 5,71
2256314	14	63,0	74	€ 6,04
2256315	15	63,0	96	€ 6,36
2256316	16	63,0	82	€ 6,48
2256317	17	63,0	106	€ 6,92
2256318	18	63,0	130	€ 7,47
2256319	19	63,0	116	€ 7,47
2256320	20	63,0	148	€ 8,24
2256321	21	63,0	126	€ 8,24
2256322	22	63,0	160	€ 9,01

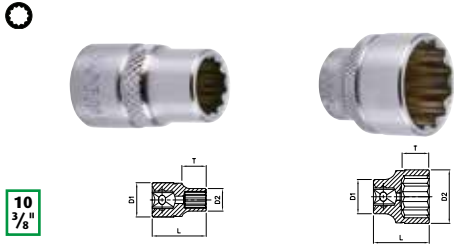
CHIAVE A BUSSOLA 3/8", 12 PT. DIN. 3120

10
3/8"

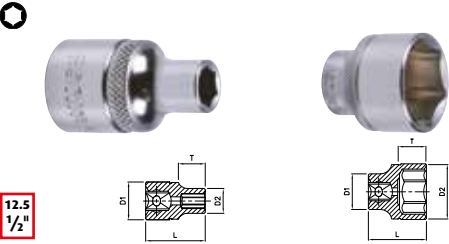
ART.	DIMENSION	L(MM)	G	PREZZO
22806	6	28	20	€ 3,30
22807	7	28	22	€ 3,30
22808	8	28	22	€ 3,08
22809	9	28	22	€ 3,08
22810	10	28	22	€ 3,18
22811	11	28	24	€ 3,18
22812	12	28	22	€ 3,18
22813	13	28	24	€ 3,30
22814	14	28	28	€ 3,41
22815	15	28	34	€ 3,73
22816	16	28	32	€ 3,73
22817	17	30	40	€ 4,07
22818	18	30	42	€ 4,28
22819	19	30	46	€ 4,28
22820	20	30	60	€ 4,84
22821	21	30	50	€ 4,72
22822	22	32	60	€ 5,27
22824	24	32	62	€ 5,71

CHIAVE A BUSSOLA PROFILO FLANK 1/2", 6 PT. DIN. 3120/3124

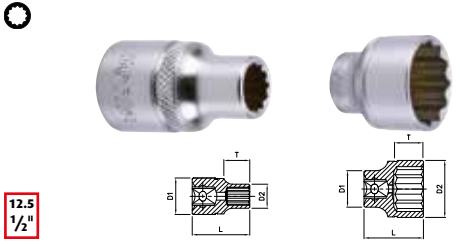
12.5
1/2"

ART.	DIMENSION	L(MM)	G	PREZZO
23508	8	38,0	46	€ 4,28
23509	9	38,0	48	€ 4,28
23510	10	38,0	48	€ 4,28
23511	11	38,0	50	€ 4,28
23512	12	38,0	50	€ 4,28
23513	13	38,0	52	€ 4,28
23514	14	38,0	54	€ 4,28
23515	15	38,0	52	€ 4,28
23516	16	38,0	48	€ 4,28
23517	17	38,0	60	€ 4,66
23518	18	38,0	70	€ 5,04
23519	19	38,0	58	€ 5,04
23520	20	38,0	70	€ 5,32
23521	21	38,0	60	€ 5,80
23522	22	38,0	88	€ 6,27
23523	23	38,0	98	€ 6,56
23524	24	38,0	90	€ 6,84
23525	25	42,0	118	€ 7,70
23526	26	42,0	142	€ 7,70
23527	27	42,0	136	€ 9,12
23528	28	43,0	154	€ 10,07
23529	29	43,0	134	€ 10,07
23530	30	43,0	158	€ 11,21
23532	32	43,0	168	€ 12,16
23536	36	43,0	226	€ 19,21

CHIAVE A BUSSOLA 1/2", 12 PT. DIN. 3120

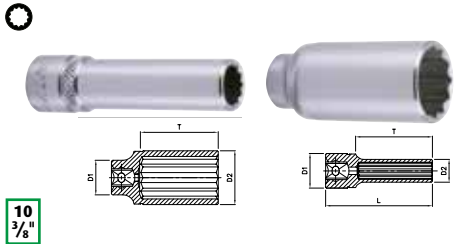
12.5
1/2"

ART.	DIMENSION	L(MM)	G	PREZZO
23808	8	38	46	€ 4,28
23809	9	38	48	€ 4,28
23810	10	38	48	€ 4,28
23811	11	38	50	€ 4,28
23812	12	38	50	€ 4,28
23813	13	38	52	€ 4,28
23814	14	38	54	€ 4,28
23815	15	38	52	€ 4,28
23816	16	38	48	€ 4,28
23817	17	38	60	€ 4,72
23818	18	38	70	€ 4,66
23819	19	38	58	€ 4,66
23820	20	38	70	€ 5,32
23821	21	38	60	€ 5,42
23822	22	38	88	€ 5,89
23823	23	38	98	€ 6,56
23824	24	38	90	€ 6,84
23825	25	42	118	€ 7,70
23826	26	42	142	€ 7,70
23827	27	42	136	€ 8,84
23828	28	43	154	€ 10,07
23829	29	43	134	€ 10,07
23830	30	43	158	€ 11,50
23832	32	43	168	€ 11,69

CHIAVE A BUSSOLA 3/8" LUNGA, 12 PT. DIN. 3120

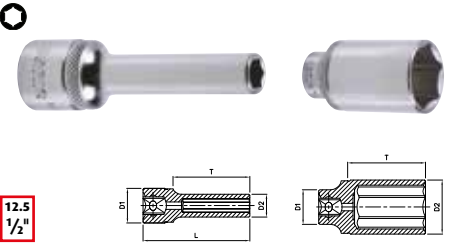
10
3/8"

ART.	DIMENSION	L(MM)	G	PREZZO
2286306	6	63	34	€ 6,48
2286307	7	63	36	€ 6,48
2286308	8	63	34	€ 6,36
2286309	9	63	44	€ 6,36
2286310	10	63	46	€ 6,26
2286311	11	63	50	€ 6,26
2286312	12	63	62	€ 5,71
2286313	13	63	68	€ 5,71
2286314	14	63	74	€ 6,04
2286315	15	63	96	€ 6,36
2286316	16	63	82	€ 6,48
2286317	17	63	106	€ 6,92
2286318	18	63	130	€ 7,47
2286319	19	63	116	€ 7,47
2286320	20	63	148	€ 8,24
2286321	21	63	126	€ 8,24
2286322	22	63	160	€ 9,01
2286324	24	63	210	€ 8,67

CHIAVE A BUSSOLA PROFILO FLANK 1/2" LUNGA, 6 PT. DIN. 3120/3124

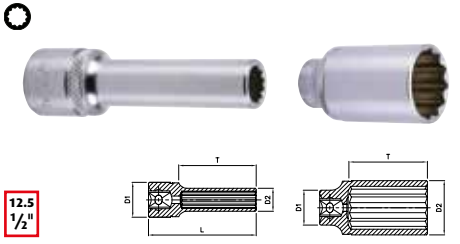
12.5
1/2"

ART.	DIMENSION	L(MM)	G	PREZZO
2357708	8	77,0	70	€ 8,36
2357709	9	77,0	74	€ 8,36
2357710	10	77,0	66	€ 8,17
2357711	11	77,0	78	€ 8,02
2357712	12	77,0	82	€ 8,02
2357713	13	77,0	96	€ 8,08
2357714	14	77,0	104	€ 7,79
2357715	15	77,0	98	€ 7,79
2357716	16	77,0	100	€ 7,70
2357717	17	77,0	130	€ 8,36
2357718	18	77,0	154	€ 8,36
2357719	19	77,0	142	€ 8,36
2357720	20	77,0	168	€ 9,98
2357721	21	77,0	152	€ 10,07
2357722	22	77,0	204	€ 11,31
2357723	23	77,0	228	€ 11,69
2357724	24	77,0	218	€ 12,16
2357725	25	77,0	254	€ 13,30
2357726	26	77,0	300	€ 14,92
2357727	27	77,0	286	€ 15,49
2357728	28	77,0	320	€ 17,67
2357729	29	77,0	300	€ 17,67
2357730	30	77,0	346	€ 18,72
2357732	32	77,0	364	€ 20,62

CHIAVE A BUSSOLA 1/2" LUNGA, 12 PT. DIN. 3120

12.5
1/2"

ART.	DIMENSION	L(MM)	G	PREZZO
2387708	8	77	70	€ 8,36
2387709	9	77	74	€ 8,36
2387710	10	77	66	€ 8,02
2387711	11	77	78	€ 8,02
2387712	12	77	82	€ 8,02
2387713	13	77	96	€ 7,60
2387714	14	77	104	€ 7,90
2387715	15	77	98	€ 7,90
2387716	16	77	100	€ 7,90
2387717	17	77	130	€ 7,98
2387718	18	77	154	€ 7,98
2387719	19	77	142	€ 7,98
2387720	20	77	168	€ 9,98
2387721	21	77	152	€ 9,88
2387722	22	77	204	€ 11,21
2387723	23	77	228	€ 12,16
2387724	24	77	218	€ 12,07
2387725	25	77	254	€ 13,68
2387726	26	77	300	€ 15,30
2387727	27	77	286	€ 15,87
2387728	28	77	320	€ 18,24
2387729	29	77	300	€ 18,24
2387730	30	77	346	€ 19,38
2387732	32	77	364	€ 21,19

CHIAVE A BUSSOLA 3/4", 12 PT.

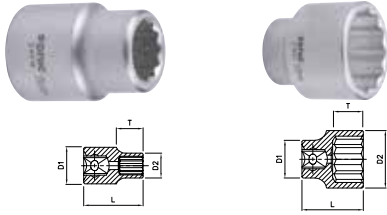
DIN. 3120



20 3/4"

ART.	DIMENSION	L(MM)	G	PREZZO
24917	17	50	140	€ 14,55
24918	18	50	150	€ 14,55
24919	19	50	164	€ 13,71
24920	20	50	170	€ 14,55
24921	21	50	166	€ 13,71
24922	22	50	208	€ 13,71
24923	23	50	208	€ 13,86
24924	24	51	214	€ 13,86
24925	25	52	220	€ 15,55
24926	26	52	214	€ 16,32
24927	27	52	214	€ 15,71
24928	28	52	240	€ 16,25
24929	29	52	232	€ 17,02
24930	30	54	274	€ 17,40
24932	32	56	286	€ 18,25
24933	33	56	320	€ 20,41
24934	34	56	340	€ 20,41
24935	35	58	376	€ 21,33
24936	36	58	400	€ 22,02
24938	38	60	464	€ 23,02
24941	41	64	526	€ 26,33
24942	42	64	560	€ 28,57
24946	46	66	632	€ 31,49
24950	50	70	760	€ 35,34
24955	55	76	900	€ 46,20
24960	60	78	1050	€ 53,28

CHIAVE A BUSSOLA A MACCHINA 1/2", 6PT.

DIN. 3121/3129

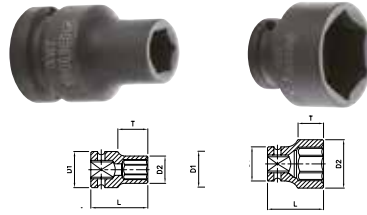

12.5 1/2"

ART.	DIMENSION	L(MM)	G	PREZZO
33508	8	38	60	€ 5,32
33509	9	38	60	€ 5,32
33510	10	38	60	€ 5,32
33511	11	38	62	€ 5,32
33512	12	38	64	€ 5,32
33513	13	38	68	€ 5,32
33514	14	38	80	€ 5,32
33515	15	38	76	€ 5,32
33516	16	38	72	€ 5,42
33517	17	38	90	€ 5,99
33518	18	38	108	€ 6,84
33519	19	38	102	€ 6,84
33520	20	38	120	€ 7,60
33521	21	38	114	€ 7,98
33522	22	38	132	€ 8,93
33523	23	38	118	€ 9,98
33524	24	38	126	€ 9,98
33525	25	38	142	€ 10,93
33526	26	38	134	€ 10,93
33527	27	39	156	€ 11,78
33528	28	40	164	€ 13,11
33529	29	40	162	€ 13,11
33530	30	40	184	€ 14,63
33532	32	40	188	€ 15,11
33533	33	44	310	€ 17,29
33534	34	44	320	€ 19,10
33535	35	48	330	€ 20,43
33536	36	48	330	€ 21,00
33538	38	48	480	€ 25,18

CHIAVE A BUSSOLA A MACCHINA 3/4", 6PT.

DIN. 3121/3129

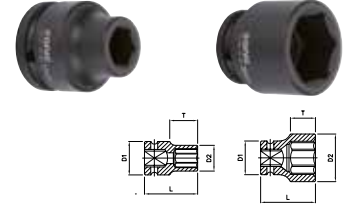

20 3/4"

ART.	DIMENSION	L(MM)	G	PREZZO
34517	17	51	328	€ 24,64
34518	18	51	320	€ 24,64
34519	19	51	325	€ 24,26
34520	20	51	330	€ 24,26
34521	21	51	340	€ 23,95
34522	22	51	345	€ 23,25
34523	23	51	350	€ 23,25
34524	24	51	350	€ 22,87
34525	25	54	360	€ 22,87
34526	26	54	360	€ 23,25
34527	27	54	370	€ 23,25
34528	28	54	386	€ 23,95
34529	29	54	410	€ 23,95
34530	30	54	410	€ 23,95
34532	32	57	450	€ 25,26
34533	33	57	480	€ 26,64
34534	34	57	490	€ 29,03
34535	35	57	490	€ 29,11
34536	36	57	536	€ 29,34
34538	38	57	540	€ 31,72
34539	39	57	540	€ 31,88
34540	40	57	560	€ 32,57
34541	41	58	610	€ 33,73
34542	42	58	630	€ 35,11
34543	43	63	670	€ 36,73
34544	44	63	670	€ 39,27
34545	45	63	710	€ 40,96
34546	46	63	710	€ 40,96
34547	47	68	800	€ 42,27
34548	48	68	800	€ 45,12
34550	50	68	850	€ 50,90
34552	52	68	900	€ 53,52
34554	54	73	950	€ 54,52
34555	55	73	1100	€ 56,06
34557	57	73	1200	€ 62,52
34558	58	73	1300	€ 68,68
34559	59	73	1400	€ 72,23
34560	60	75	1400	€ 72,53
34563	63	75	1600	€ 75,15
34565	65	78	1700	€ 82,54
34570	70	84	1900	€ 124,89

CHIAVE A BUSSOLA 1", 12 PT.

DIN. 3120

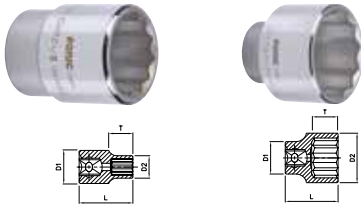

25 1"

ART.	DIMENSION	L(MM)	G	PREZZO
25835	35	61	430	€ 33,76
25836	36	65	454	€ 33,76
25838	38	65	485	€ 37,68
25841	41	70	580	€ 38,80
25846	46	75	806	€ 44,72
25850	50	75	956	€ 53,44
25854	54	80	1150	€ 69,44
25855	55	80	1190	€ 70,80
25858	58	80	1285	€ 78,16
25860	60	84	1248	€ 78,56
25863	63	87	1500	€ 95,92
25865	65	87	1450	€ 103,52
25867	67	90	1640	€ 112,16
25870	70	93	1946	€ 117,12
25871	71	93	2100	€ 135,44
25875	75	97	2294	€ 135,44
25877	77	103	2500	€ 146,64
25880	80	103	2328	€ 146,64

CHIAVE A BUSSOLA A MACCHINA 1/2" LUNGA, 6PT.

DIN. 3121/3129

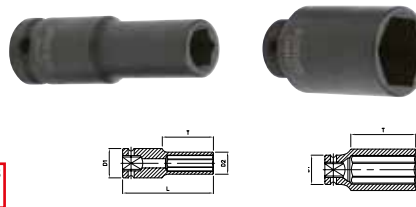

12.5 1/2"

ART.	DIMENSION	L(MM)	G	PREZZO
3358508	8	78	125	€ 11,97
3358509	9	78	125	€ 11,97
3358510	10	78	138	€ 11,97
3358511	11	78	152	€ 11,97
3358512	12	78	160	€ 11,97
3358513	13	78	148	€ 11,97
3358514	14	78	158	€ 11,97
3358515	15	78	168	€ 12,35
3358516	16	78	160	€ 11,97
3358517	17	78	176	€ 12,92
3358518	18	78	214	€ 13,11
3358519	19	78	210	€ 14,06
3358520	20	78	266	€ 14,63
3358521	21	78	238	€ 14,92
3358522	22	78	266	€ 17,48
3358523	23	78	312	€ 17,96
3358524	24	78	384	€ 18,34
3358525	25	78	338	€ 19,10
3358526	26	78	364	€ 19,95
3358527	27	78	346	€ 20,81
3358528	28	78	414	€ 21,95
3358529	29	78	400	€ 21,95
3358530	30	78	422	€ 24,32
3358532	32	78	436	€ 26,89
3358533	33	78	440	€ 30,21
3358534	34	78	480	€ 36,96
3358535	35	78	520	€ 37,53
3358536	36	78	500	€ 36,39
3358538	38	78	600	€ 41,33



- Art. 7110301 Cricchetto "Svita tutto" da 1/4", 72 denti **€ 10,14**
- Art. 7110302 Cricchetto "Svita tutto" da 3/8", 72 denti **€ 10,69**
- Art. 7110303 Cricchetto "Svita tutto" da 1/2", 72 denti **€ 11,77**

CHIAVE A BUSSOLA A MACCHINA 3/4" LUNGA, 6PT. DIN. 3121/3129

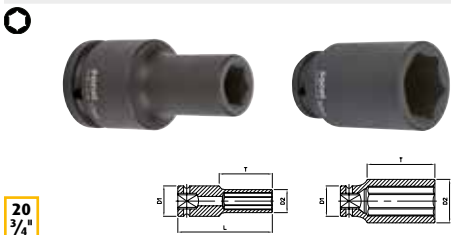

20
3/4"

ART.	DIMENSION	L(MM)	G	PREZZO
3459017	17	90	540	€ 35,42
3459018	18	90	530	€ 35,11
3459019	19	90	550	€ 35,42
3459020	20	90	560	€ 35,11
3459021	21	90	570	€ 35,42
3459022	22	90	590	€ 35,04
3459023	23	90	610	€ 34,80
3459024	24	90	610	€ 34,80
3459025	25	90	620	€ 32,88
3459026	26	90	620	€ 32,88
3459027	27	90	640	€ 34,11
3459028	28	90	644	€ 34,34
3459029	29	90	680	€ 35,11
3459030	30	90	700	€ 36,42
3459032	32	90	730	€ 36,11
3459033	33	90	780	€ 37,50
3459034	34	90	810	€ 39,50
3459035	35	90	810	€ 40,96
3459036	36	90	850	€ 42,58
3459038	38	90	880	€ 46,35
3459039	39	90	920	€ 48,05
3459040	40	90	920	€ 48,36
3459041	41	90	960	€ 50,20
3459042	42	90	1050	€ 52,82
3459043	43	90	1150	€ 52,82
3459044	44	90	1150	€ 54,75
3459045	45	90	1200	€ 60,98
3459046	46	90	1200	€ 58,37
3459047	47	90	1300	€ 60,98
3459048	48	90	1300	€ 62,52
3459050	50	90	1400	€ 63,53
3459052	52	90	1600	€ 74,46
3459054	54	90	1900	€ 79,00
3459055	55	90	1940	€ 80,62

CHIAVE A BUSSOLA A MACCHINA 1" 6PT. DIN. 3121/3129

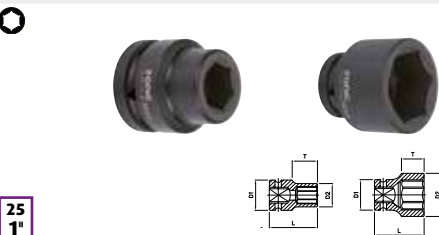

25
1"

ART.	DIMENSION	L(MM)	G	PREZZO
35524	24	58	574	€ 35,28
35525	25	58	570	€ 35,28
35526	26	58	570	€ 34,24
35527	27	58	580	€ 34,24
35528	28	58	580	€ 34,24
35530	30	62	610	€ 34,24
35532	32	62	660	€ 34,24
35533	33	62	682	€ 34,24
35534	34	62	710	€ 34,24
35535	35	62	710	€ 34,24
35536	36	65	720	€ 37,28
35538	38	65	740	€ 39,28
35540	40	65	750	€ 42,00
35541	41	68	792	€ 43,36
35542	42	68	850	€ 46,32
35543	43	68	890	€ 49,68
35544	44	68	930	€ 50,72
35545	45	68	930	€ 50,96
35546	46	72	1010	€ 50,96
35548	48	72	1060	€ 54,32
35550	50	75	1164	€ 59,44
35551	51	75	1250	€ 68,80
35552	52	75	1250	€ 68,80
35553	53	80	1300	€ 71,20
35554	54	80	1400	€ 72,80
35555	55	83	1480	€ 81,92
35557	57	83	1540	€ 81,92
35558	58	83	1650	€ 86,16
35559	59	87	1700	€ 88,88
35560	60	87	1750	€ 94,24
35563	63	87	1800	€ 102,40
35565	65	90	1850	€ 113,04
35566	66	90	1950	€ 113,36
35568	68	93	2000	€ 121,76
35570	70	93	2100	€ 137,84
35571	71	95	2500	€ 137,84
35575	75	95	2800	€ 170,40
35580	80	95	2900	€ 193,20
35585	85	100	3200	€ 222,32
35590	90	105	3800	€ 280,00
35595	95	105	5250	€ 340,40

CHIAVE A BUSSOLA A MACCHINA 1" LUNGA, 6PT. DIN. 3121/3129

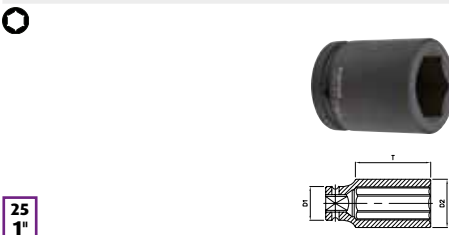

25
1"

ART.	DIMENSION	L(MM)	G	PREZZO
3559024	24	90.0	868	€ 46,00
3559025	25	90.0	850	€ 45,36
3559026	26	90.0	870	€ 45,36
3559027	27	90.0	890	€ 45,36
3559028	28	90.0	890	€ 45,36
3559030	30	90.0	930	€ 44,00
3559032	32	90.0	960	€ 43,68
3559033	33	90.0	1000	€ 43,68
3559034	34	90.0	1000	€ 42,96
3559035	35	90.0	1000	€ 42,96
3559036	36	90.0	1050	€ 44,96
3559038	38	95.0	1150	€ 55,36
3559040	40	95.0	1200	€ 60,08
3559041	41	95.0	1220	€ 61,04
3559042	42	95.0	1250	€ 64,08
3559043	43	95.0	1270	€ 66,08
3559044	44	95.0	1300	€ 69,84
3559045	45	95.0	1300	€ 71,20
3559046	46	95.0	1350	€ 71,84
3559048	48	100.0	1500	€ 76,16
3559050	50	100.0	1600	€ 79,52
3559051	51	100.0	1650	€ 80,80
3559052	52	100.0	1650	€ 86,88
3559053	53	100.0	1700	€ 89,28
3559054	54	100.0	1750	€ 89,52
3559055	55	105.0	1900	€ 105,68
3559057	57	105.0	1950	€ 116,08
3559058	58	105.0	2000	€ 117,12
3559059	59	110.0	2050	€ 118,08
3559060	60	110.0	2100	€ 132,48
3559063	63	110.0	2200	€ 147,60
3559065	65	115.0	2350	€ 171,44
3559066	66	115.0	2450	€ 172,08
3559068	68	120.0	2550	€ 186,48
3559070	70	120.0	2650	€ 193,84
3559071	71	135.0	3000	€ 201,28
3559075	75	135.0	4000	€ 233,68
3559076	76	135.0	4000	€ 234,80
3559080	80	135.0	4500	€ 273,04
3559085	85	140.0	5250	€ 384,00
3559090	90	140.0	5750	€ 494,64
3559095	95	140.0	6300	€ 585,20



Art. 7120101
Cricchetto nano 1/4", 45-denti
Art. 7120102
Cricchetto nano 3/8", 45-denti

€ 25,93
€ 30,26



Art. 7120901
Cricchetto 1/4", 45-denti
Art. 7120902
Cricchetto 3/8", 45-denti
Art. 7120903
Cricchetto 1/2", 45-denti

€ 26,83
€ 31,79
€ 36,80



Art. 7110101
Cricchetto flessibile 1/4", 45-denti
Art. 7110102
Cricchetto flessibile 3/8", 45-denti
Art. 711013300
Cricchetto flessibile 1/2", 45-denti 300mm
Art. 711013440
Cricchetto flessibile 1/2", 45-denti 440mm

€ 29,90
€ 37,07
€ 41,50
€ 48,84



Art. 7120701
Cricchetto 1/4", 72-denti
Art. 7120702
Cricchetto 3/8", 72-denti
Art. 7120703
Cricchetto 1/2", 72-denti

€ 20,88
€ 26,65
€ 33,87



Art. 7110201
Cricchetto rotante 1/4", 72-denti
Art. 7110202
Cricchetto rotante 3/8", 72-denti
Art. 7110203
Cricchetto rotante 1/2", 72-denti

€ 26,38
€ 34,05
€ 39,91



Art. 7110402
Cricchetto rotante nano 3/8", 72-denti
Art. 7110403
Cricchetto rotante nano 1/2", 72-denti

€ 28,91
€ 33,51

CHIAVE A FORCHETTA DOPPIA

DIN. 3110



ART.	DIMENSION	G	PREZZO
4140607	6X7	22	€ 5,25
4140809	8X9	32	€ 5,94
4141011	10X11	58	€ 6,53
4141213	12X13	80	€ 7,26
4141415	14X15	98	€ 7,69
4141617	16X17	134	€ 9,27
4141819	18X19	158	€ 11,29
4142022	20X22	212	€ 13,29
4142123	21X23	232	€ 14,90
4142224	22X24	225	€ 14,90
4142427	24X27	314	€ 18,73
4142528	25X28	386	€ 20,71
4143032	30X32	486	€ 23,57
4143436	34X36	600	€ 37,51

CHIAVE COMBINATA

DIN. 3113



ART.	DIMENSION	G	PREZZO
41506	6	14	€ 5,90
41507	7	20	€ 6,19
41508	8	30	€ 6,34
41509	9	32	€ 6,48
41510	10	38	€ 7,06
41511	11	50	€ 7,34
41512	12	66	€ 7,63
41513	13	70	€ 8,21
41514	14	84	€ 8,71
41515	15	94	€ 9,50
41516	16	108	€ 10,37
41517	17	128	€ 11,81
41518	18	148	€ 12,74
41519	19	160	€ 14,26
41520	20	178	€ 15,77
41521	21	210	€ 16,63
41522	22	250	€ 17,06
41523	23	254	€ 18,72
41524	24	328	€ 19,80
41525	25	314	€ 21,24
41526	26	348	€ 22,61
41527	27	380	€ 24,62
41528	28	430	€ 25,56
41529	29	436	€ 27,79
41530	30	530	€ 30,02
41532	32	570	€ 31,90
41533	33	630	€ 45,92
41534	34	630	€ 45,92
41535	35	800	€ 49,00
41536	36	800	€ 49,00
41538	38	1000	€ 68,43
41541	41	1160	€ 81,48
41543	43	1160	€ 81,48
41546	46	1700	€ 102,87
41548	48	2000	€ 143,19
41550	50	2000	€ 143,19
41555	55	2800	€ 296,30
41558	58	3900	€ 355,49
41560	60	3900	€ 355,49
41565	65	5800	€ 473,98
41570	70	5800	€ 473,98
41575	75	6650	€ 668,30
41580	80	6650	€ 691,99

CHIAVE COMBINATA

DIN. 3113



ART.	DIMENSION	G	PREZZO
41706	6	12	€ 6,41
41707	7	18	€ 6,55
41708	8	26	€ 6,77
41709	9	34	€ 7,06
41710	10	40	€ 8,06
41711	11	50	€ 8,64
41712	12	60	€ 9,36
41713	13	72	€ 10,30
41714	14	84	€ 11,27
41715	15	100	€ 12,10
41716	16	110	€ 13,14
41717	17	146	€ 14,18
41718	18	165	€ 15,48
41719	19	180	€ 17,14
41720	20	195	€ 18,36
41721	21	217	€ 19,44
41722	22	258	€ 20,45
41723	23	287	€ 22,52
41724	24	314	€ 23,70
41725	25	350	€ 25,16
41726	26	386	€ 26,81
41727	27	443	€ 28,89
41728	28	472	€ 29,89
41729	29	530	€ 32,41
41730	30	601	€ 34,86
41732	32	697	€ 37,06

75° CHIAVE DOPPIA CURVATA 12PT.

DIN. 838



ART.	DIMENSION	G	PREZZO
4190607	6X7	52	€ 8,72
4190809	8X9	56	€ 9,58
4191011	10X11	94	€ 11,29
4191213	12X13	122	€ 12,44
4191415	14X15	164	€ 14,40
4191617	16X17	196	€ 14,70
4191819	18X19	260	€ 16,96
4192022	20X22	320	€ 19,58
4192122	21X22	382	€ 19,58
4192123	21X23	344	€ 22,02
4192326	23X26	490	€ 25,68
4192427	24X27	498	€ 25,68
4192528	25X28	546	€ 26,78
4193032	30X32	632	€ 31,35
4193436	34X36	1000	€ 62,04

CHIAVE A CRICCHETTO COMBINATA REVERSIBILE 12PT.



ART.	DIMENSION	G	PREZZO
4170208	8	36	€ 22,70
4170209	9	44	€ 22,97
4170210	10	58	€ 23,69
4170211	11	70	€ 24,75
4170212	12	84	€ 26,00
4170213	13	100	€ 26,93
4170214	14	116	€ 28,12
4170215	15	140	€ 29,83
4170216	16	158	€ 34,12
4170217	17	200	€ 34,25
4170218	18	202	€ 34,45
4170219	19	250	€ 35,84
4170221	21	358	€ 47,19
4170222	22	361	€ 47,39
4170224	24	484	€ 56,89
4170227	27	632	€ 74,32

CHIAVE COMBINATA EXTRA LUNGA



ART.	DIMENSION	G	PREZZO
4150310	10	50	€ 13,75
4150311	11	80	€ 14,47
4150312	12	90	€ 15,98
4150313	13	100	€ 17,57
4150314	14	150	€ 20,88
4150315	15	170	€ 22,68
4150316	16	200	€ 24,98
4150317	17	230	€ 27,07
4150318	18	270	€ 28,94
4150319	19	300	€ 32,69

CHIAVE COMBINATA CORTA



ART.	DIMENSION	G	PREZZO
42608	8	20	€ 6,98
42609	9	20	€ 7,49
42610	10	30	€ 7,49
42611	11	30	€ 8,06
42612	12	40	€ 8,78
42613	13	40	€ 8,86
42614	14	40	€ 9,43
42615	15	40	€ 10,44
42616	16	45	€ 11,52
42617	17	50	€ 12,82

CHIAVE TX DOPPIA DRITTA



ART.	DIMENSION	G	PREZZO
4160608	E6XE8	22	€ 16,75
4160711	E7XE11	24	€ 18,28
4161012	E10XE12	42	€ 19,47
4161418	E14XE18	82	€ 21,00
4161622	E16XE22	116	€ 22,70
4162024	E20XE24	200	€ 24,99

CHIAVE A MEZZALUNA 12PT.



ART.	DIMENSION	G	PREZZO
4211012	180	200	€ 15,41
4211113	250	335	€ 19,30
4211417	400	1065	€ 23,76

CHIAVE AD ANELLO APERTA

DIN. 838



ART.	DIMENSION	G	PREZZO
4110810	8X10	52	€ 9,86
4111113	11X13	84	€ 12,41
4111214	12X14	116	€ 12,58
4111618	16X18	130	€ 15,81
4111719	17X19	184	€ 16,92
4111922	19X22	244	€ 20,83
4112427	24X27	342	€ 28,39
4113032	30X32	470	€ 34,68
4113641	36X41	470	€ 68,92

PINZE A BECCHI MEZZOTONDI LUNGI DRITTI 8"



ART.	L(MM)	G	PREZZO
4321200	205	218	€ 24,27

PINZE COMBinate 7"



ART.	L(MM)	G	PREZZO
4311175	185	302	€ 22,03

PINZE A BECCHI MEZZOTONDI LUNGI DRITTI 6" (GERMANIA)



ART.	L(MM)	G	PREZZO
4321170	170	156	€ 23,63

TRONCHESE A TAGLIENTE DIAGONALE UNIVERSALE (GERMANIA)



ART.	L(MM)	G	PREZZO
4341190	180	130	€ 38,95

PINZA DI LIVELLAMENTO DIAGONALE 8" (GERMANIA)



ART.	L(MM)	G	PREZZO
4342200	210	308	€ 40,46

TRONCHESE A TAGLIANTI DIAGONALI 9" (GERMANIA)



ART.	L(MM)	G	PREZZO
4342240	250	410	€ 39,90

PINZE A TAGLIETE LATERALE HEAVY DUTY 7"



ART.	L(MM)	G	PREZZO
4343200	210	290	€ 33,84

PINZA REGOLABILE 7" (GERMANIA)



ART.	L(MM)	G	PREZZO
4351180	180	145	€ 21,15
4351250	250	322	€ 16,29
4351300	300	580	€ 37,11
4351400	400	1305	€ 55,47

PINZA REGOLABILE MX, 180MM 10" (GERMANIA)



ART.	L(MM)	G	PREZZO
4352180	180	200	€ 28,50
4352250	250	335	€ 32,25
4352300	300	530	€ 38,79
4352400	400	1065	€ 79,64

FORBICI



ART.	L(MM)	G	PREZZO
46704	190	135	€ 18,30

PINZA A BECCHI PIATTI ESO



ART.	L(MM)	G	PREZZO
4324115	115	70	€ 37,98

PINZA A BECCHI MEZZOTONDI PIEGATI ESO



ART.	L(MM)	G	PREZZO
4325115	115	70	€ 39,17

TRONCHESE ESD



ART.	L(MM)	G	PREZZO
4344115	115	80	€ 42,36
4345115	115	70	€ 44,43

PINZA A BECCHI DRITTI PER ANELLI ELASTICI (INTERNI)



ART.	L(MM)	G	PREZZO
43612	178	150	€ 17,80

PINZA PER ANELLI ELASTICI CIRCLIPS



ART.	L(MM)	G	PREZZO
4393004	220	250	€ 26,67

PINZA A BECCHI PIEGATI A 90° PER ANELLI ELASTICI (INTERNI)



ART.	L(MM)	G	PREZZO
43614	167	150	€ 17,08

PINZA A BECCHI CURVI PER ANELLI ELASTICI (ESTERNI)



ART.	L(MM)	G	PREZZO
4393006	200	255	€ 23,34

PINZA A BECCHI DRITTI PER ANELLI ELASTICI (ESTERNI)

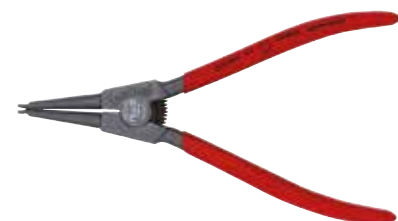

ART.	L(MM)	G	PREZZO
43611	178	150	€ 16,45

PINZA A BECCHI DRITTI PER ANELLI ELASTICI (ESTERNI)



ART.	L(MM)	G	PREZZO
4393005	220	240	€ 24,31

PINZA A BECCHI PIEGATI A 90° PER ANELLI ELASTICI (ESTERNI)



ART.	L(MM)	G	PREZZO
43613	167	150	€ 18,04

PINZA A BECCHI CURVI PER ANELLI ELASTICI (ESTERNI)



ART.	L(MM)	G	PREZZO
4393007	200	255	€ 26,34

PINZA GIRATUBO 90°



ART.	L(MM)	G	PREZZO
47034340	310	785	€ 55,26
47034550	560	2690	€ 108,39
47034680	650	3450	€ 200,14

TAGLIATUBI IN PLASTICA



ART.	L(MM)	G	PREZZO
47033	210	785	€ 71,34

SCALPELLO CON IMPUGNATURA



ART.	L(MM)	G	PREZZO
45110141	140	60	€ 9,90
45112160	160	96	€ 11,03
45116170	170	116	€ 11,33
45118190	190	196	€ 15,23
45124220	220	350	€ 19,80

SCALPELLO A PUNTA CON IMPUGNATURA



ART.	L(MM)	G	PREZZO
4527190	190	186	€ 13,50

SCALPELLO PIATTO 240MML



ART.	L(MM)	G	PREZZO
4831101	240	370	€ 15,31

CACCIASPINE CON IMPUGNATURA



ART.	L(MM)	G	PREZZO
4532140	140	50	€ 8,10
4533150	150	54	€ 8,55
4534180	180	88	€ 9,90
4535200	200	102	€ 10,28
4536210	210	182	€ 12,98
4538220	220	176	€ 14,78
45310230	230	176	€ 15,37
45312250	250	176	€ 18,84
45314290	290	176	€ 20,81
45316310	310	176	€ 26,57

PUNZONE CONICO CON IMPUGNATURA



ART.	L(MM)	G	PREZZO
4552185	185	98	€ 10,43
4553185	185	100	€ 10,43
4554185	185	102	€ 10,43

PUNZONE DI CENTRAGGIO CON IMPUGNATURA



ART.	L(MM)	G	PREZZO
4564185	185	102	€ 10,43

PUNZONE DI CENTRAGGIO AUTOMATICO



ART.	L(MM)	G	PREZZO
45602	155	37	€ 31,65

SEGNETTO HEAVY DUTY



ART.	L(MM)	G	PREZZO
46601	415	962	€ 36,20

MARTELLO TEDESCO CON MANICO IN FIBRA DI VETRO E RIVESTIMENTO



ART.	L(MM)	G	PREZZO
4611200	287	262	€ 8,54
4611300	300	380	€ 10,14
4611400	311	512	€ 11,02
4640500	347	630	€ 11,98
4640600	360	760	€ 14,05
4640800	383	994	€ 16,05
4621000	366	1166	€ 18,76
4641500	422	1672	€ 23,47
4642000	447	2170	€ 27,78

MARTELLO TEDESCO



ART.	L(MM)	G	PREZZO
4631000	278	1106	€ 14,86

MAZZETTA CON BATTENTI IN MATERIALE PLASTICO 35MM



ART.	L(MM)	G	PREZZO
4822102	300	368	€ 22,51
4620400	295	604	€ 25,31

MAZZETTA 1340GR. CON BATTENTE IN NYLON, MANICO IN LEGNO



ART.	L(MM)	G	PREZZO
4652035	335	610	€ 37,76
4652060	355	1340	€ 63,90

**TROVIAMO SEMPRE
UNA SOLUZIONE**

SONIC

MOTORE DI RICERCA MESSA IN FASE SONIC

Vogliamo aiutarti a trovare il corretto strumento per il tuo lavoro. Compila il form qui sotto riportato con la lista degli strumenti di messa in fase per il tuo veicolo e dove possibile Sonic risponderà alle vostre esigenze.

Marca:	<input type="text"/>	-	Conosci il codice motore e il codice OEM ?
Modello:	<input type="text"/>	-	Compila i campi qui sotto per avere la lista degli strumenti necessari.
Anno:	<input type="text"/>	-	
Cilindrata:	<input type="text"/>	-	Codice motore: <input type="text"/>
Codice motore:	<input type="text"/>	-	Codice OEM: <input type="text"/>

TROVARE STRUMENTO

RESET



i Maggiori informazioni su www.sonic-equipment.com

Grazie all'accurato database, basato su autodata, contenente gli utensili di messa in fase troverai l'utensile adatto ai tuoi lavori cercando per: codice oem, selezione del veicolo o codice motore.

Sul sito o sul catalogo troverai un'ampia gamma di prodotti



BMW - Mini

829027
KIT DI MESSA IN FASE MOTORI BMW DIESEL M47 - 2,0



BMW
€ 164,94

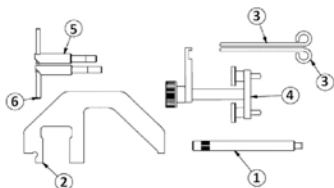

ART.	OEM
1	4880018 11-2-300, LRT-12-108, LRT-12-171
2	4880022 11-6-320
3	4880024 11-3-340
4	4880023 11-6-322
5	4880038 11 5 180, LRT 12-227
6	4880039 11 6 080

829029
KIT DI MESSA IN FASE MOTORI BMW A BENZINA N43 - 1,6/2,0



BMW
€ 238,70

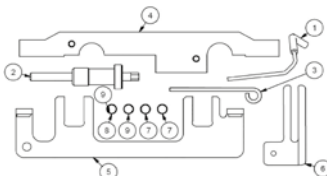

ART.	OEM
1	4880025 11 5 120
2	4880026 11 9 340
3	4880024 11 3 340
4	4880257 11 8 710 (11 8 711 11 8 712)
5	4880256 11 8 690 (11 8 691 11 8 692, 11 8 693)
6	4880258 11 8 700
7	4880169 -
8	4880028 -
9	4880010 -

829031
KIT DI MESSA IN FASE MOTORI BMW A BENZINA N42/46 - 1,6/1,8/2,0

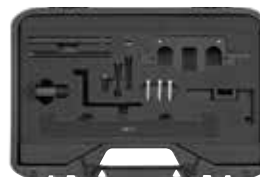

BMW
€ 260,38

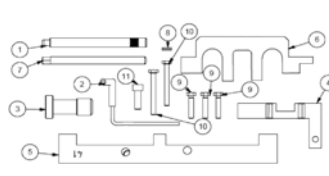

ART.	OEM
1	4880018 11 5 120, 11 2 300
2	4880025 11 9 190
3	4880020 11 9 340
4	4880029 11 9 292
5	4880043 11 9 350
6	4880027 11 9 291
7	4880021 -
8	4880010 -
9	4880028 -
10	4880114 -
11	4880165 -

829028
KIT DI MESSA IN FASE MOTORI BMW A BENZINA N51/52/53/54 - 2,3/2,5/2,8/3,0



BMW
€ 417,55

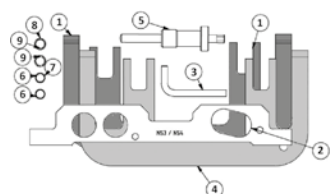

ART.	OEM
1	4880259 11 4 280, 11 4 281, 11 4 282, 11 4 283, 11 4 285
2	4880060 11 4 290, 11 8 520
3	4880059 11 0 300
4	4880261 11 4 280, 11 4 281, 11 4 283
5	4880026 11 9 340
6	4880028 -
7	4880010 -
8	4880047 -
9	4880211 -

829030
KIT DI MESSA IN FASE MOTORI BMW/PSA A BENZINA N12/N14 - 1,4/1,6



BMW
€ 421,13

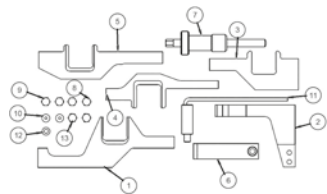

ART.	OEM
1	4880035 11 9 540 / 0197-A3
2	4880034 119540 / 0197-A3
3	4880036 11 9 540 / 0197-A1
4	4880030 11 9 550 / 0197-A2
5	4880031 11 9 551
6	4880032 11 9 552
7	4880026 11 9 340
8	4880134 -
9	4880028 -
10	4880322 -
11	4880033 11 9 590 / 0197-B
12	4880181 -
13	4880216 -

829032
KIT DI MESSA IN FASE MOTORI BMW A BENZINA N40/45/45T - 1.6



BMW
€ 256,50

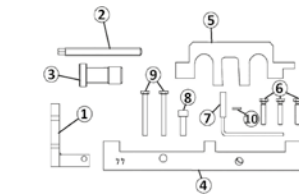

ART.	OEM
1	4880042 11 7 252
2	4880019 -
3	4880020 11 9 340, 11 9 341
4	4880040 11 7 260
5	4880041 11 7 251
6	4880028 -
7	4880025 11 9 190
8	4880165 -
9	4880114 -
10	4880010 -

829033
KIT DI MESSA IN FASE MOTORI
BMW/MINI DIESEL N47/47S - 2,0

BMW - MINI

€ 116,43

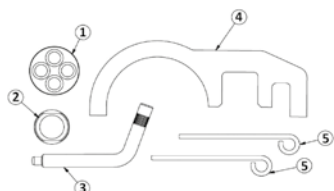

ART.	OEM
1	4880044 11 6 480
2	4880045 11 8 740
3	4880046 11 5 320
4	4880037 11 8 760
5	4880024 11 3 340

829101
KIT REGOLAZIONE EQUILIBRATURA DELL'ALBERO MOTORE
BMW PETROL N40/42/43/45/46/49/52 -

BMW

€ 92,04

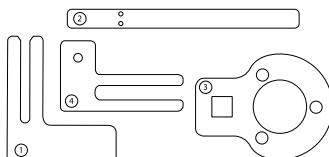

ART.	OEM
1	4880286 11 8 700
2	4880287 11 5 140
3	4880288 11 9 280
4	4880258 11 9 330

829104
CHIAVE CINGHIA DI TRASMISSIONE MOTORE
BENZINA BMW MINI - 1,6

BMW - MINI

€ 175,58

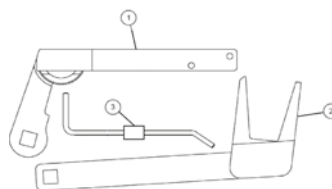

ART.	OEM
1	4880138 11 8 410
2	4880139 11 8 390
3	4880002, 4880003 11 8 470 & 11 8 280

829034
KIT DI MESSA IN FASE MOTORI BMW A BENZINA N62/73 -
3,6/4,0/4,4/4,8/6,0 V8

BMW

€ 225,19

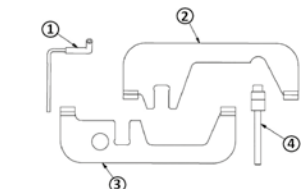
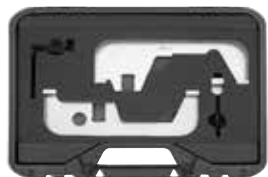

ART.	OEM
1	4880025 11 9 190
2	4880207 11 9 461
3	4880208 11 9 462
4	4880209 11 9 463

829102
STRUMENTO DI CONTROLLO TENUTA ALBERO MOTORE
BMW DIESEL N47/57 - 1,6/2,0/3,0

BMW

€ 66,56

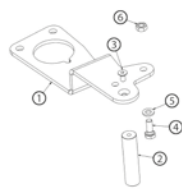

ART.	OEM
1	4880301 11 4 320
2	4880302 -
3	4880110 -
4	4880169 -
5	4880010 -
6	4880328 -

829105
STRUMENTO CONTROLLO TENUTA DELLA PULEGGIA
ANTERIORE BMW DIESEL N47

BMW

€ 88,58

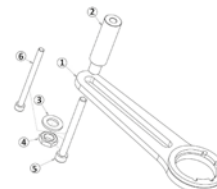

ART.	OEM
1	4880221 11 7 220
2	4880220 -
3	4880333 -
4	4880327 -
5	4880213 -
6	4880217 -

829097
KIT REGOLAZIONE EQUILIBRATURA DELL'ALBERO MOTORE
BMW DIESEL N47 - 2,0

BMW

€ 240,99

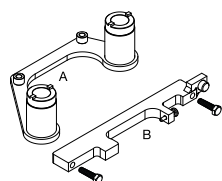

ART.	OEM
A	4880291 11 8 750
B	4880292 11 8 790, 11 8 791, 11 8 793

829121
KIT BLOCCAGGIO CATENA DISTRIBUZIONE
PSA / BMW 1,4 / 1,6 BENZINA



BMW
€ 527,75

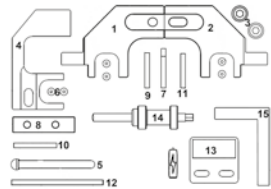

ART.	OEM
1	4880375 0197-A1/A1Z, 0197-A11, 11 7 440, 11 9 551, 11 9 540
2	4880372 0197-A2, 11 9 551
3	4880349 -
4	4880378 0197-A3, 0197-031, 11 7 440, 11 9 540
5	4880358 0197-BZ, 11 9 590, 49 6 709, 2 299 362
6	4880416 -
7	4880373 0197-A1/AZ, 11 9 540
8	4880380 Barra collegamento per A e B
9	4880377 0197-A2, 11 9 551
10	4880379 0197-A31, 11 7 440
11	4880374 0197-A11, 11 9 551, 11 9 440
12	4880379 0197-A3, 11 9 540
13	4880415 G-1376-A
14	4880371 0197-M, 11 9 340
15	4880415 E1.100

829131
KIT REGOLAZIONE EQUILIBRATURA DELL'ALBERO
MOTORE BMW B47/B48N47



BMW
€ 276,00

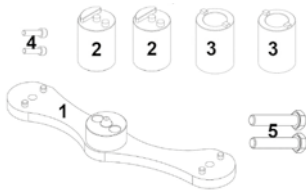

ART.	OEM
1	4880404 Contralbero di equilibratura
2	4880405 2 288 054
3	4880406 11 8 750
4	4880353 Vite testa cilindrica M8x3
5	4880346 Vite testa esagonale M10x50

Chevrolet Chrysler Dodge

829017
KIT DI MESSA IN FASE MOTORI OPEL/CHEVROLET/FIAT A
BENZINA - 1,6/1,8 16V



CHEVROLET
€ 102,75

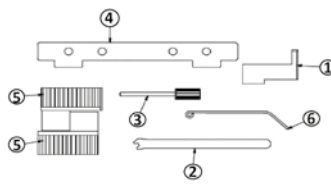

ART.	OEM
1	4880234 KM-6625
2	4880168 KM-911
3	4880185 KM6130, KM6349
4	4880239 KM-6628A, 2 000 012 000
5	4880057 KM-6340, 2 000 012 100
6	4880058 KM-6333

829061
KIT DI MESSA IN FASE MOTORI OPEL/CHEVROLET DIESEL
(Z20) - 2,0



CHEVROLET
€ 96,56

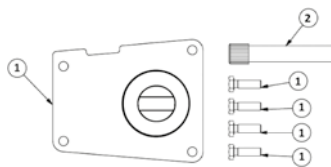

ART.	OEM
1	4880012 EN-48245
2	4880011 EN-48246

829064
KIT DI MESSA IN FASE MOTORI OPEL/CHEVROLET/SAAB A
BENZINA (A20/A24) - 2,0, 2,4



CHEVROLET
€ 384,77

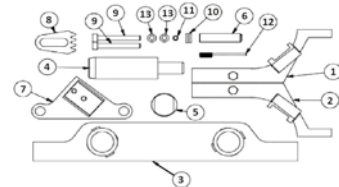

ART.	OEM
1	4880231 EN-49212, EN-49212-1
2	4880232 EN-49212, EN-49212-2
3	4880317 EN-48953
4	4880318 EN-48585
5	4880320 J45027-2, EN45027-2, EN-45027,
6	4880321 EN-45027-1, J-45027-1
7	4880319 EN-43653, J43653
8	4880135 EN-43653, J43653
9	4880214 -
10	4880010 -
11	4880173 EN-955-20, KM 955-20
12	4880172 EN-955-10, KM955
13	4880215 -

829083
KIT DI MESSA IN FASE MOTORI CHRYSLER/LDV DIESEL CRD -
2,5, 2,8



CHRYSLER
€ 152,32

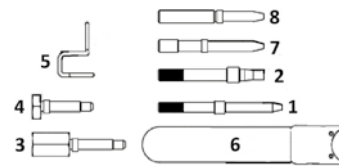

ART.	OEM
1	4880222 VM.1089, LDV196
2	4880223 VM.1068, LDV196
3	4880224 VM.1052, LDV192
4	4880225 VM.1053, LDV193
5	4880226 VM1074
6	4880015 VM.9660, H2587
7	4880282 VM.1080
8	4880283 VM.8873

829084
KIT DI MESSA IN FASE MOTORI CHRYSLER/JEEP
DIESEL CRD - 2,8

CHRYSLER

€ 64,00

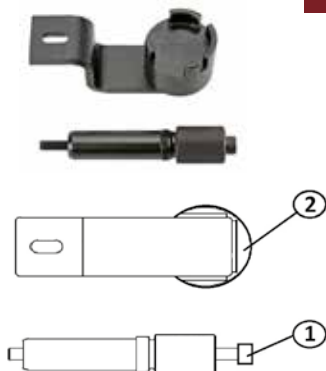

ART.	OEM
1 4880284	VM.9992
2 4880285	VM.9991

829085
KIT DI MESSA IN FASE MOTORI CHRYSLER/JEEP
DIESEL CRD - 3,0

CHRYSLER

€ 261,99

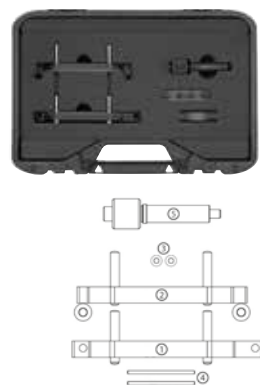

ART.	OEM
1 4880311	VM10338-1
2 4880310	VM10338-2
3 -	-
4 4880313	VM10359a
5 4880312	VM10339

829086
KIT DI MESSA IN FASE MOTORI MERCEDES/
CHRYSLER CRD - 2,2/2,7

CHRYSLER

€ 202,37

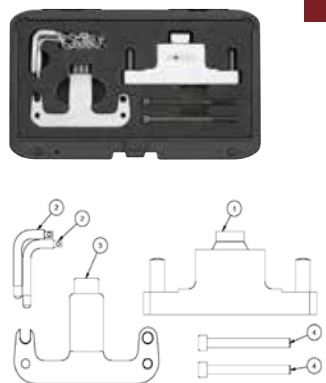

ART.	OEM
1 4880311	VM10338-1
2 4880310	VM10338-2
3 -	-
4 4880313	VM10359a

Fiat Alfa Romeo

829015
KIT DI MESSA IN FASE MOTORI FIAT/OPEL/SAAB JTD DIESEL -
1,6/1,9/2,0/2,4

FIAT

€ 105,79



ART.	OEM
1 4880188	1.870.896.900, EN-46789, 32 025 008
2 4880136	1.860.898.000
3 4880137	-
4 4880218	-
5 4880091	1.860.965.000
6 4880187	1.860.905.000, 1.860.905.010, 2.000.003.000, EN-46788, 32 025 009

829016
KIT DI MESSA IN FASE E RIGENERAZIONE MOTORI
DIESEL JTD FIAT/OPEL/FORD/PSA - 1.3

FIAT

€ 199,66

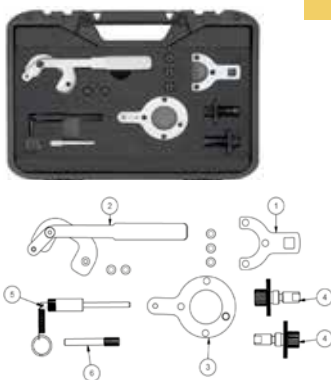

ART.	OEM
1 4880200	1 871 000 200, 303-1469, KM-662-C
2 4880004	1 870 900 400
3 4880005	0104-C, 1 870 900 300, 303-1468
4 4880183	0104-A, 1 871 000 900, 1 860 985 000, EN 46781, 09917-68610
5 4880186	EN 46785, 09912-38300
6 4880096	Perno di bloccaggio 8mm

829017
KIT DI MESSA IN FASE MOTORI OPEL/CHEVROLET/FIAT A
BENZINA - 1,6/1,8 16V

FIAT, ALFA ROMEO

€ 102,75

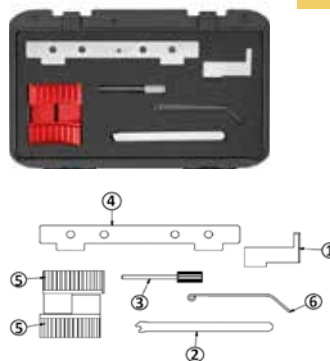

ART.	OEM
1 4880234	KM-6625
2 4880168	KM-911
3 4880185	KM6130, KM6349
4 4880239	KM-6628A, 2 000 012 000
5 4880057	KM-6340, 2 000 012 100
6 4880058	KM-6333

829018
KIT DI MESSA IN FASE MOTORI FIAT/PSA/IVECO
JTD DIESEL - 2.8

FIAT

€ 99,63

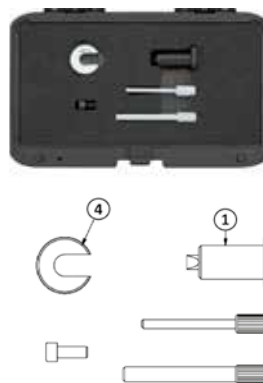

ART.	OEM
1 4880237	1 870 765 001
2 4880090	1 860 617 000
3 4880097	Perno di bloccaggio 8mm
4 4880132	1 860 638 000

829019
KIT DI MESSA IN FASE MOTORI FIAT T JET
A BENZINA - 1,2/1,4



FIAT
€ 199,29

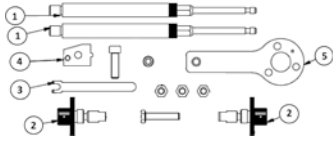

ART.	OEM
1	4880182 1 860 992 000
2	4880183 1 860 985 000, 1 871 000 900
3	4880184 1 860 987 000
4	4880233 2 000 015 800
5	4880006 2 000 004 500

829021
KIT DI MESSA IN FASE MOTORI FIAT TWINAIR
A BENZINA - 0,9



FIAT, ALFA ROMEO
€ 84,27

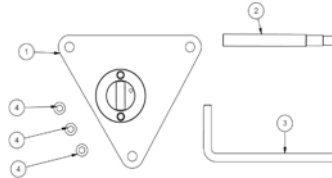

ART.	OEM
1	4880266 2 000 035 100
2	4880265 2 000 035 200
3	4880264 2 000 035 300
4	4880165 -
5	4880218 -

829023
KIT DI MESSA IN FASE MOTORI FORD/PSA/FIAT TDCI/HDI
DIESEL - 1,4/1,5/1,6



FIAT
€ 104,51

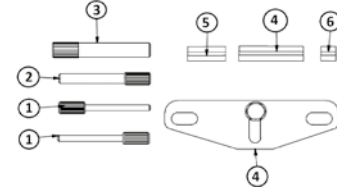

ART.	OEM
1	4880090 303-732, 21-260
2	4880096 303-735, 21-263
3	4880064 303-734, 21-262
4	4880061 303-393, 21-168
5	4880062 303-393-01
6	4880063 303-293-02

829020
KIT DI MESSA IN FASE MOTORI FIAT MULTIAIR
A BENZINA - 1,4



FIAT
€ 109,70

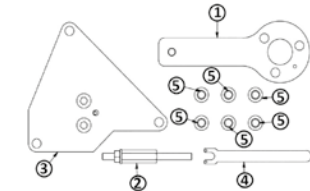

ART.	OEM
1	4880006 2 000 004 500
2	4880137 2 190 754 200
3	4880263 2 000 034 400
4	4880184 1 860 987 000
5	4880218 -

829022
UTENSILE DI BLOCCAGGIO ALBERO MOTORE DOPPIO
OPEL/FIAT/RENAULT A BENZINA - 2,2



FIAT
€ 97,29

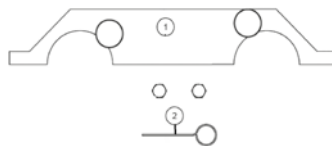

ART.	OEM
1	4880179 KM 6148
2	4880180 KM 6077

829024
KIT DI MESSA IN FASE MOTORI FIAT/FORD A BENZINA - 1.2 8V

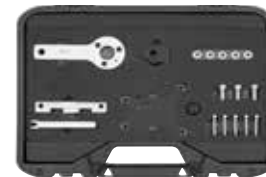

FIAT
€ 200,90

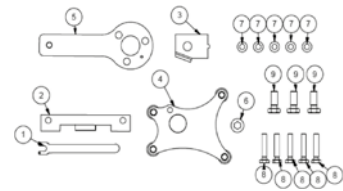

ART.	OEM
1	4880184 1 860 987 000
2	4880007 2 000 004 400, 2 190 754 400
3	4880008 2 000 004 200, 2 190 754 200
4	4880009 2 000 004 300
5	4880006 2 000 004 500, 2 190 754 500
6	4880202 -
7	4880010 -
8	4880329 -
9	4880332 -

829025
KIT DI MESSA IN FASE MOTORI FIAT JTD DIESEL - 2,3/3,0



FIAT
€ 103,78

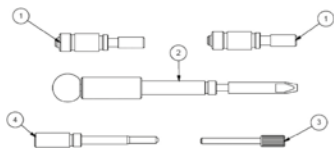

ART.	OEM
1 4880130	99360614
2 4880131	99360615
3 4880090	1 860 617 000
4 4880001	2 000 018 200

829039
KIT DI MESSA IN FASE MOTORI FIAT/OPEL/FORD/PSA JTD DIESEL - 1,3



FIAT
€ 187,62

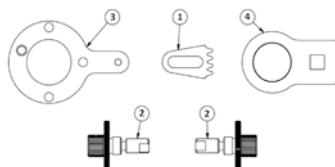

ART.	OEM
1 4880135	153A
2 4880183	21 860 985 000, EN 46781, 303-1472, 0104-A
3 4880005	1 870 900 300, 303-1468, 0104-C
4 4880280	303-1475, 1 871 008 600

829063
KIT DI MESSA IN FASE MOTORI OPEL/FIAT/FORD/PSA DIESEL JTD/HDI - 1,3



FIAT
€ 106,46

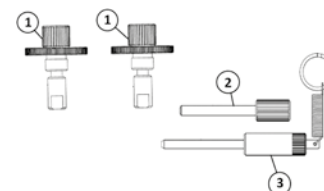

ART.	OEM
1 4880072	7099-TM
2 4880112	0188K, 0132AK, 0153AK, 0187J, 4533-TAD
3 4880113	0188P, 7015-T, 0188P2

829026
KIT DI MESSA IN FASE MOTORI FIAT/PSA/OPEL/IVECO JTD DIESEL - 2,5



FIAT
€ 35,83

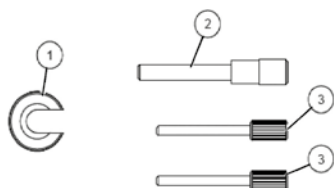

ART.	OEM
1 4880132	1 860 638 000
2 4880095	1 870 667 000, 1 870 765 001
3 4880090	1 860 617 000

829041
KIT DI MESSA IN FASE E RIGENERAZIONE MOTORI PSA/FIAT DW10/DW12 - 2.0/2.2



FIAT
€ 223,78

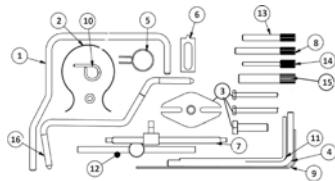

ART.	OEM
1 4880072	7099-TM
2 4880112	0188K, 0132AK, 0153AK, 0187J, 4533-TAD
3 4880113	0188P, 7015-T, 0188P2
4 4880068	303-1059
5 4880080	0188AH
6 4880106	0188F
7 4880108	0188J2
8 4880097	0188M
9 4880227	0188Q2
10 4880228	0153AL
11 4880060	0188Q1
12 4880104	0188JJ1
13 4880096	0189B
14 4880090	0178D, 303-732, 0194A
15 4880064	303-734, 0194C
16 4880255	0.532Y, 9967.34

829088
STRUMENTO DI TENUTA ALBERO MOTORE FIAT/FORD/OPEL DIESEL JTD - 1,3



FIAT
€ 61,13

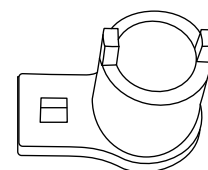

ART.	OEM
1 829088	1 871 008 600 303-1475

Ford

829016

KIT DI MESSA IN FASE E RIGENERAZIONE MOTORI DIESEL JTD FIAT/OPEL/FORD/PSA - 1.3



FORD
€ 199,66

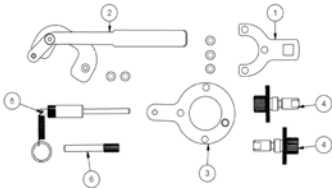

ART.	OEM
1	4880200 1 871 000 200, 303-1469, KM-662-C
2	4880004 1 870 900 400
3	4880005 0104-C, 1 870 900 300, 303-1468
4	4880183 0104-A, 1 871 000 900, 1 860 985 000, EN 46781, 09917-68610
5	4880186 EN 46785, 09912-38300
6	4880096 Perno di bloccaggio 8mm

829023

KIT DI MESSA IN FASE MOTORI FORD/PSA/FIAT TDCI/HDI DIESEL - 1,4/1,5/1,6



FORD
€ 104,51

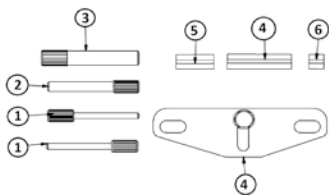

ART.	OEM
1	4880090 303-732, 21-260
2	4880096 303-735, 21-263
3	4880064 303-734, 21-262
4	4880061 303-393, 21-168
5	4880062 303-393-01
6	4880063 303-293-02

829024

KIT DI MESSA IN FASE MOTORI FIAT/FORD A BENZINA - 1.2 8V

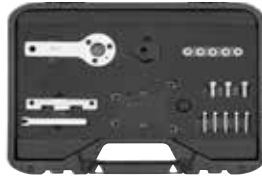

FORD
€ 200,90

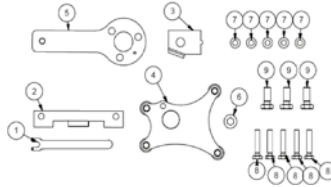

ART.	OEM
1	4880184 1 860 987 000
2	4880007 2 000 004 400, 2 190 754 400
3	4880008 2 000 004 200, 2 190 754 200
4	4880009 2 000 004 300
5	4880006 2 000 004 500, 2 190 754 500
6	4880202 -
7	4880010 -
8	4880329 -
9	4880332 -

829042

KIT DI MESSA IN FASE MOTORI FORD DIESEL TDCI - 2,2/3,2



FORD
€ 99,13

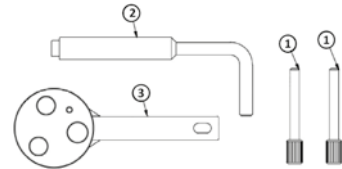

ART.	OEM
1	4880091 Perno di bloccaggio 8mm 2 pz.
2	4880066 303-698 / 21-251
3	4880273 303-1587

829040

KIT DI MESSA IN FASE MOTORI JAGUAR LAND ROVER/FORD/PSA DIESEL DW12 - 2,2



FORD
€ 93,28

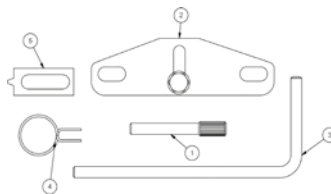

ART.	OEM
1	4880096 303-1277, 0188.M
2	4880061 303-1272, 0188.F
3	4880068 303-1270, 303-1059
4	4880080 0188AH
5	4880106 0188F

829043

KIT DI MESSA IN FASE MOTORI FORD DURATORQ (TDCI) BELT DRIVEN DIESEL 1.4/1.6/1.8/2.0



FORD
€ 404,77

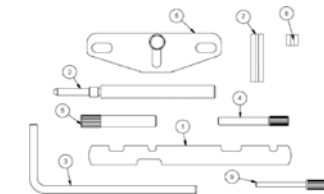

ART.	OEM
1	4880050 303-376B
2	4880070 21-104, 303-193
3	4880068 303-1059
4	4880096 303-735, 21-263
5	4880064 303-734, 21-262
6	4880061 303-393, 21-168
7	4880062 303-393-01
8	4880063 303-393-02
9	4880090 303-732, 21-260

829044
KIT DI MESSA IN FASE MOTORI FORD/VOLVO A BENZINA - 1,25/1,4/1,6/1,8/2,0



FORD
€ 52,83

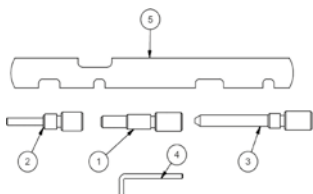

ART.	OEM
1	4880049 21-163, 303-574
2	4880051 21-210, 303-507
3	4880052 21-259, 303-748
4	4880274 303-1054
5	4880050 303-376B

829047
KIT DI MESSA IN FASE MOTORI SCTI ECOBOOST A BENZINA - 2,0



FORD
€ 149,18

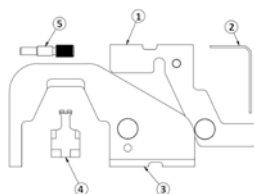

ART.	OEM
1	4880245 303-1565
2	4880248 -
3	4880278 303-1504
4	4880281 303-1521
5	4880049 303-748

829050
KIT DI MESSA IN FASE MOTORI E POMPA DEL CARBURANTE FORD/LOV DIESEL - 2,0/



FORD
€ 329,23

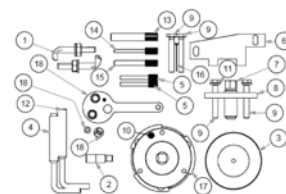

ART.	OEM
1	4880240 303-249-01
2	4880241 303-249-01
3	4880296 303-682
4	4880066 303-698
5	4880091 -
6	4880279 303-705, 303-1093
7	4880014 303-249-01
8	4880013 303-249
9	4880331 -
10	4880191 303-679
11	4880047 -
12	4880065 303-675
13	4880064 303-734
14	4880090 303-732
15	4880096 303-735
16	4880144 -
17	4880190 303-1151
18	4880273 303-1587

829045
KIT DI MESSA IN FASE MOTORI FORD A BENZINA 16V CON VCT - 1.6



FORD
€ 62,46

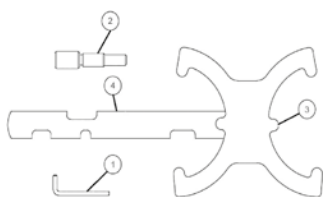

ART.	OEM
1	4880274 303-1054
2	4880049 303-748
3	4880069 303-1097
4	4880050 303-376B

829048
KIT DI MESSA IN FASE MOTORI FORD/VOLVO SCTI ECOBOOST A BENZINA - 1,6



FORD
€ 76,95

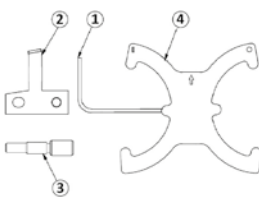

ART.	OEM
1	4880249 303-1054
2	4880270 303-1550, 999-7431
3	4880049 303-748, 999-7406
4	4880069 303-1097, 999-7429

829051
KIT DI MESSA IN FASE MOTORI FORD A BENZINA GTDI ECOBOOST - 1,0



FORD
€ 480,14

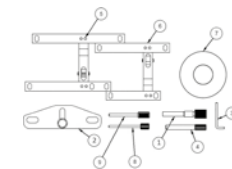

ART.	OEM
1	4880253 303-1604
2	4880254 303-1602
3	4880274 303-1054
4	4880096 Perno di bloccaggio 8mm
5	4880242 303-1605/1
6	4880243 303-1606/2
7	4880238 303-1603
8	4880121 Perno di bloccaggio 8mm
9	4880084 303-732

829046
KIT DI MESSA IN FASE MOTORI MAZDA/FORD A BENZINA - 1,8/2,0/2,3



FORD
€ 101,98

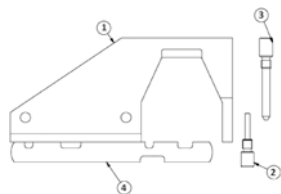

ART.	OEM
1	4880267 49 UN30 310610, 303-1061
2	4880051 999 7152/49JE01 061, 303 507, 21-210
3	4880052 49N010 101/MOT 1430 303 620, 999 7201, 21-163
4	4880050 999 7151, 303 376, 49JE01 054, 303 367//21 162, 49UN30 3376

829049
KIT DI MESSA IN FASE MOTORI FORD PSA DIESEL TDCI HI 1,4/1,6



FORD
€ 46,57

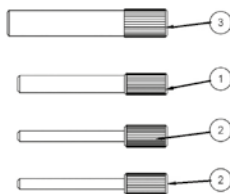

ART.	OEM
1	4880091 Perno di bloccaggio 8mm 2 pz.
2	4880066 303-698 / 21-251
3	4880273 303-1587

829052
KIT SETTAGGIO VALVOLE FORD A BENZINA VCT ECOBOOST - 1,0

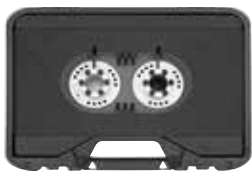

FORD
€ 324,72

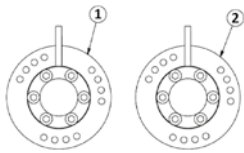

ART.	OEM
1 4880246	303-1606-1
2 4880247	303-1606-2

829094
ATTREZZO PER SOSTEGNO VOLANO FORD BENZINA/DIESEL



FORD
€ 55,15

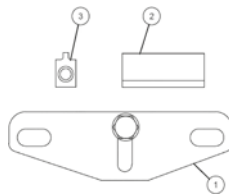

ART.	OEM
1 4880061	21-168 A, 303-393A
2 4880062	303-393-02
3 4880063	303-393-01

829107
PIASTRA DI ALLINEAMENTO POMPA OLIO FORD/JAGUAR LAND ROVER/PSA DIESEL



FORD
€ 7,98



A l'uso del 829107 richiede l'uso aggiuntivo di strumenti di bloccaggio e messa in fase del motore, non forniti in questo kit

ART.	OEM
A 829107	303-705, 303-1093, 0198.H

829063
KIT DI MESSA IN FASE MOTORI OPEL/FIAT/FORD/PSA DIESEL JTD/HDI - 1,3



FORD
€ 106,46

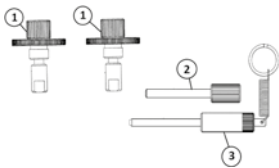

ART.	OEM
1 4880072	7099-TM
2 4880112	0188K, 0132AK, 0153AK, 0187J, 4533-TAD
3 4880113	0188P, 7015-T, 0188P2

829095
ESTRATTORE POMPA BENZINA AD ALTA PRESSIONE DIESEL FORD -TDCI - PUMA 2,2



FORD
€ 71,59

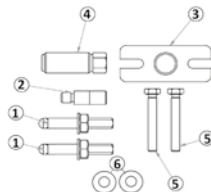

ART.	OEM
1 4880240	303-249-01
2 4880241	303-249-01
3 4880013	303-249
4 4880014	303-249-01
5 4880219	303-249
6 4880047	999 5382

829088
STRUMENTO DI TENUTA ALBERO MOTORE FIAT/FORD/OPEL DIESEL JTD - 1,3



FORD
€ 61,13

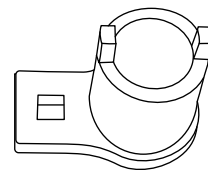

ART.	OEM
1 829088	1871 008 600 303-1475

829089
STRUMENTO DI CONTROLLO TENUTA ALBERO MOTORE VOLVO/FORD



FORD
€ 44,86



ART.	OEM
1 829089	999 5433, 303-1179

829106
SINCRONIZZATORE ALBERO A CAMME FORD PETROL ECOBOOST - 1.6



FORD
€ 24,51



A l'uso del 829106 richiede l'uso aggiuntivo di strumenti di bloccaggio e messa in fase del motore, non forniti in questo kit

ART.	OEM
1 829100	T10020//Matra V159

829053
KIT DI MESSA IN FASE MOTORI HONDA A BENZINA SOHC/DOHC - 1,6/1,8/2,0/2,2/2,3/3,0



HONDA
€ 32,16

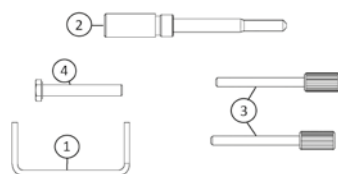

ART.	OEM
1 4880236	14540-P13-003
2 4880001	07LAG-PT20100 / 18G1671
3 4880090	07744-0010400
4 4880073	-

Iveco

Jaguar

829018
KIT DI MESSA IN FASE MOTORI
FIAT/PSA/IVECO JTD DIESEL - 2.8

IVECO
€ 99,63

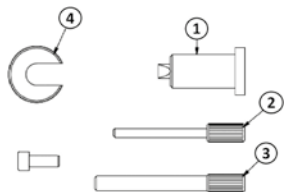

ART.	OEM
1 4880237	1 870 765 001
2 4880090	Perno di bloccaggio 4mm
3 4880097	Perno di bloccaggio 8mm
4 4880132	1 860 638 000

829037
KIT DI MESSA IN FASE MOTORI JAGUAR LAND ROVER DIESEL
TDV6 - 2,7

JAGUAR
€ 145,70

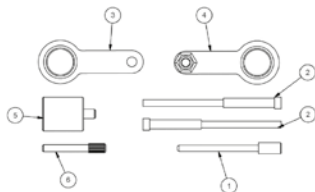

ART.	OEM
1 4880127	303-1132
2 4880079	303-1126
3 4880129	303-1116
4 4880128	303-1117
5 4880077	0195-K
6 4880078	0195-C

829026
KIT DI MESSA IN FASE MOTORI
FIAT/PSA/OPEL/IVECO JTD DIESEL - 2,5

IVECO
€ 35,83

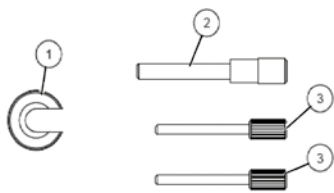

ART.	OEM
1 4880132	1 860 638 000
2 4880095	1 870 667 000, 1 870 765 001
3 4880090	1 860 617 000

829040
KIT DI MESSA IN FASE MOTORI JAGUAR LAND ROVER/FORD/PSA
DIESEL DW12 - 2,2

JAGUAR
€ 93,28

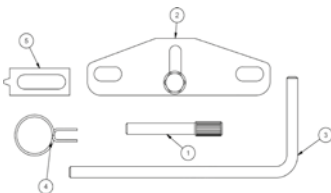

ART.	OEM
1 4880096	303-1277, 0188.M
2 4880061	303-1272, 0188.F
3 4880068	303-1270, 303-1059
4 4880080	0188AH
5 4880106	0188F

829107
PIASTRA DI ALLINEAMENTO POMPA OLIO FORD/JAGUAR LAND
ROVER/PSA DIESEL

JAGUAR

€ 7,98



A l'uso del 829107 richiede l'uso aggiuntivo di strumenti di bloccaggio e messa in fase del motore, non forniti in questo kit

ART.	OEM
A 829107	303-705, 303-1093, 0198.H

Jeep

829083
KIT DI MESSA IN FASE MOTORI
CHRYSLER/LDV DIESEL CRD - 2,5, 2,8

JEEP
€ 152,32

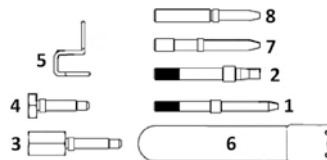

ART.	OEM
1 4880222	VM.1089, LDV196
2 4880223	VM.1068, LDV196
3 4880224	VM.1052, LDV192
4 4880225	VM.1053, LDV193
5 4880226	VM1074
6 4880015	VM.9660, H2587
7 4880282	VM.1080
8 4880283	VM.8873

829084
KIT DI MESSA IN FASE MOTORI
CHRYSLER/JEEP DIESEL CRD - 2,8

JEEP
€ 64,00

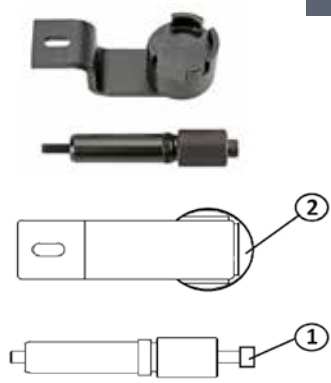

ART.	OEM
1	4880284 VM.9992
2	4880285 VM.9991

829085
KIT DI MESSA IN FASE MOTORI
CHRYSLER/JEEP DIESEL CRD - 3,0

JEEP
€ 261,99

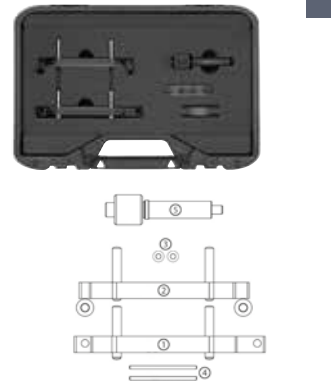

ART.	OEM
1	4880311 VM10338-1
2	4880310 VM10338-2
3	-
4	4880313 VM10359a
5	4880312 VM10339

829086
KIT DI MESSA IN FASE MOTORI MERCEDES/
CHRYSLER CRD - 2,2/2,7

JEEP
€ 202,37

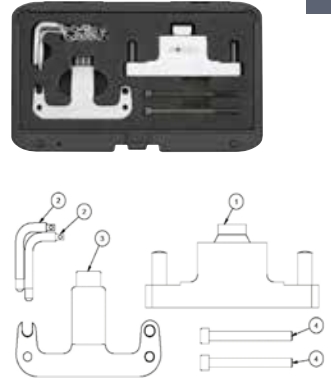

ART.	OEM
1	4880311 VM10338-1
2	4880310 VM10338-2
3	-
4	4880313 VM10359a

Mazda

829046
KIT DI MESSA IN FASE MOTORI MAZDA/FORD A BENZINA -
1,8/2,0/2,3

MAZDA
€ 101,98

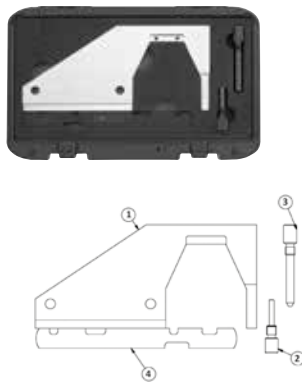

ART.	OEM
1	4880267 49 UN30 310610, 303-1061
2	4880051 999 7152/49JE01 061, 303 507, 21-210
3	4880052 49N010 101/MOT 1430 303 620, 999 7201, 21-163
4	4880050 999 7151, 303 376, 49JE01 054, 303 367//21 162, 49UN30 3376

Mercedes

829086
KIT DI MESSA IN FASE MOTORI MERCEDES/
CHRYSLER CRD - 2,2/2,7

MERCEDES
€ 202,37

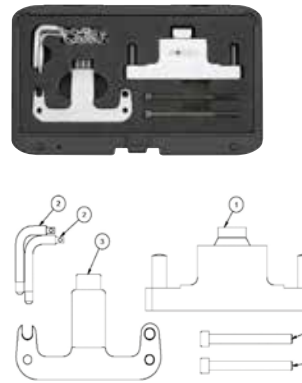

ART.	OEM
1	4880311 VM10338-1
2	4880310 VM10338-2
3	-
4	4880313 VM10359a

829120
KIT DISTRIBUZIONE VALVOLE A CAMME - MERCEDES BENZ
1,8 / 2,1 / 2,2

MERCEDES
€ 248,94

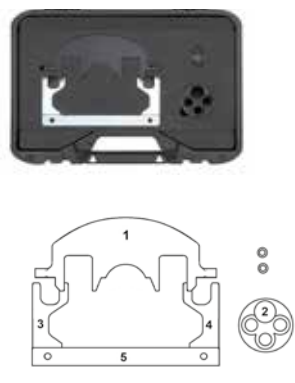

ART.	OEM
1	4880385 651 589 09 40 00, 651 589 01 40 00
2	4880315 651 589 01 40 00
3	4880314 651 158 90 26 300
4	4880314 651 158 90 26 300
5	4880314 651 158 90 26 300

829124
RACCORDO PER CATENA DI DISTRIBUZIONE - MERCEDES BENZ

MERCEDES
€ 82,20

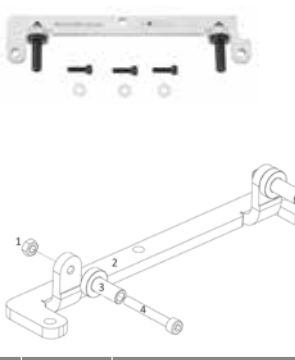

ART.	OEM
1	- 651 587 03 04 00

829134
KIT DI MESSA IN FASE MOTORI RENAULT/NISSAN/MERCEDES/
VAUXHALL 1,6D

MERCEDES
€ 166,71



ART.	OEM
1	4880359 626 589 04 40 00 MOT 1969
2	4880118 626 589 02 40 00, MOT 1770 EN956-1, EN48334
3	4880201 -
4	4880121 KM 6130
5	4880293 629 589 00 15 00, MOT 1970

Nissan

829054
KIT DI MESSA IN FASE MOTORI RENAULT/NISSAN A BENZINA (K4) - 1,6/2,0



NISSAN
€ 77,92

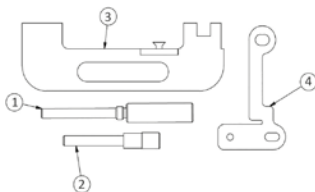

ART.	OEM
1 4880048	MOT 1489
2 4880095	MOT 1054
3 4880109	MOT 1496
4 4880111	MOT 1750

829056
KIT DI MESSA IN FASE MOTORI RENAULT/OPEL/NISSAN DIESEL (CHAIN DRIVE) - 1.6, 2.0, 2.3

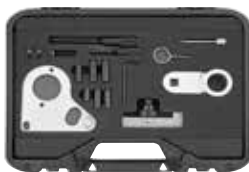

NISSAN
€ 249,78

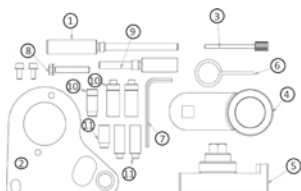

ART.	OEM
1 4880122	MOT 1766, EN48330
2 4880119	MOT 1769, EN48332, MOT 1969 (1,6L)
3 4880121	KM 6130
4 4880118	MOT 1770, KM 956-1, EN-48334
5 4880120	MOT 1773, EN48331
6 4880201	-
7 4880210	-
8 4880330	-
9 4880293	MOT 1970
10	MOT 1969
11	MOT 1769

829134
KIT DI MESSA IN FASE MOTORI RENAULT/NISSAN/MERCEDES/VAUXHALL 1,6D



NISSAN
€ 166,71

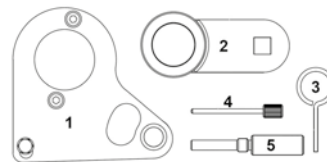

ART.	OEM
1 4880359	626 589 04 40 00 MOT 1969
2 4880118	626 589 02 40 00, MOT 1770 EN956-1, EN48334
3 4880201	-
4 4880121	KM 6130
5 4880293	629 589 00 15 00, MOT 1970

829055
KIT DI MESSA IN FASE MOTORI RENAULT/OPEL/NISSAN DIESEL (BELT DRIVE) - 1.5, 1.9, 2.2, 2.3, 2.5



NISSAN
€ 269,35

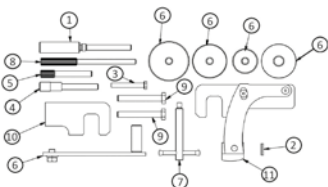

ART.	OEM
1 4880048	MOT 1489
2 4880047	-
3 4880073	-
4 4880095	MOT 1054
5 4880096	MOT 1430
6 4880116	MOT 1543
7 4880174	MOT 1538
8 4880175	MOT 1536 KM6203
9 4880177	-
10 4880178	MOT 1534 KM6205
11 4880176	MOT 1537 KM6205

829130
SET DI ATTREZZI PER BLOCCAGGIO PULEGGIA-VOLANO ANTERIORE - RENAULT / NISSAN



NISSAN
€ 178,92

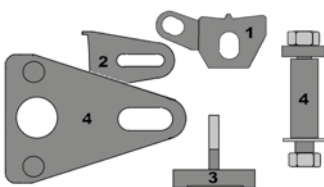

ART.	OEM
1 4880403	MOT 919-02
2 4880402	MOT.1431
3 4880414	MOT 1716
4 4880401	MOT 2019 / MOT 1789

Opel

829015
KIT DI MESSA IN FASE MOTORI FIAT/OPEL/SAAB JTD DIESEL - 1,6/1,9/2,0/2,4



OPEL
€ 105,79

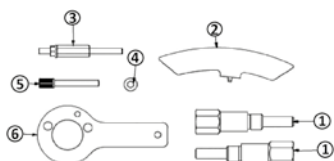

ART.	OEM
1	4880188 1.870.896.900, EN-46789, 32 025 008
2	4880136 1.860.898.000
3	4880137 -
4	4880218 -
5	4880091 1.860.965.000
6	4880187 1.860.905.000, 1.860.905.010, 2.000.003.000, EN-46788, 32 025 009

829016
KIT DI MESSA IN FASE E RIGENERAZIONE MOTORI DIESEL JTD FIAT/OPEL/FORD/PSA - 1.3



OPEL
€ 199,66

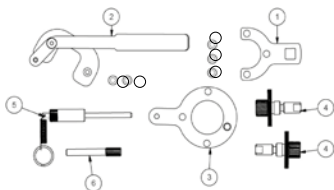

ART.	OEM
1	4880200 1 871 000 200, 303-1469, KM-662-C
2	4880004 1 870 900 400
3	4880005 0104-C, 1 870 900 300, 303-1468
4	4880183 0104-A, 1 871 000 900, 1 860 985 000, EN 46781, 09917-68610
5	4880186 EN 46785, 09912-38300
6	4880096 Perno di bloccaggio 8mm

829017
KIT DI MESSA IN FASE MOTORI OPEL/CHEVROLET/FIAT A BENZINA - 1,6/1,8 16V

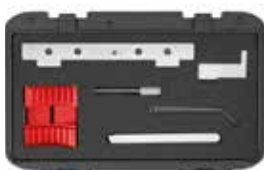

OPEL
€ 102,75

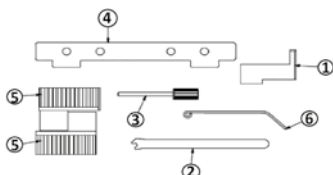

ART.	OEM
1	4880234 KM-6625
2	4880168 KM-911
3	4880185 KM6130, KM6349
4	4880239 KM-6628A, 2 000 012 000
5	4880057 KM-6340, 2 000 012 100
6	4880058 KM-6333

829022
UTENSILE DI BLOCCAGGIO ALBERO MOTORE DOPPIO OPEL/FIAT/RENAULT A BENZINA - 2,2



OPEL
€ 97,29

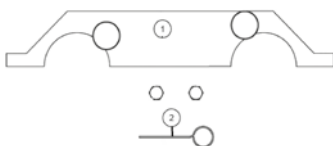

ART.	OEM
1	4880179 KM 6148
2	4880180 KM 6077

829026
KIT DI MESSA IN FASE MOTORI FIAT/PSA/OPEL/IVECO JTD DIESEL - 2,5



OPEL
€ 35,83

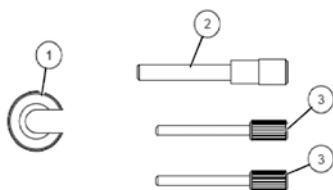

ART.	OEM
1	4880132 1 860 638 000
2	4880095 1 870 667 000, 1 870 765 001
3	4880090 1 860 617 000

829039
KIT DI MESSA IN FASE MOTORI FIAT/OPEL/FORD/PSA JTD DIESEL - 1,3



OPEL
€ 187,62

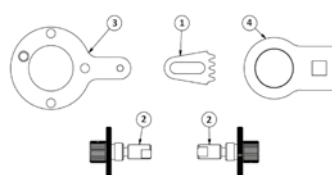

ART.	OEM
1	4880135 153A
2	4880183 21 860 985 000, EN 46781, 303-1472, 0104-A
3	4880005 1 870 900 300, 303-1468, 0104-C
4	4880280 303-1475, 1 871 008 600

829055
KIT DI MESSA IN FASE MOTORI RENAULT/OPEL/NISSAN DIESEL (BELT DRIVE) - 1.5, 1.9, 2.2, 2.3, 2.5



OPEL
€ 269,35

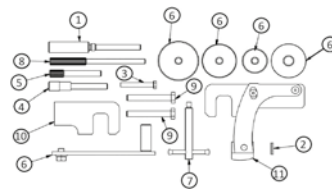

ART.	OEM
1	4880048 MOT 1489
2	4880047 -
3	4880073 -
4	4880095 MOT 1054
5	4880096 MOT 1430
6	4880116 MOT 1543
7	4880174 MOT 1538
8	4880175 MOT 1536 KM6203
9	4880177 -
10	4880178 MOT 1534 KM6205
11	4880176 MOT 1537 KM6205

829056
KIT DI MESSA IN FASE MOTORI RENAULT/OPEL/
NISSAN DIESEL (CHAIN DRIVE) - 1.6, 2.0, 2.3

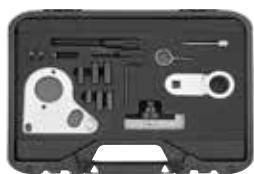

OPEL
€ 249,78

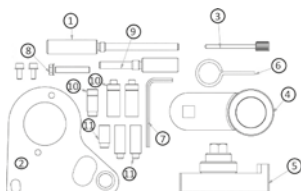

ART.	OEM
1	4880122 MOT 1766, EN48330
2	4880119 MOT 1769, EN48332, MOT 1969 (1,6L)
3	4880121 KM 6130
4	4880118 MOT 1770, KM 956-1, EN-48334
5	4880120 MOT 1773, EN48331
6	4880201 -
7	4880210 -
8	4880330 -
9	4880293 MOT 1970
10	MOT 1969
11	MOT 1769

829061
KIT DI MESSA IN FASE MOTORI OPEL/CHEVROLET DIESEL
(Z20) - 2,0



OPEL
€ 96,56

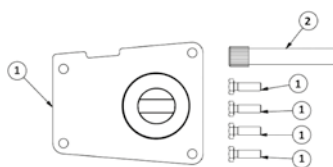

ART.	OEM
1	4880012 EN-48245
2	4880011 EN-48246

829062
KIT DI MESSA IN FASE MOTORI OPEL/RENAULT/SAAB DIESEL
DOHC CDTI - 1.9



OPEL
€ 104,59

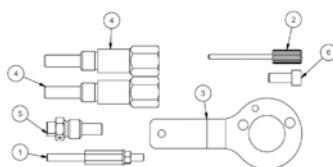

ART.	OEM
1	4880137 EN-46788
2	4880185 KM-6130, 6349
3	4880187 EN-46788/1, 32 025 009
4	4880188 EN-46789, 32 025 008
5	4880189 EN-46789-100
6	4880332 SSM8x20B

829063
KIT DI MESSA IN FASE MOTORI OPEL/FIAT/
FORD/PSA DIESEL JTD/HDI - 1,3



OPEL
€ 106,46

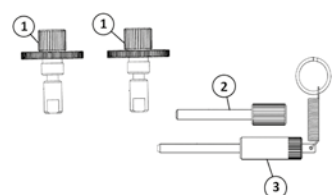

ART.	OEM
1	4880183 104-A, EN 46781
2	4880186 -
3	4880096 EN-46785

829064
KIT DI MESSA IN FASE MOTORI OPEL/CHEVROLET/SAAB A
BENZINA (A20/A24) - 2,0, 2,4



OPEL
€ 384,77

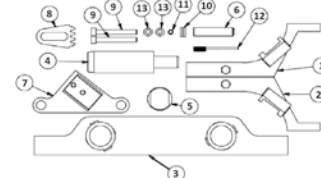

ART.	OEM
1	4880231 EN-49212, EN-49212-1
2	4880232 EN-49212, EN-49212-2
3	4880317 EN-48953
4	4880318 EN-48585
5	4880320 J45027-2, EN45027-2, EN-45027,
6	4880321 EN-45027-1, J-45027-1
7	4880319 EN-43653, J43653
8	4880135 EN-43653, J43653
9	4880214 -
10	4880010 -
11	4880173 EN-955-20, KM 955-20
12	4880172 EN-955-10, KM955
13	4880215 -

829060
KIT DI MESSA IN FASE MOTORI OPEL A BENZINA (CHAIN DRIVE
DOHC) (A12/A14) - 1.2, 1.4



OPEL
€ 260,45

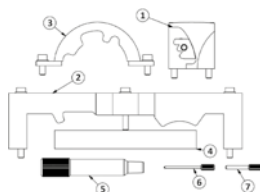

ART.	OEM
1	4880276 EN-49977-200
2	4880244 EN-49977-100
3	4880277 EN-49978
4	4880170 KM-953-A
5	4880171 KM-952
6	4880173 KM-955-2
7	4880172 KM-955-1

829065
KIT ALLINEAMENTO ALBERO A CAMME OPEL/SAAB A BENZINA
TURBO (Z20/B20) - 2,0



OPEL
€ 146,67

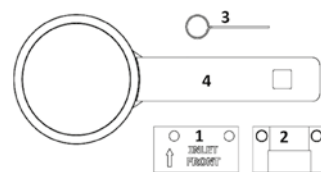

ART.	OEM
1	4880298 KM-6362-1 EN-48366-001
2	4880299 KM-6362-2 EN-48366-002
3	4880180 KM-6077 83 96 392
4	4880230 KM-J-38122-A 83 96 210

829088
STRUMENTO DI TENUTA ALBERO MOTORE FIAT/FORD/OPEL
DIESEL JTD - 1,3



OPEL
€ 55,80

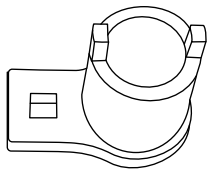

ART.	OEM
1 829088	1 871 008 600 303-1475

829091
STRUMENTO DI CONTROLLO TENUTA ALBERO MOTORE OPEL
2.0/2.2



OPEL
€ 59,60

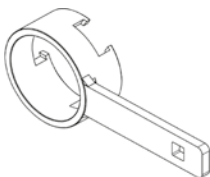

ART.	OEM
1 4880230	KM-J-38122-A

829134
KIT DI MESSA IN FASE MOTORI RENAULT/NISSAN/MERCEDES/
VAUXHALL 1,6D



OPEL
€ 152,00

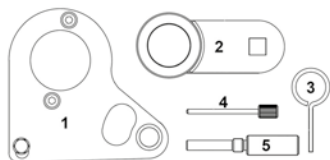

ART.	OEM
1 4880359	626 589 04 40 00 MOT 1969
2 4880118	626 589 02 40 00, MOT 1770 EN956-1, EN48334
3 4880201	-
4 4880121	KM 6130
5 4880293	629 589 00 15 00, MOT 1970

PSA Peugeot Citroën

829016
KIT DI MESSA IN FASE E RIGENERAZIONE MOTORI DIESEL JTD
FIAT/OPEL/FORD/PSA - 1.3



PSA
€ 199,66

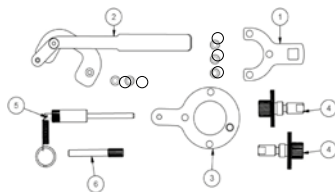

ART.	OEM
1 4880200	1 871 000 200, 303-1469, KM-662-C
2 4880004	1 870 900 400
3 4880005	0104-C, 1 870 900 300, 303-1468
4 4880183	0104-A, 1 871 000 900, 1 860 985 000, EN 46781, 09917-68610
5 4880186	EN 46785, 09912-38300
6 4880096	Perno di bloccaggio 8mm

829018
KIT DI MESSA IN FASE MOTORI FIAT/PSA/IVECO JTD DIESEL - 2.8



PSA
€ 99,63

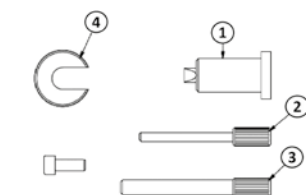

ART.	OEM
1 4880237	1 870 765 001
2 4880090	1 860 617 000
3 4880097	Perno di bloccaggio 8mm
4 4880132	1 860 638 000

829023
KIT DI MESSA IN FASE MOTORI FORD/PSA/FIAT TDCI/HDI
DIESEL - 1,4/1,5/1,6



PSA
€ 104,51

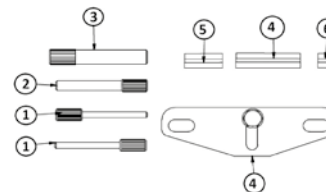

ART.	OEM
1 4880090	303-732, 21-260
2 4880096	303-735, 21-263
3 4880064	303-734, 21-262
4 4880061	303-393, 21-168
5 4880062	303-393-01
6 4880063	303-293-02

829026
KIT DI MESSA IN FASE MOTORI FIAT/PSA/OPEL/IVECO JTD
DIESEL - 2,5



PSA
€ 35,83

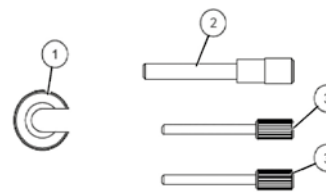

ART.	OEM
1 4880132	1 860 638 000
2 4880095	1 870 667 000, 1 870 765 001
3 4880090	1 860 617 000

829030
KIT DI MESSA IN FASE MOTORI BMW/PSA A BENZINA
N12/N14 - 1,4/1,6



PSA
€ 421,13

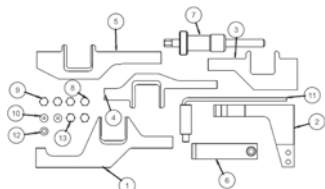

ART.	OEM
1	4880035 11 9 540 / 0197-A3
2	4880034 119540 / 0197-A3
3	4880036 11 9 540 / 0197-A1
4	4880030 11 9 550 / 0197-A2
5	4880031 11 9 551
6	4880032 11 9 552
7	4880026 11 9 340
8	4880134 -
9	4880028 -
10	4880322 -
11	4880033 11 9 590 / 0197-B
12	4880181 -
13	4880216 -

829036
KIT DI MESSA IN FASE MOTORI PSA A
BENZINA 3 CYLINDER -1,0/1,2



PSA
€ 224,59

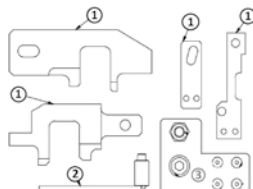

ART.	OEM
1	4880300 0109-2A
2	4880303 0109-2B
3	- -

829037
KIT DI MESSA IN FASE MOTORI JAGUAR LAND ROVER DIESEL
TDV6 - 2,7



PSA
€ 145,70

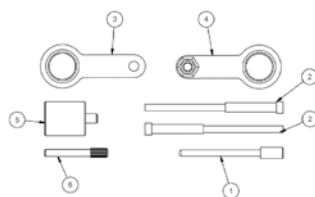

ART.	OEM
1	4880127 303-1132
2	4880079 303-1126
3	4880129 303-1116
4	4880128 303-1117
5	4880077 0195-K
6	4880078 0195-C

829035
KIT DI MESSA IN FASE MOTORI PSA A BENZINA - 1,4 16V



PSA
€ 75,28



ART.	OEM
1	4880235 0132QY
2	4880112 4533-TAD/0132-AK
3	4880228 Perno di bloccaggio 3mm
4	4880090 0194-A
5	4880096 4533-TAC1/0132-AJ1
6	4880054 0132RZ/4507-TB
7	4880053 4507-TA

829038
KIT DI MESSA IN FASE MOTORI PSA A
BENZINA (EW) - 2,0/2,2 16V



PSA
€ 172,70

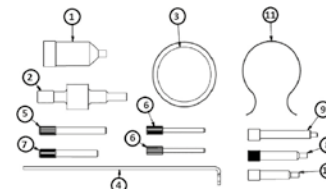

ART.	OEM
1	4880055 0189C
2	4880074 0189R
3	4880075 0189S1
4	4880076 0189S2
5	4880097 0132AJ2, 0188M, 4533TAC2
6	4880090 0132AB, 0178D, 4527-TS2
7	4880096 5711-TD
8	4880099 0189AZ
9	4880100 0189L
10	4880098 0189A
11	4880112 0188K, 0132AK, 0153AK, 0187J, 4533-TAD

829039
KIT DI MESSA IN FASE MOTORI FIAT/OPEL/FORD/PSA JTD
DIESEL - 1,3



PSA
€ 187,62

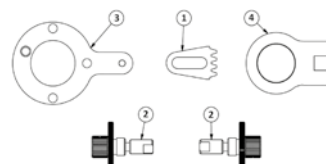

ART.	OEM
1	4880135 153A
2	4880183 21 860 985 000, EN 46781, 303-1472, 0104-A
3	4880005 1 870 900 300, 303-1468, 0104-C
4	4880280 303-1475, 1 871 008 600

829040
KIT DI MESSA IN FASE MOTORI JAGUAR LAND ROVER/FORD/PSA
DIESEL DW12 - 2,2



PSA
€ 93,28

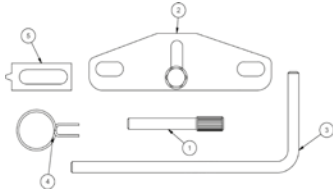

ART.	OEM
1 4880096	303-1277, 0188.M
2 4880061	303-1272, 0188.F
3 4880068	303-1270, 303-1059
4 4880080	0188AH
5 4880106	0188F

829041
KIT DI MESSA IN FASE E RIGENERAZIONE MOTORI PSA/FIAT
DW10/DW12 - 2.0/2.2



PSA
€ 223,78

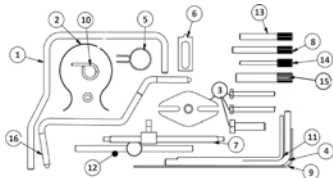

ART.	OEM
1 4880072	7099-TM
2 4880112	0188K, 0132AK, 0153AK, 0187J, 4533-TAD
3 4880113	0188P, 7015-T, 0188P2
4 4880068	303-1059
5 4880080	0188AH
6 4880106	0188F
7 4880108	0188J2
8 4880097	0188M
9 4880227	0188Q2
10 4880228	0153AL
11 4880060	0188Q1
12 4880104	0188J/J1
13 4880096	0189B
14 4880090	0178D, 303-732, 0194A
15 4880064	303-734, 0194C
16 4880255	0.532Y, 9967.34

829049
KIT DI MESSA IN FASE MOTORI FORD PSA DIESEL TOCI HI 1,4/1,6



PSA
€ 46,57

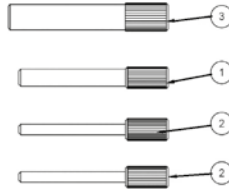

ART.	OEM
1 4880091	Perno di bloccaggio 8mm 2 pz.
2 4880066	303-698 / 21-251
3 4880273	303-1587

829063
KIT DI MESSA IN FASE MOTORI OPEL/FIAT/FORD/PSA DIESEL
JTD/HDI - 1,3



PSA
€ 106,46

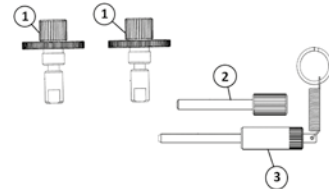

ART.	OEM
1 4880072	7099-TM
2 4880112	0188K, 0132AK, 0153AK, 0187J, 4533-TAD
3 4880113	0188P, 7015-T, 0188P2

829107
PIASTRA DI ALLINEAMENTO POMPA OLIO FORD/JAGUAR LAND
ROVER/PSA DIESEL



PSA
€ 7,98



A l'uso del 829107 richiede l'uso addizionale di strumenti di bloccaggio e messa in fase del motore, non forniti in questo kit

ART.	OEM
A 829107	303-705, 303-1093, 0198.H

829121
KIT BLOCCAGGIO CATENA DISTRIBUZIONE
PSA / BMW 1,4 / 1,6 BENZINA



PSA
€ 527,75

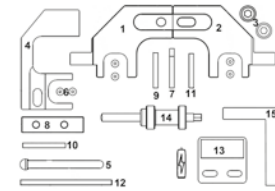

ART.	OEM
1 4880375	0197-A1/A1Z, 0197-A11, 11 7 440, 11 9 551, 11 9 540
2 4880372	0197-A2, 11 9 551
3 4880349	-
4 4880378	0197-A3, 0197-031, 11 7 440, 11 9 540
5 4880358	0197-BZ, 11 9 590, 49 6 709, 2 299 362
6 4880416	-
7 4880373	0197-A1/AZ, 11 9 540
8 4880380	Barra collegamento per A e B
9 4880377	0197-A2, 11 9 551
10 4880379	0197-A31, 11 7 440
11 4880374	0197-A11, 11 9 551, 11 9 440
12 4880379	0197-A3, 11 9 540
13 4880415	G-1376-A
14 4880371	0197-M, 11 9 340
15 4880415	E1.100

Renault Dacia

829022
UTENSILE DI BLOCCAGGIO ALBERO MOTORE DOPPIO OPEL/FIAT/
RENAULT A BENZINA - 2,2



RENAULT

€ 97,29

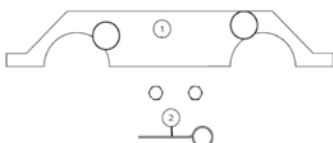

ART.	OEM
1 4880179	KM 6148
2 4880180	KM 6077

829054
KIT DI MESSA IN FASE MOTORI RENAULT/NISSAN A BENZINA
(K4) - 1,6/2,0



RENAULT

€ 77,92

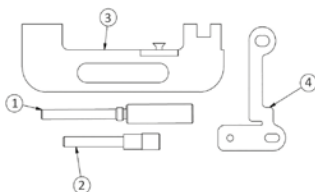

ART.	OEM
1 4880048	MOT 1489
2 4880095	MOT 1054
3 4880109	MOT 1496
4 4880111	MOT 1750

829055
KIT DI MESSA IN FASE MOTORI RENAULT/OPEL/NISSAN DIESEL
(BELT DRIVE) - 1.5, 1.9, 2.2, 2.3, 2.5



RENAULT

€ 269,35

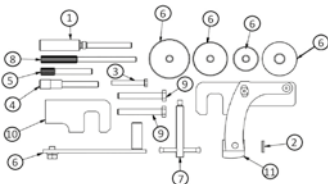

ART.	OEM
1 4880048	MOT 1489
2 4880047	-
3 4880073	-
4 4880095	MOT 1054
5 4880096	MOT 1430
6 4880116	MOT 1543
7 4880174	MOT 1538
8 4880175	MOT 1536 KM6203
9 4880177	-
10 4880178	MOT 1534 KM6205
11 4880176	MOT 1537 KM6205

829056
KIT DI MESSA IN FASE MOTORI RENAULT/OPEL/NISSAN DIESEL
(CHAIN DRIVE) - 1.6, 2.0, 2.3



RENAULT

€ 249,78

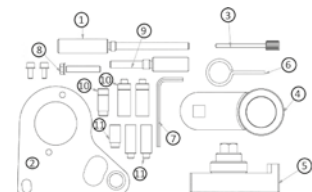

ART.	OEM
1 4880122	MOT 1766, EN48330
2 4880119	MOT 1769, EN48332, MOT 1969 (1,6L)
3 4880121	KM 6130
4 4880118	MOT 1770, KM 956-1, EN-48334
5 4880120	MOT 1773, EN48331
6 4880201	-
7 4880210	-
8 4880330	-
9 4880293	MOT 1970
10	MOT 1969
11	MOT 1769

829057
KIT DI MESSA IN FASE MOTORI RENAULT/DACIA A BENZINA
(K7J/K7M) - 1,4/1,6



RENAULT

€ 90,00

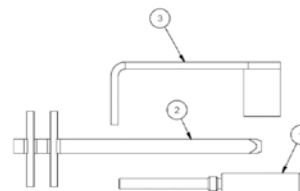

ART.	OEM
1 4880048	MOT 1489
2 4880102	MOT 1145-01
3 4880295	MOT 1501

829058
KIT DI MESSA IN FASE MOTORI RENAULT A BENZINA
(BELT DRIVE) - 1.4, 1.6, 1.8, 2.0 16V



RENAULT

€ 344,38

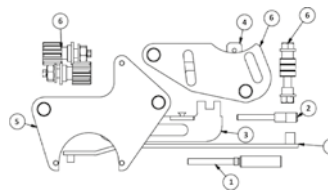

ART.	OEM
1 4880048	MOT 1489
2 4880095	MOT 1054
3 4880109	MOT 1496
4 4880111	MOT 1750
5 4880115	MOT 1490
6 4880117	MOT 1801
7 4880323	MOT 1368

829059
KIT DI MESSA IN FASE MOTORI RENAULT A BENZINA - 1,2



RENAULT

€ 90,18

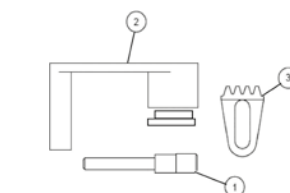

ART.	OEM
1 4880095	MOT 1054
2 4880103	MOT 1386
3 4880307	MOT 582-01

829062
KIT DI MESSA IN FASE MOTORI OPEL/RENAULT/SAAB DIESEL
DOHC COTI - 1.9



RENAULT
€ 104,59

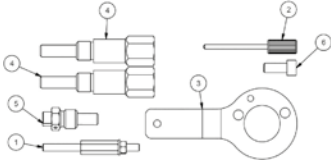

ART.	OEM
1	4880137 EN-46788
2	4880185 KM-6130, 6349
3	4880187 EN-46788/1, 32 025 009
4	4880188 EN-46789, 32 025 008
5	4880189 EN-46789-100
6	4880332 SSM8x20B

829082
KIT DI MESSA IN FASE MOTORI RENAULT/VOLVO A BENZINA
TWIN CAM 16V/20V - 2,0/2,4



RENAULT
€ 171,90

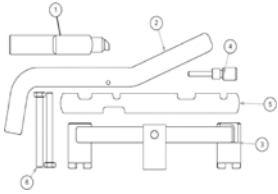

ART.	OEM
1	4880101 MOT 1340, 999 5451
2	4880105 MOT 1348
3	4880107 MOT 1337, 999 5452
4	4880051 303-507, 999 7152
5	4880050 303-376B
6	-

829130
SET DI ATTREZZI PER BLOCCAGGIO PULEGGIA-VOLANO
ANTERIORE - RENAULT / NISSAN



RENAULT
€ 178,92

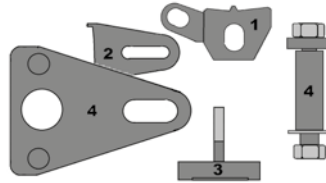

ART.	OEM
1	4880403 MOT 919-02
2	4880402 MOT.1431
3	4880414 MOT 1716
4	4880401 MOT 2019 / MOT 1789

829134
KIT DI MESSA IN FASE MOTORI RENAULT/
NISSAN/MERCEDES/VAUXHALL 1,6D



RENAULT
€ 166,71

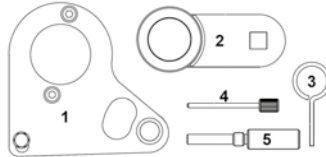

ART.	OEM
1	4880359 626 589 04 40 00 MOT 1969
2	4880118 626 589 02 40 00.MOT 1770 EN956-1, EN48334
3	4880201 -
4	4880121 KM 6130
5	4880293 629 589 00 15 00.MOT 1970

Rover Land Rover

829037
KIT DI MESSA IN FASE MOTORI JAGUAR LAND ROVER DIESEL
TDV6 - 2,7



ROVER LAND ROVER
€ 145,70

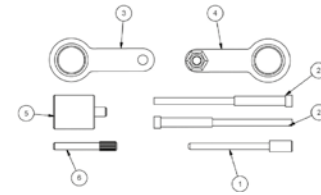

ART.	OEM
1	4880127 303-1132
2	4880079 303-1126
3	4880129 303-1116
4	4880128 303-1117
5	4880077 0195-K
6	4880078 0195-C

829040
KIT DI MESSA IN FASE MOTORI JAGUAR LAND ROVER/FORD/PSA
DIESEL DW12 - 2,2

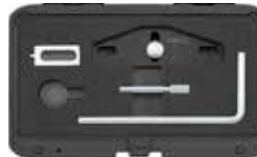

ROVER LAND ROVER
€ 93,28

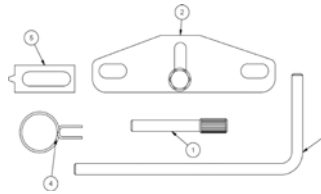

ART.	OEM
1	4880096 303-1277, 0188.M
2	4880061 303-1272, 0188.F
3	4880068 303-1270, 303-1059
4	4880080 0188AH
5	4880106 0188F

829107
PIASTRA DI ALLINEAMENTO POMPA OLIO FORD/JAGUAR LAND ROVER/PSA DIESEL

ROVER LAND ROVER

€ 7,98



A



A l'uso del 829107 richiede l'uso addizionale di strumenti di bloccaggio e messa in fase del motore, non forniti in questo kit

ART.	OEM
A 829107	303-705, 303-1093, 0198.H

Saab

829015
KIT DI MESSA IN FASE MOTORI FIAT/OPEL/SAAB JTD DIESEL - 1,6/1,9/2,0/2,4

SAAB

€ 105,79

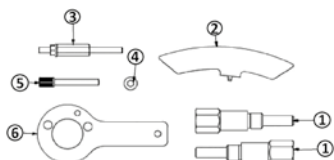

ART.	OEM
1 4880188	1.870.896.900, EN-46789, 32 025 008
2 4880136	1.860.898.000
3 4880137	-
4 4880218	-
5 4880091	1.860.965.000
6 4880187	1.860.905.000, 1.860.905.010, 2.000.003.000, EN-46788, 32 025 009

829062
KIT DI MESSA IN FASE MOTORI OPEL/RENAULT/SAAB DIESEL DOHC CDTI - 1.9

SAAB

€ 104,59

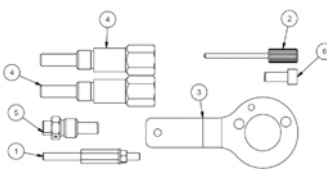

ART.	OEM
1 4880137	EN-46788
2 4880185	KM-6130, 6349
3 4880187	EN-46788/1, 32 025 009
4 4880188	EN-46789, 32 025 008
5 4880189	EN-46789-100
6 4880332	SSM8x20B

829065
KIT ALLINEAMENTO ALBERO A CAMME OPEL/SAAB A BENZINA TURBO (Z20/B20) - 2,0

SAAB

€ 146,67

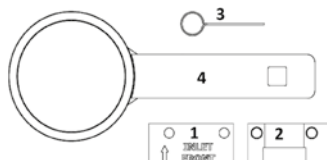

ART.	OEM
1 4880298	KM-6362-1 EN-48366-001
2 4880299	KM-6362-2 EN-48366-002
3 4880180	KM-6077 83 96 392
4 4880230	KM-J-38122-A 83 96 210

829091
STRUMENTO DI CONTROLLO TENUTA ALBERO MOTORE OPEL 2.0/2.2

SAAB

€ 65,36

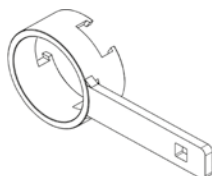

ART.	OEM
1 4880230	KM-J-38122-A

829064
KIT DI MESSA IN FASE MOTORI OPEL/CHEVROLET/SAAB A BENZINA (A20/A24) - 2,0, 2,4

SAAB

€ 384,77

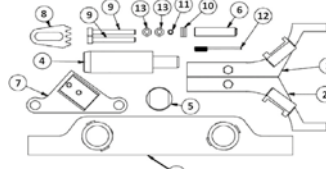

ART.	OEM
1 4880231	EN-49212, EN-49212-1
2 4880232	EN-49212, EN-49212-2
3 4880317	EN-48953
4 4880318	EN-48585
5 4880320	J45027-2, EN45027-2, EN-45027,
6 4880321	EN-45027-1, J-45027-1
7 4880319	EN-43653, J43653
8 4880135	EN-43653, J43653
9 4880214	-
10 4880010	-
11 4880173	EN-955-20, KM 955-20
12 4880172	EN-955-10, KM955
13 4880215	-

Suzuki

829055
KIT DI MESSA IN FASE MOTORI RENAULT/OPEL/NISSAN DIESEL (BELT DRIVE) - 1.5, 1.9, 2.2, 2.3, 2.5

SUZUKI

€ 269,35

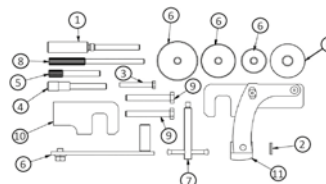

ART.	OEM
1 4880048	MOT 1489
2 4880047	-
3 4880073	-
4 4880095	MOT 1054
5 4880096	MOT 1430
6 4880116	MOT 1543
7 4880174	MOT 1538
8 4880175	MOT 1536 KM6203
9 4880177	-
10 4880178	MOT 1534 KM6205
11 4880176	MOT 1537 KM6205

VAG / Audi Volkswagen

829066

KIT DI MESSA IN FASE MOTORI PER FURGONI A BENZINA TFSI - 1,8/2,0



VAG
€ 290,16

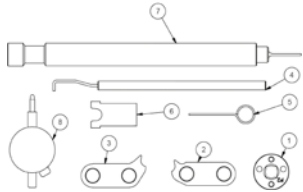

ART.	OEM
1	4880229 T10352
2	4880268 T40271-1
3	4880269 T40271-2
4	4880275 T40265
5	4880144 T40011
6	4880294 T40267
7	4880133 T10170
8	4880123 Vas6079

829067

KIT DI MESSA IN FASE MOTORI VAG A BENZINA 3 CILINDRI - 1,0



VAG
€ 126,43

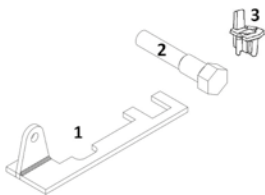

ART.	OEM
1	4880297 T10477
2	4880199 T10340
3	4880324 T10476

829068

KIT DI MESSA IN FASE MOTORI VAG DIESEL CR (2012 ON) - 1,6/2,0



VAG
€ 181,93

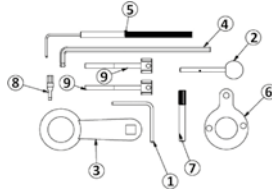

ART.	OEM
1	4880157 T10060a
2	4880092 3359
3	4880152 T10051
4	4880197 T10264
5	4880196 T10265
6	4880304 T10490
7	4880096 -
8	4880305 T10549
9	4880308 T10492

829069

KIT DI MESSA IN FASE MOTORI VAG A BENZINA TSI - 1,2/1,4



VAG
€ 74,71

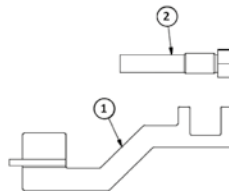

ART.	OEM
1	4880309 T10494
2	4880199 T10340

829070

KIT DI MESSA IN FASE MOTORI VAG A BENZINA 3 CILINDRI 6V/12V - 1,2



VAG
€ 127,17

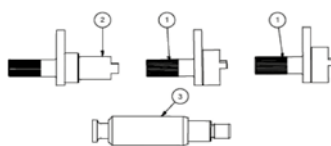

ART.	OEM
1	4880192 T10123
2	4880194 T10120
3	4880193 T10121

829071

KIT DI MESSA IN FASE MOTORI VAG A BENZINA FSI/TFSI - 1,2/1,4



VAG
€ 266,37

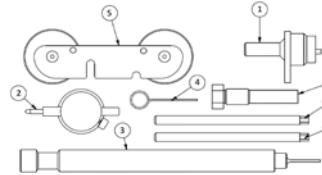

ART.	OEM
1	4880262 T10414
2	4880123 VAS 6079
3	4880133 T10170
4	4880144 T40011
5	4880159 T10171//T10171A
6	4880198 T10341
7	4880199 T10340

829072

KIT DI MESSA IN FASE MOTORI VAG DIESEL TRANSPORTER/LT - 2,4/2,5



VAG
€ 127,07

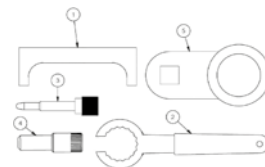

ART.	OEM
1	4880081 2065A
2	4880146 3355
3	4880145 T50009
4	4880071 2064
5	4880167 T10025

829073
KIT DI MESSA IN FASE MOTORI VAG A BENZINA FSI/TFSI - 2,0



VAG
€ 149,21

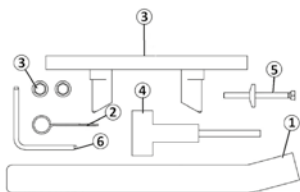

ART.	OEM
1 4880017	T10020//V.159
2 4880144	T40011
3 4880153	T10252
4 4880154	3366
5 4880155	T10092
6 4880157	T10060/A

829075
KIT DI MESSA IN FASE MOTORI VAG DIESEL V6 TDI - 2,7/3,0



VAG
€ 249,81

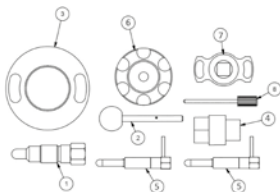

ART.	OEM
1 4880056	3242
2 4880092	3359
3 4880147	T40049
4 4880156	T40058
5 4880148	T40060
6 4880149	T40061
7 4880150	T40062
8 4880151	-

829077
KIT DI MESSA IN FASE MOTORI VAG DIESEL PD TDI - 1,2/1,4/1,9/2,0



VAG
€ 212,40

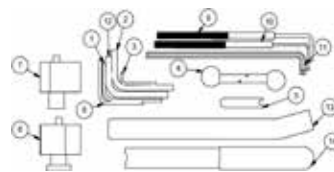

ART.	OEM
1 4880250	E10347 04
2 4880251	E10347 07
3 4880274	T10115
4 4880092	T20102, 3359
5 4880093	T10008
6 4880140	T10050
7 4880141	T10100
8 4880157	T10060
9 4880195	T40098
10 4880196	T10265
11 4880197	T10264
12 4880252	E10347 08
13 4880017	T10020 / V.159
14 4880016	T10020 / 2287

829074
KIT DI MESSA IN FASE MOTORI VAG A BENZINA FSI V6/V8 - 2,4/3,2



VAG
€ 143,15

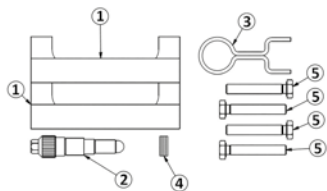

ART.	OEM
1 4880160	T40070
2 4880161	T40069
3 4880162	T40071
4 4880047	-
5 4880212	-

829076
SET PER LA REGOLAZIONE ALBERO A CAMME VAG A BENZINA 16V FSI (CINGHIA DI TRASMISSIONE) - 1,4/1,6



VAG
€ 27,69

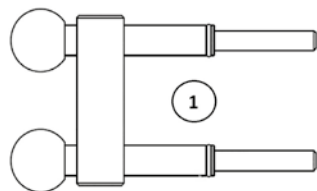

ART.	OEM
1 4880094	T10016/T10074

829078
KIT DI MESSA IN FASE MOTORI VAG A BENZINA/DIESEL - 1,7/1,9 (DIESEL), 1,6/2,0 (BENZINA)



VAG
€ 175,51

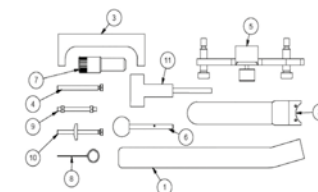

ART.	OEM
1 4880017	T10020
2 4880015	2587, MatraV159
3 4880081	2065A
4 4880142	-
5 4880158	T10098
6 4880092	T20102, 3359
7 4880071	2064
8 4880144	T40011
9 4880143	-
10 4880155	T10092
11 4880154	T20018, 3366, T20044

829090
CHIAVE TENDICINGHIA ALBERO A CAMME VAG 30MM BENZINA
 -1,0/1,2/1,4

VAG

€ 14,93

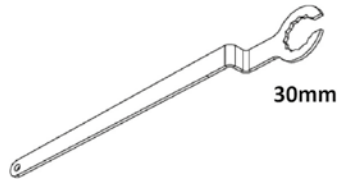

ART.	OEM
1 829090	T10499

829099
CHIAVE PER RULLO TENDICINGHIA VAG/VOLVO 32MM DIESEL
 TDI - 2,5

VAG

€ 19,32



ART.	OEM
1 4880146	3355, 999 5649, 999-5649

829108
SET ATTREZZI PER RULLO TENDICINGHIA VAG TDI PD - 1,9/2,0

VAG

€ 26,98



ART.	OEM
1 4880197	T10264
2 4880196	T10265
3 4880195	T40098

829092
CHIAVE CINGHIA DI TRASMISSIONE MOTORE
BENZINA TFSI 16MM VAG - 1,4

VAG

€ 31,76

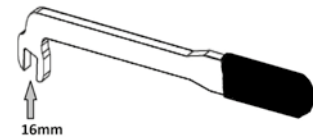

16mm

ART.	OEM
1 829092	T10447

829100
CHIAVE PER RULLO TENDICINGHIA REGOLABILE VAG

VAG

€ 34,48



ART.	OEM
1 829100	T10020//Matra V159

829109
KIT ESTRATTORE POMPA ACQUA VAG DIESEL - 2,5

VAG

€ 135,66

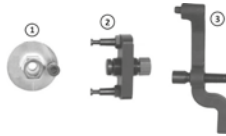

ART.	OEM
1 4880164	T10225
2 4880163	T10221A
3 4880166	T10222A

829093
LEVA REGOLAZIONE TENDICATENA VAG PETROL TFSI - 1,8/2,0

VAG

€ 58,26

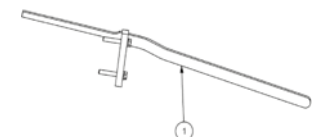

1

ART.	OEM
1 829093	T40243

829103
SET GUIDE MONTAGGIO PANNELLO ANTERIORE VW T5 VAN

VAG

€ 89,38

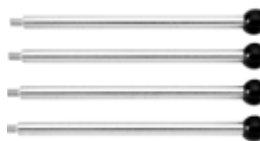

ART.	OEM
a 4880306	T10288

829115
KIT DI MESSA IN FASE MOTORI VAG 1,4/1,6/2,0I TDI CR

VAG

€ 146,37

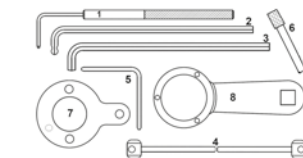

ART.	OEM
1 4880196	T10265
2 4880197	T10264
3 4880413	T10409
4 4880308	T10492
5 4880157	T100600A
6 4880096	T10490
7 4880304	T10490
8 4880152	T10051

829117
KIT DI MESSA IN FASE MOTORI VAG/PORSCHE



VAG

€ 214,72

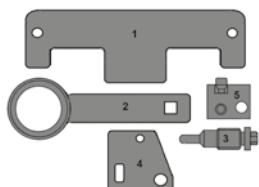

ART.	OEM
1	4880360 T10068-A
2	4880361 T10069
3	4880407 T40237
4	4880362 T10363
5	4880363 T10332

829118
KIT CINGHIA TRASMISSIONE POMPA CARBURANTE - VAG TDI 2,7 / 3,0



VAG

€ 221,83

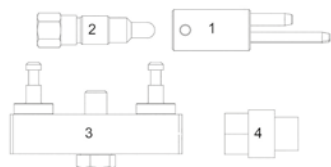

ART.	OEM
1	4880364 T40135
2	4880407 3242/T40237
3	4880365 T10320
4	4880156 T40058

829122
ATTREZZI DI FISSAGGIO PER SMORZATORE DI VIBRAZIONI - 1,8 / 2,0 TFSI / TSI



VAG

€ 279,82

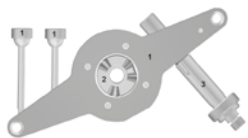

ART.	OEM
1	4880382 T10531/1
2	4880383 T10531/3
3	4880384 T10531/4 & T10531/2

829123
CHIAVE PER ATTREZZI ALBERO MOTORE - VAG



VAG

€ 80,60

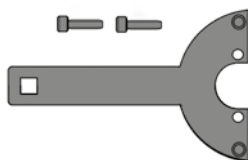

ART.	OEM
1	3415 & 3415/1

829125
KIT ALLINEAMENTO ALBERO A CAMME VAG 1,4TFSI



VAG

€ 116,80

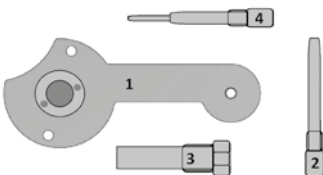

ART.	OEM
1	4880386 T10504
2	4880388 T10504/1
3	4880199 T10340
4	4880387 T10504/2

829129
KIT DI MESSA IN FASE MOTORI AUDI RS3, Q3, TT 2,5



VAG

€ 222,27

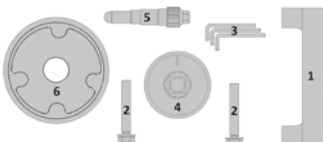

ART.	OEM
1	4880160 T40070
2	4880212 M8 X 50 Lg Bolt Din 931
3	4880274 T03006
4	4880400 T03003
5	4880161 T40069
6	4880399 T40079

Volvo

829044
KIT DI MESSA IN FASE MOTORI FORD/VOLVO A BENZINA - 1,25/1,4/1,6/1,8/2,0



VOLVO

€ 52,83

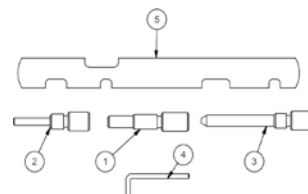

ART.	OEM
1	4880049 21-163, 303-574
2	4880051 21-210, 303-507
3	4880052 21-259, 303-748
4	4880274 303-1054
5	4880050 303-3768

829048
KIT DI MESSA IN FASE MOTORI FORD/VOLVO SCTI ECOBOOST A BENZINA - 1,6



VOLVO

€ 76,95

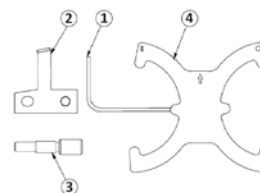

ART.	OEM
1	4880249 303-1054
2	4880270 303-1550, 999-7431
3	4880049 303-748, 999-7406
4	4880069 303-1097, 999-7429

829047
KIT DI MESSA IN FASE MOTORI SCTI ECOBOOST A
BENZINA - 2,0



VOLVO

€ 149,18

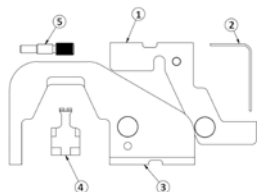

ART.	OEM
1 4880245	303-1565
2 4880248	-
3 4880278	303-1504
4 4880281	303-1521
5 4880049	303-748

829080
KIT DI MESSA IN FASE MOTORI VOLVO A BENZINA GTDI - 2,0



VOLVO

€ 216,72

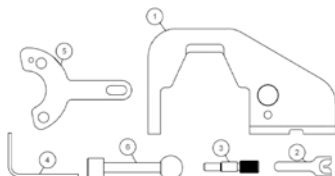

ART.	OEM
1 4880245	999 7405, 303-1504
2 4880290	999 7416
3 4880049	999 7406, 303-748
4 4880249	-
5 4880289	999 7415

829082
KIT DI MESSA IN FASE MOTORI RENAULT/
VOLVO A BENZINA TWIN CAM 16V/20V - 2,0/2,4



VOLVO

€ 171,90

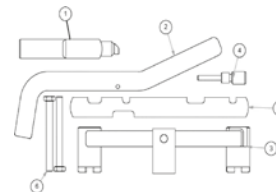

ART.	OEM
1 4880101	MOT 1340, 999 5451
2 4880105	MOT 1348
3 4880107	MOT 1337, 999 5452
4 4880051	303-507, 999 7152
5 4880050	303-376B
6 -	-

829079
KIT DI MESSA IN FASE MOTORI VOLVO DIESEL
5 CILINDRI - 2,0/2,4



VOLVO

€ 156,00

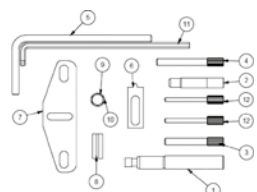

ART.	OEM
1 4880272	999-7005
2 4880271	999-7007
3 4880096	999-7122
4 4880097	999-7169
5 4880068	999-7121
6 4880106	999-7120
7 4880061	999-7119
8 -	999-7119
9 4880332	-
10 4880047	-
11 4880197	-
12 4880090	999-7233

829081
KIT DI MESSA IN FASE MOTORI VOLVO DIESEL TDCI (2011 ON) - 1,6



VOLVO

€ 16,52

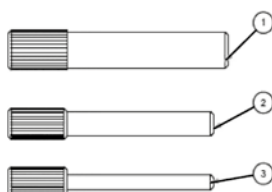

ART.	OEM
1 4880064	303-734, 999-7169
2 4880096	303-735, 999-7122
3 4880090	303-732, 999-7121

829099
CHIAVE PER RULLO TENDICINGHIA VAG/VOLVO 32MM DIESEL
TDI - 2,5



VOLVO

€ 19,32



ART.	OEM
1 4880146	3355, 999 5649, 999-5649

829089
STRUMENTO DI CONTROLLO TENUTA ALBERO MOTORE
VOLVO/FORD



VOLVO

€ 44,86



ART.	OEM
1 829089	999 5433, 303-1179

**SEGUICI SU
I SOCIAL MEDIA**



 [sonic.equipment](https://www.instagram.com/sonic.equipment)



 [Sonic Equipment Global](https://www.facebook.com/SonicEquipmentGlobal)



 [Sonic Equipment BV](https://www.linkedin.com/company/sonic-equipment-bv)



**Visualizza l'equipaggiamento
Sonic su Youtube.**



Rimani sempre aggiornato sulle nostre notizie, consigli, aggiornamenti e offerte di prodotti eccezionali. Iscriviti alla nostra pagina/newsletter.
<https://sonic-equipment.com/it/newsletter-1>



**WORK
EFFICIENT
WORK
WITH SONIC**







ARE YOU READY?

Ulteriori informazioni sono disponibili nel sito web o a catalogo. Le dimensioni, i disegni e le illustrazioni contenute in questo opuscolo non possono essere utilizzate né modificate. Tutti i diritti sono riservati. Prezzi validi fino al 30 - 06 - 2022.

**WORK
EFFICIENT
WORK
WITH SONIC**

GIRBINO MASSIMILIANO
CELL. 3667 232 073
massimiliano@sonic-equipment.com

SONIC EQUIPMENT HQ
Component 114 - 116
1446 WP Purmerend
Paesi Bassi

-  Sonic Equipment
-  sonic.equipment
-  Sonic Equipment Global
-  Sonic Equipment BV

